

# Operations Management And Research

---

## DEOPR639

Edited by:  
Anup Sharma



---

**L**OVELY  
**P**ROFESSIONAL  
**U**NIVERSITY

---



# **Operations Management and Research**

**Edited By  
Anup Sharma**

## CONTENTS

<b>Unit 1:</b>	<b>Introduction to Operations Management and Research</b>	1
	<i>Anup Sharma, Lovely Professional University</i>	
<b>Unit 2:</b>	<b>Forecasting</b>	14
	<i>Anup Sharma, Lovely Professional University</i>	
<b>Unit 3:</b>	<b>Product Design and Plant Layout</b>	31
	<i>Dr. Arun Kaushal, Lovely Professional University</i>	
<b>Unit 4:</b>	<b>Plant Location Analysis</b>	56
	<i>Dr. Arun Kaushal, Lovely Professional University</i>	
<b>Unit 5:</b>	<b>Quality Management</b>	71
	<i>Dr. Arun Kaushal, Lovely Professional University</i>	
<b>Unit 6:</b>	<b>Aggregate Production Planning</b>	93
	<i>Dr. Arun Kaushal, Lovely Professional University</i>	
<b>Unit 7:</b>	<b>Inventory Management</b>	107
	<i>Dr. Arun Kaushal, Lovely Professional University</i>	
<b>Unit 8:</b>	<b>Basics of Supply Chain Management</b>	126
	<i>Dr. Arun Kaushal, Lovely Professional University</i>	
<b>Unit 9:</b>	<b>JIT and Lean Operations</b>	141
	<i>Anup Sharma, Lovely Professional University</i>	
<b>Unit 10:</b>	<b>Linear Programming</b>	152
	<i>Anup Sharma, Lovely Professional University</i>	
<b>Unit 11:</b>	<b>Assignment and Transportation Problem</b>	172
	<i>Anup Sharma, Lovely Professional University</i>	
<b>Unit 12:</b>	<b>Project Management and Queuing Theory</b>	199
	<i>Anup Sharma, Lovely Professional University</i>	
<b>Unit 13:</b>	<b>Game Theory</b>	213
	<i>Anup Sharma, Lovely Professional University</i>	
<b>Unit 14:</b>	<b>Decision Theory</b>	226
	<i>Anup Sharma, Lovely Professional University</i>	

**Unit 01: Introduction to Operations Management and Research****CONTENTS**

Objectives

Introduction

- 1.1 Goods and Services
- 1.2 Supply and Demand Balance
- 1.3 Basic Functions of a Business Organisation
- 1.4 Supply Chain and Value Addition
- 1.5 Models in Operation Management
- 1.6 About Operation Research
- 1.7 Operation Research Definition
- 1.8 History of Operation Research
- 1.9 Applications of Operation Research
- 1.10 Issues and Advances in Operations Research
- 1.11 Models in Operation Research
- 1.12 Softwares for Operation Research

Summary

Keywords

Self Assessment

Answers for Self Assessment

Review Questions

Further Readings

**Objectives**

After studying this unit, you will be able to:

- define and explain importance of operations management
- differentiate between goods & services
- understand evolution of operation research
- appreciate emerging issues in operations management and research

**Introduction**

Operations management is a discipline that originated to solve management problems in a factory environment, but since the mid-twentieth century researchers, lecturers and practitioners have begun to adapt the knowledge of the field to also support service operations.

Production and operation system is an old system of recording inventories, loans and other business transactions. Later civilizations used planning, organisation and control to build large settlements and wonders. Division and allocation of work was done to serve large markets when trade was prominent on global scale. In eighteenth century, concepts were developed to run large manufacturing units and to use interchangeable parts and machinery.

In the later phase, quality became integral part of the system. Wars resulted in depletion of funds and companies started working on efficient manufacturing practises. Cost reduction by

maintaining quality became tantra and quality control and assurance was practised. Later, service sector grew, and concepts of production were used on service sector. Presently, artificial intelligence and machine learning are shifting manufacturing to Manufacturing 4.0 which new challenges and techniques.

## 1.1 Goods and Services

Operations is a part of business organisation which is responsible for production of goods and conduction of services. Goods are the physical items which are either processed upon or are used to in production. Services are those activities which provide some value to the players in supply chain.

### Differences in Manufacturing and Services

Goods and services can be compared on many points:

Points of comparison	Manufacturing	Services
Extent of customer contact	Mostly high degree of contact	Many have high degree, but some may have very less to none.
Labour in a job	Lesser amount of labour as compared to services	High degree of labours are required except for automated services
Uniformity of inputs	Lesser variability in inputs	High variability as every customer or job has a unique situation. Assessment and flexibility is required
Productivity measurement	Easy because of relatively uniform input factors and environmental conditions	Very difficult as every job may have different levels of complexity and conditions
Quality Assurance	Easy. Variability of inputs are low so standard process implementation possible. Happens away from customers and thus scope of correction	Difficult. Variability of inputs are higher. Delivery and consumption happens at same time so lesser scope of correction
Inventory levels	Higher inventory is required. Finished goods are kept as inventory	Mostly lesser inventory than manufacturing. Services can't be stored as finished goods
Intellectual property	Easy to patent product design	Patenting a service design is difficult or not possible in many cases

### Similarities in Manufacturing and Services

Manufacturing or services may differ in what is done but similar in how it is done. Many similarities exist between goods and services like:

- To match supply and demand, forecasting is required in both manufacturing and services. Capacity planning is also required in both cases to meet production or delivery expectations.
- Management of process

- Variation in services is generally addressed by contractual assignments and outsourcing. Variation in manufacturing is addressed by maintaining buffer, contractual workers, and outsourcing.
- Monitoring and controlling of cost and productivity
- Managing supply chain
- Location planning, inventory management and quality control

## 1.2 Supply and Demand Balance

Organisations face dilemma to follow demand or maintain excess supply to service market. If any organisation focusses on supply and go for excess production, lesser demand can result in stacking of finished goods. These goods may need space for storage. Some losses like damage and pilferage may happen during storage. Most of the times organisation in this case might end up with excess inventory and push strategy might be required to move goods through markets.

On the contrary, organisations may focus on demand. These organisations may depend on estimates provided by suppliers, retailers, or distributors. As production is tuned based on estimates, chances of excess stock are minimum. Thus, organisations may have to spend less on storage and logistics. But these organisations face challenge to respond variable demand. Slow reaction might result in loss of opportunity in the market.

Thus, it becomes necessary to forecast market demand. Good forecasting might result in balancing of supply and demand. Variation from estimate might be lesser resulting in lesser cost and more effective operations.

## 1.3 Basic Functions of a Business Organisation

There are three basic functions in any organisation:



### Finance

The **Finance** function, on the other hand, is concerned with raising the money required for all business operations and the decision-making on how and where that money should be spent. The responsibilities of the finance function include:

#### Sources of finance

Decisions about the most appropriate source of finance for each activity.

#### Cash flow

The way in which money moves in and out of the business. It is important to balance and manage these flows. If too much money flows out at a given time, the firm is in danger of insolvency.

#### Credit control

The process of collecting debts and managing payments. At any given time, a firm will be owed money by its customers and may owe money to its suppliers.

## **Operations**

Marketing and operations are primary functions. **Operations** is responsible for production of goods or providing services, offered by an organisation. The responsibilities of the production department may include:

### *New product development*

In association with the marketing department

### *Research and development (R & D)*

R&D refers to systematic investigation or innovation; the outcomes of which are new or improved materials, products, devices, processes, or services. Prototypes of new products may be tested by the marketing department with potential customers.

### *Production planning*

The production department will consider the layout of the facility, the optimum location of production, the method of production, the type of machinery and so on.

### *Quality control*

The quality of the product or service is crucial if the reputation of the firm is to be maintained and enhanced.

### *Distribution*

The production department will organize the distribution of the good or service to the customers. This may be through middlemen or 'intermediaries' such as retail shops or agents or direct to the customer through e-commerce.

## **Marketing**

The **marketing** department tends to have the most direct contact with customers. It is important to realize that marketing is not the same as 'selling' but is a much broader concept. The responsibilities of the marketing department may include:

### *Researching the market*

Identifying market opportunities, examining the nature of customers and potential customers, understanding the target market for the good or service, testing consumer reaction to potential products and so on.

### *New product development*

The marketing department will often work together with the production department to develop new products and services. The marketing department will test if there is a market for the product, identify the features or characteristics that the product requires and may carry out test launches of the product in advance of the full product launch.

### *Marketing mix*

The marketing department will develop the mix of strategies that will help with selling the product. This includes the pricing of the product, the promotion, the nature of the product and the distribution channels for the product.

## **1.4 Supply Chain and Value Addition**

A supply chain is an entire system of producing and delivering a product or service, from the very beginning stage of sourcing the raw materials to the final delivery of the product or service to end-users. The supply chain lays out all aspects of the production process, including the activities involved at each stage, information that is being communicated, natural resources that are

---

**Unit 01: Introduction to Operations Management and Research**

---

transformed into useful materials, human resources, and other components that go into the finished product or service.

Different players in a supply chain are:

### **Suppliers**

They are part of inbound logistics of any organization. Purchased inputs are handled by it. This is generally an external player. Some organizations try to develop their own supplies and in that case, it may be an internal player. Activities involved here are handling of material, storage of goods, inventory control, vehicle routing and scheduling and returns. These activities add value to the raw material. For these activities, supplier can charge a premium which is indirect measure of the value added to the product.

### **Operations**

Operations or processing are manufacturing activities. These activities result in finished goods. Activities involved in this step may be machining, packaging, assembly, equipment maintenance, testing, printing, and facility operations.

### **Marketing and sales**

It is the job of marketeers and sales agents to make sure that potential customers are aware of the product and are seriously considering purchasing them. Activities associated with marketing and sales are therefore to provide a means by which buyers can purchase the product and induce them to do so. Examples: advertising, promotion, sales force, quoting, channel selection, channel relations and pricing.

### **Distributors and retailers**

Distributors are those who distribute and supply the products to other authorities. Retailers are those who sell products and services to the end customers.

It can be seen in above supply chain that each player adds a value to the input. A supplier may aggregate, sort and transport things to production. These are the values added by the supplier. Similarly, distributor and retailers add convenience by providing things near our doorsteps. Margins and commissions are meant to compensate the cost and to give some incentives for the value added in the supply chain.

## **1.5 Models in Operation Management**

A model is an abstraction of reality, a simplified representation of something. The variety of models in use is enormous. Nonetheless, all have certain common features. They are all decision-making aids and simplifications of more complex real-life phenomena. Real life involves an overwhelming amount of detail, much of which is irrelevant for any particular problem. Models omit unimportant details so that attention can be concentrated on the most important aspects of a situation.

Models are sometimes classified as physical, schematic, or mathematical:

### **Physical models**

Physical models look like their real-life counterparts. The advantage of these models is their visual correspondence with reality. Eg. Miniature car, scaled building.

### **Schematic models**

Schematic models are more abstract than their physical counterparts; that is, they have less resemblance to the physical reality. The advantage of schematic models is that they are often



relatively simple to construct and change. Moreover, they have some degree of visual correspondence. Eg. Graphs and charts.

### **Mathematical models**

Mathematical models are the most abstract: They do not look at all like their real-life counterparts. These models are usually the easiest to manipulate, and they are important forms of inputs for computers and calculators. Eg. Formulas, and symbols.

## **1.6 About Operation Research**

The high costs of technology, materials, labour, competitive pressures and so many different economic, social as well as political factors and viewpoints greatly increase the difficulty of managerial decision-making. In today's social and business environment knowledge and technology are changing rapidly, the new problems with little or no precedents continually arise. Well-structured problems are routinely optimized at the operational level of organizations, and increased attention is now focused on broader tactical and strategic issues.

All these complexities require that a decision-maker must examine a problem from both quantitative and qualitative perspective, so that data so obtained should be analyzed in both perspectives to suggest optimal solution of the problem.

To effectively address these problems and provide leadership in the advancing global age, a decision-maker cannot afford to make decisions by simply applying his personal experiences, guesswork or intuition, because the consequences of any wrong decision are serious and costly. Hence, an understanding of the applicability of quantitative methods to decision-making is of fundamental importance to decision-makers.

## **1.7 Operation Research Definition**

Some of the definitions of Operation research are:

"It is the application of scientific methods, techniques and tools to problems involving the operations of a system so as to provide those in the control of the system with optimum solutions to the problems."

"O.R. is the application of modern methods of mathematical science to complex problems involving management of large systems of men, machines, materials, and money in industry, business, government and defence. The distinctive approach is to develop a scientific model of the system incorporating measurement of factors such as chance and risk, to predict and compare the outcome of alternative decisions, strategies or controls."

"It is the application of the scientific methods by scientists and subject specialists to the study of the given operation. Its purpose is to give administration, a basis for predicting quantitatively the most effective results of an operation under given set of variable conditions and thereby to provide a sound basis for decision-making."

## **1.8 History of Operation Research**

During World War II, military operations used term "operation research". Problems faced during the World War involved strategic and tactical decisions. Due to high complexity of such problems, solutions from individuals or from a single domain expert became almost impossible. These problems involved mathematics, economics, statistics and probability theory, engineering, behavioral, and physical science. A specialized division was formed within armed forces to take strategic and tactical decisions.

Blackett's Circus group under the leadership of Prof. P M S Blackett was working with Radar Operational Research unit. This group was responsible for analysis of the coordination of radar equipment, at gun sites. This mix team approach was appreciated and adopted by other countries. Post World War, concepts were applied to solve challenges faced in Business, Research and R&D.

## 1.9 Applications of Operation Research

### Application in Logistics and Supply Chain

Managers in organization need to source raw materials from multiple suppliers. Each of these suppliers may have different lead time. Manufacturing or service delivery might get affected if any raw material is out-of-stock. Thus, planning of raw material is required, while considering cost of longer storage. Optimum stock size and lead times may give a minimum cost of operation.

Similarly, on production floor, manager may choose smaller production run but at the cost of higher number of setups and thus, higher cost of production. On the contrary, bigger production run may incur higher cost of storage. A balance between both aspects may give optimum production run.

### Application in Finance

Investment choice of an investor depends on the expected returns and the risk appetite. Investing in riskier options may give higher returns. It is never advised to keep all eggs in the same basket and thus, good investors design portfolio. Portfolio designing involves

Few more applications are listed below:

AREAS	APPLICATIONS
<b>Finance, Budgeting and Investment</b>	<ul style="list-style-type: none"> <li>• Cash flow analysis, long range capital requirement, investment portfolios, dividend policies,</li> <li>• Claim procedure, and</li> <li>• Credit policies.</li> </ul>
<b>Marketing</b>	<ul style="list-style-type: none"> <li>• Product selection, competitive actions,</li> <li>• Number of salesmen, frequencies of calling on, and</li> <li>• Advertising strategies with respect to cost and time.</li> </ul>
<b>Purchasing</b>	<ul style="list-style-type: none"> <li>• Buying policies, varying prices,</li> <li>• Determination of quantities and timing of purchases,</li> <li>• Bidding policies,</li> <li>• Replacement policies, and</li> <li>• v. Exploitation of new material resources.</li> </ul>
<b>Production Management</b>	<ul style="list-style-type: none"> <li>• Physical distribution: Location and size of warehouses, distribution centres and retail outlets, distribution policies.</li> <li>• Facilities Planning: Number and location of factories, warehouses etc. Loading and unloading facilities.</li> <li>• Manufacturing: Production scheduling and sequencing 7tabilization of produc-tion, employment, layoffs, and optimum product mix.</li> <li>• Maintenance policies, crew size.</li> <li>• Project scheduling and allocation of resources.</li> </ul>
<b>Personnel Management</b>	<ul style="list-style-type: none"> <li>• Mixes of age and skills,</li> <li>• Recruiting policies, and</li> <li>• Job assignments</li> </ul>
<b>Research and Development</b>	<ul style="list-style-type: none"> <li>• Areas of concentration for R&amp;D.</li> <li>• Reliability and alternate decisions.</li> <li>• Determination of time-cost trade off and control of development</li> </ul>

	projects.
<b>Environment Management</b>	<ul style="list-style-type: none"> <li>• Water Management.</li> <li>• Controlling Air Pollution.</li> </ul>
<b>Healthcare</b>	<ul style="list-style-type: none"> <li>• Cancer cells screening.</li> <li>• Hospitals managing ambulance and many more</li> </ul>
<b>Transportation and Logistics</b>	<ul style="list-style-type: none"> <li>• Vehicle Routing.</li> <li>• Fleet Management</li> </ul>

### **1.10 Issues and Advances in Operations Research**

There are many advances in the field of operations management. It includes investigations in the area of sustainable supply chain management; the application of OM principles to the deployment of field laboratories to address epidemics; and novel approaches to applying operations management in response to increasingly diverse requirements, circumstances, and performance criteria.

Some of the contemporary issues and advances are as followed:

#### **Healthcare**

- Identification of new methods
- Planning care procedures appropriate for different segments
- Cost-effective diagnostics
- Predicting medical requirements based on profiling
- Layout designing for a medical facility
- Capacity constraints and effective resource utilization
- Dynamic scheduling
- Maintaining effective queuing system while addressing different emergencies
- Supply depot or warehouse location planning
- Order size prediction and inventory replenishment

#### **Defense**

- Effective combat operations
- Managing logistics
- Manpower planning
- Equipment procurement
- Infrastructure requirement
- Routing of unmanned vehicles
- Location planning for military facility
- Weapons efficiency through simulations
- Attrition model through simulations
- Load optimization for carriers and tanks
- Clutter removal for landmine detection by Radar

#### **Education**

- Resource allocation and distribution to public institutions
- Efficient operations in institutions

---

*Unit 01: Introduction to Operations Management and Research*

---

- Efficiency measurement for private and public institutions
- Incentive structure designing for teaching and non-teaching staff
- Creation and location of new institutions and closing of existing one
- Budget and work load allocation within different departments

### **Engineering**

- Logistics engineering
- Supply chain management
- Quality management and productivity
- Scheduling and production planning
- Cleaner production and sustainability
- Maintenance planning
- Risk analysis
- Decision and systems analysis
- Industrial safety and health
- Optimization techniques-based artificial intelligence

These applications demonstrate that operation research can be used to make certain processes more efficient and organized. In most of the industries, optimization of resources, managing risk and simulations are now widely done using Operation research.

### **1.11 Models in Operation Research**

There exist many problems where operation research techniques are used. These techniques can be clubbed together under following models:

- Allocation models
- Inventory models
- Waiting line (or Queuing) models
- Competitive (Game Theory) models
- Network models
- Sequencing models
- Replacement models
- Dynamic programming models
- Markov-chain models
- Simulation models
- Decision analysis models

### **1.12 Softwares for Operation Research**

Multiple applications were developed to solve problems related to Operation Research. Some software can do rapid calculations and give results in the standard format. Leading software used in industry are as followed:

- Quantitative Systems for Business Plus (QSB+), Version 3.0, by Yih-long Chang and Robert S Sullivan
- Quantitative Systems for Operations Management (QSOM), by Yih-long Chang
- Value STORM: MS Quantitative Modelling for Decision Support, by Hamilton Emmons, A D Flowers, Chander Shekhar, M Khot and Kamlesh Mathur
- Excel 97 by Gene Weiss Kopf and distributed by BPB Publications, New Delhi

- Linear Interactive Discrete Optimization (LINDO)

### **Summary**

- The operations function in business organizations is responsible for producing goods and providing services. It is a core function of every business.
- Supply chains are the sequential system of suppliers and customers that begins with basic sources of inputs and ends with final customers of the system. Operations and supply chains are interdependent – one couldn't exist without the other, and no business organization could exist without both.
- Operations management involves system design and operating decisions related to product and service design, capacity planning, process selection, location selection, work management, inventory and supply management, production planning, quality assurance, scheduling, and project management.
- The historical evolution of operations management provides interesting background information on the continuing evolution of this core business function.

### **Keywords**

**Goods:** Physical items produced by business organizations.

**Services:** Activities that provide some combination of time, location, form, and psychological value

**Operations management:** The management of systems or processes that create goods and/ or provide services.

**Supply chain:** A sequence of activities and organizations involved in producing and delivering a good or service

**Lead time:** The time between ordering a good or service and receiving it.

**Agility:** The ability of an organization to respond quickly to demands or opportunities

### **Self Assessment**

1. Operations Management is required to:
  - A. Reduce or avoid product recalls
  - B. Avoid accidents
  - C. Manage resources efficiently
  - D. All of the above
2. Finance department is responsible for:
  - A. Securing financial resources at favorable price
  - B. Optimum resource allocation in organization
  - C. Investment and budgeting
  - D. All of the above
3. Marketing department is generally not responsible for:
  - A. Identification of demand
  - B. Production of goods
  - C. Selling of services
  - D. All of the above

---

*Unit 01: Introduction to Operations Management and Research*

---

4. Who all are considered supply chain partners?
  - A. Producers & Suppliers
  - B. Customers
  - C. Both A & B
  - D. Neither A nor B
  
5. Which of the following activities is/are performed by an Operations manager?
  - A. Demand forecasting
  - B. Layout designing
  - C. Production planning
  - D. All of the above
  
6. What is true about services?
  - A. Teaching is a pure service
  - B. Car servicing is a pure service
  - C. Banking is a pure service
  - D. None of the above
  
7. Which of the following are true?
  - A. Car manufacturing is mix of goods and services
  - B. Bike repair is mix of goods and services
  - C. Stone mining is mix of goods and services
  - D. All of the above
  
8. Which of the following are required in both products and services?
  - A. Forecasting demand
  - B. Capacity planning
  - C. Location planning
  - D. All of the above
  
9. If wood is converted into our chair and sold in the market what all are involved in value addition?
  - A. Converting into a plywood
  - B. Making chair out of wood
  - C. Packing off chair
  - D. All of the above
  
10. What is role of an operation manager?
  - A. Maintaining enough buffer between two processes
  - B. Coordination between labours and machines
  - C. Forecasting and judging variations
  - D. All of the above
  
11. Operations research approach is
  - A. Multi-disciplinary

- B. Scientific
  - C. Intuitive
  - D. All of the above
12. . For analyzing a problem, decision-makers should study
- A. Its qualitative aspects
  - B. Its quantitative aspects
  - C. Both (a) and (b)
  - D. Neither (a) nor (b)
13. Decision variables are
- A. Controllable
  - B. Uncontrollable
  - C. Parameters
  - D. None of the above
14. OR approach is typically based on the use of
- A. Physical model
  - B. Mathematical model
  - C. Iconic model
  - D. Descriptive model
15. The qualitative approach to decision analysis relies on
- A. Experience
  - B. Judgement
  - C. Intuition
  - D. All of the above

### **Answers for Self Assessment**

- |       |       |       |       |       |
|-------|-------|-------|-------|-------|
| 1. D  | 2. D  | 3. B  | 4. C  | 5. D  |
| 6. D  | 7. D  | 8. D  | 9. D  | 10. D |
| 11. A | 12. C | 13. A | 14. B | 15. D |

### **Review Questions**

1. Identify any five problems in your society and suggest which model can be used to address them.
2. What are three different functional areas of any organisation and how they are related?
3. What are similarities and differences in goods production and services operation? Explain them with examples.
4. What role customization plays in process planning?
5. Identify application of Operation management and research in service sector.

---

*Unit 01: Introduction to Operations Management and Research*

---

6. What is the difference between supply chain and value chain? Explain with examples.
7. Explain how supply and demand balance can be addressed through operation management?



### **Further Readings**

Goel, A., & Agarwal, R. (2021). *Operation Research*. Technical Publications.

Gu, J., Goetschalckx, M., & McGinnis, L. F. (2007). Research on warehouse operation: A comprehensive review. *European journal of operational research*, 177(1), 1-21.

Gunasekaran, A., & Ngai, E. W. (2012). The future of operations management: an outlook and analysis. *International Journal of Production Economics*, 135(2), 687-701.



## Unit 02: Forecasting

### CONTENTS

Objectives

Introduction

- 2.1 Applications of Forecasting
- 2.2 Features of Forecasting
- 2.3 Elements of Forecasting
- 2.4 Forecast based on Judgment and Opinion
- 2.5 Forecast based on Time-Series Data
- 2.6 Time Series Forecasting: Naïve Method
- 2.7 Time Series Forecasting through Averages
- 2.8 Seasonality in Data
- 2.9 Associative Forecasting Techniques
- 2.10 Concept of Forecasting Errors

Summary

Keywords

Self Assessment

Answers for Self Assessment

Review Questions

Further Readings

### Objectives

After studying this unit, you will be able to:

- appreciate the importance of forecasting
- understand and calculate forecasting error
- understand qualitative and time-series forecasting techniques
- apply associative forecasting techniques to get forecasts with higher accuracy

### Introduction

Forecasting means different things for different persons. A plant manager might refer to forecasting plant capacity requirements, a finance professional might have forecasting capital expenditures in mind such as a new fleet of trucks and human resources manager might think of forecasting personnel requirements and making associated hiring decisions. But at the very core of it, forecasting is all about predicting customer demand. After all, it is customer demand that drives capacity requirements and the need for financial or human resources.

When we speak of forecasting in a business context, we are focused on forecasting future customer demand. Forecasting is an essential business process for virtually any firm no matter where it is located or what products it sells.

Forecasting is done to identify customer demand at some future point in time. A future point in time could be tomorrow (Short-term forecast) that allows us to make short-term ordering and shipping decisions. We might also be interested in forecasting demand for next week or next month or even next year. This longer-term forecast is the basis for more strategic decisions such as capital investments.

## 2.1 Applications of Forecasting

Accounting	New product/process cost estimates, profit projections, cash management.
Finance	Equipment/equipment replacement needs, timing, and amount of funding/ borrowing needs.
Human Resources	Hiring activities, including recruitment, interviewing, and training. layoff planning, including outplacement counseling
Marketing	Pricing and promotion, e-business strategies, global competition strategies.
MIS	New/revised information systems, Internet services.
Operations	Schedules, capacity planning, work assignments, and workloads, inventory planning, make-or-buy decisions, outsourcing, project management.
Product or service design	Revision of current features, design of new products or services.

## 2.2 Features of Forecasting

Many forecasting techniques are used. These techniques differ in many aspects but still, they all have some common features. These features are:

**Causal system continuity:** It is generally assumed in all forecasting techniques that the cause behind any trend will remain the same throughout the forecast. Thus, forecasters need to ensure that this causal relationship remains the same over a period or suitable changes might be required otherwise.

**Accuracy of forecast:** No forecast can be perfect. Many elements of the forecast can be identified but randomness still exists. This randomness can't be predicted accurately and thus forecast can't be done accurately.

**Forecasting errors:** Forecasting for an individual item may result in higher errors. When group forecasting is done, positive and negative deviations of these items cancel out resulting in lesser overall forecasting errors.

**Forecasting errors and time horizon:** Forecasting assumes the causal contribution of multiple factors. This relationship changes over a period. In the short period, the effect of this change might be less on the forecast, but this gap increases over a period. A suitable time horizon should be considered wherein this gap doesn't result in unacceptable forecasting errors.



### Notes:

- A forecast is always based on some factors and the relationship should remain the same over a period
- The forecast can't be accurate but percentage accuracy can be used
- Group forecasting is always better than individual forecasting
- Forecasting errors can increase with the time horizon.

## 2.3 Elements of Forecasting

A good forecast consists of the following elements:

1. **Timely:** Forecasting gives information on which certain actions might be taken. These actions might take some time to be planned and executed. Thus, the forecasting horizon should be such that enough time is available to take the required action.

2. **Accuracy:**Forecasting can't be accurate. This is owing to randomness in data and the unpredictability of certain factors. Thus, a forecaster can't remove variation. But if the range of variation is identified then actions can be taken on forecasted numbers, after considering possible deviations.
3. **Reliable:**A forecast should be consistent. Forecasters can make necessary adjustments to forecast if the accuracy percentage remains the same over a period. But if the forecast is not reliable, this accuracy percentage can't be used for adjustments.
4. **Units of measurement:**Forecast should be expressed in meaningful units. A forecast can be of the number of units for a production manager. Same units can be translated to revenues from sales, for a finance manager
5. **Documentation and recording:** It is done to ensure that any future forecast based on a method takes the same factors and assumptions for consistent results. It is also important for the verification of forecasting techniques.
6. **Ease of understanding and usage:**Technique should be easy to understand. A technique might work in a case but it need not be the right one. Limitations of techniques should be considered to avoid misuse of the same.
7. **Cost-effectiveness:**The cost of collecting information and analyzing should be compared with the gain in accuracy and overall benefit. If the benefit outweighs the cost, the technique may be useful.



#### Notes:

- A good forecast should be timely, accurate, and reliable.
- Units of forecasting should be as per the user requirement.
- Proper documentation of forecast makes it replicable while ease of understanding ensures the right use of the technique.
- A forecast is only beneficial if benefits out-weighs cost.

## 2.4 Forecast based on Judgment and Opinion

There are two general approaches to forecasting: qualitative and quantitative. Qualitative methods consist mainly of subjective inputs, which often defy precise numerical descriptions. Quantitative methods involve either the projection of historical data or the development of associative models that attempt to utilize causal (explanatory) variables to make a forecast.

Judgmental forecasts rely on analysis of subjective inputs obtained from various sources, such as consumer surveys, the sales staff, managers and executives, and panels of experts. Quite frequently, these sources provide insights that are not otherwise available.

## 2.5 Forecast based on Time-Series Data

Many prediction problems involve a time component and thus require the extrapolation of time series data or time series forecasting. Time-series forecasting is one of the most applied data science techniques in business, finance, supply chain management, production, and inventory planning.

Forecasting involves taking models to fit historical data and using them to predict future observations. The future is forecast or estimated based on what has already happened. Time series adds a time order dependence between observations. This dependence is both a constraint and a structure that provides a source of additional information.

Time series forecasting is a technique for the prediction of events through a sequence of time. It predicts future events by analyzing the trends of the past, on the assumption that future trends will hold similar to historical trends.

Analysis of data involves understanding of underlying behavior of the series. Some of these patterns can be identified by visual inspection of the plot. One or more patterns may be present in a plot:

**Operations Management and Research**

**Trend:**It is a long-term upward or downward movement in a data series. The shift in customer demand, changes in profits, changes in sales of a product etc. account for such change.

**Seasonality:**It is a regular variation that repeats after a fixed interval. This variation may repeat in a particular month every year, a particular season every year, a particular day every week or a particular hour every day. Peak sales of grocery items on salary day of every month can be an example of the same.

**Cycles:**This is a wave-like variation that takes a longer period to repeat. These variations are generally of more than one year period. Trends in fashion, political scenarios, or cultural shifts can be considered as examples of Cyclicity.

**Irregular variation:**Certain events may give a sudden jump or drop in the trend. Favorable events may give a sudden jump and unfavorable events may result in a sudden drop. Sometimes, the effect of such an event may last for a longer interval. Such variations generally don't represent the true picture. The presence of such variation may distort the true picture and thus, should be removed from data.

**Random Variation:**Residual variation that remains after accounting for all such variation is called random variation.

These variations are demonstrated in the following diagram:

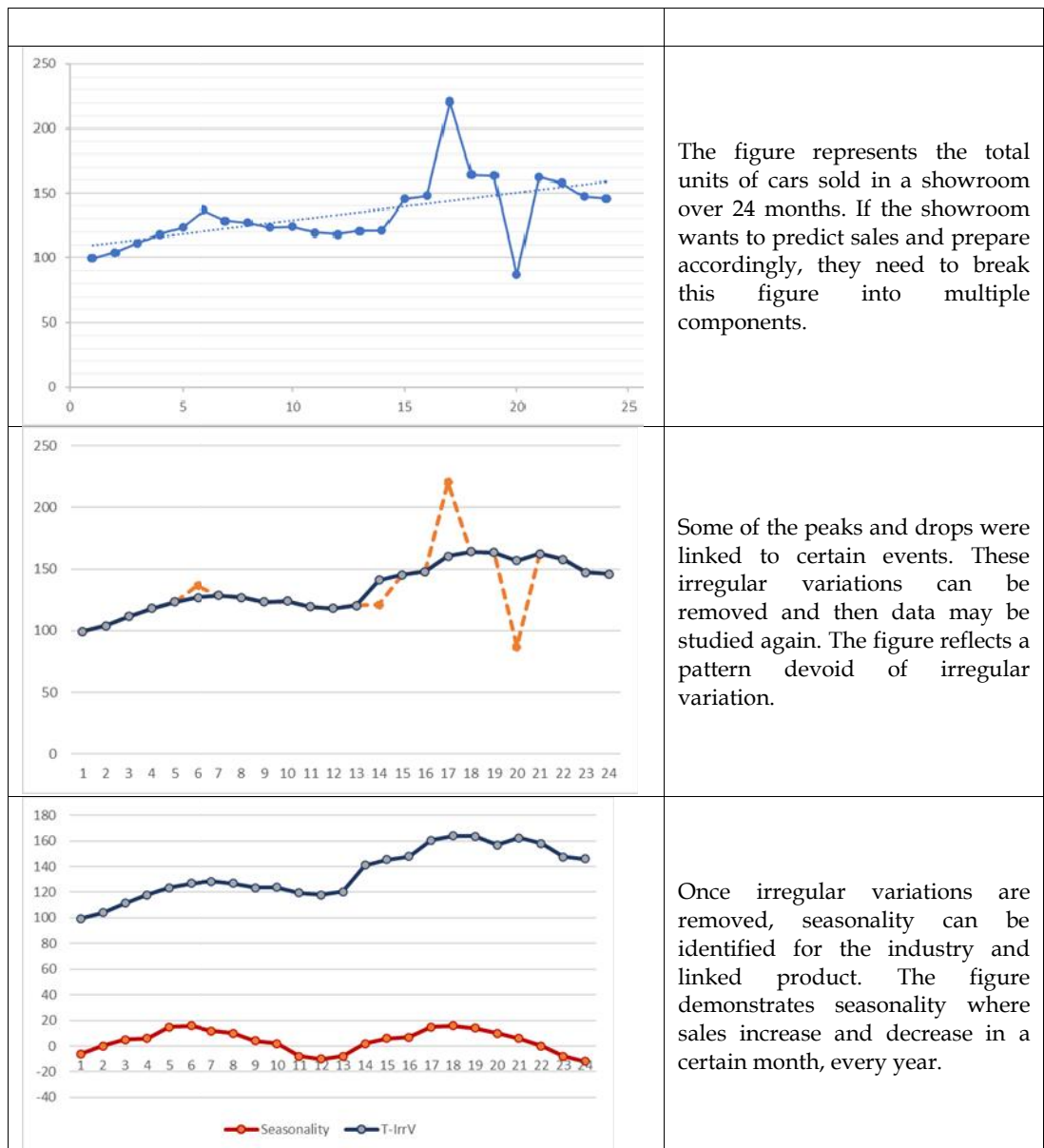

Unit 02: Forecasting

	<p>Seasonality can be removed to get a curve where random variation is present over a trend.</p>
	<p>A trend can be identified from the de-personalized data. This trend also includes random variation which can be removed from the curve</p>
<p style="text-align: center;">Random variation</p>	<p>Random variation can be studied to identify the range of this variation. Mean and standard deviation can be calculated.</p>
	<p>Forecasting for the next n-period can be done by extending the trend line till the nth period. Adding seasonality and cyclicality (if applicable) to the trend. Random variation can be added to give a range within which forecasted value may vary</p>

### 2.6 Time Series Forecasting: Naïve Method

It is a method adopted by the industry to get a quick forecast. This method considers the past few observations. Overall increase, decrease or status-quo in observations is expected to continue the trend. Forecast for immediate future is done through this method and is generally not considered reliable for a longer time frame.

A naïve method based forecast is demonstrated below:

Past observations

Forecast

Logic applied

20, 22	24	Same increase expected
25, 23	21	The same decrease expected
22, 22	22	Status-quo expected

This method has certain advantages:

- Quick estimate
- Simple calculations
- Almost no cost
- Easy to understand

In addition to these advantages, a major disadvantage is that it is less reliable due to the absence of data analysis. It is generally used as a base for comparing other forecasting techniques.

## 2.7 Time Series Forecasting through Averages

Historical data is used for forecasting. Randomness present in the trend can be because of the combined effect of multiple factors. Any randomness or irregular variation present in observations needs to be removed before applying the averages technique. This technique considers the causal trend present in the observation and the same is projected as forecast.

The averaging technique is used to smooth the curve. This technique works best when the trend varies around averages, though steep changes can also be handled. Averaging techniques are as followed:

### A. Moving Average

It considers multiple historical data for calculation, resulting in data smoothing. To calculate the average, past  $n$  observations are averaged. Value of  $n$  varies with industry and product or service within. The following equation is used to compute the moving average:

$$F_t = \sum_{i=1}^n A_{t-i} / n$$

Where,

$F_t$  =  $n$ -period moving average

$A_{t-i}$  = Actual value in period  $t-i$

$n$  = Number of periods in moving average

Consider a situation where sales of a car showroom increase gradually for 10 months. These historical values can be used to calculate 3-period moving average and can be used to do forecasting for the 11<sup>th</sup> period :



### Task

Consider a situation where sales of a car showroom increase gradually for 10 months. Sales (in '000) from Jan-Oct was: 28, 29, 32, 32, 33, 35, 39, 44, 45 and 45 respectively. Using 3 period moving average, forecast sales in November month.

Solution:

3-period moving average for April and following months can be calculated using following equation:

$$F_t = \sum_{i=1}^n A_{t-i} / n$$

Calculated values are as followed:

Month	Sales	3-n Average Forecast
Jan	28	
Feb	29	
Mar	32	
Apr	32	$28 + 29 + 32 / 3 = 29.67$
May	33	$29 + 32 + 32 / 3 = 31$
Jun	35	$32 + 32 + 33 / 3 = 32.33$
Jul	39	$32 + 33 + 35 / 3 = 33.33$
Aug	44	$33 + 35 + 39 / 3 = 35.67$
Sep	45	$35 + 39 + 44 / 3 = 39.33$
Oct	45	$39 + 44 + 45 / 3 = 42.67$
Nov		$44 + 45 + 45 / 3 = 44.67$

Sales in November is forecasted to be 44.67 thousand units.

## B. Weighted Moving Average

A weighted moving average is considered better than a simple moving average, especially for a situation where past data doesn't hold the same relevance or weightage. Last month's sales may be highly relevant as compared to the previous month's sales. Higher weightage can be assigned to last month's sales and lesser weightage to previous months.

Weights for the weighted moving average are computed from past data and its relevance with current data. Managerial discretion is considered while using these weights. The formula used for the calculation is as followed:

$$F_t = \sum_{i=1}^n W_i \cdot A_{t-i}$$

Where,

$F_t$  = n-period weighted moving average

$A_{t-i}$  = Actual value in period t-i

$W_i$  = Weightage for  $i^{\text{th}}$  period

n = Number of periods in moving average



### Task

Consider a situation where sales of a car showroom increase gradually for 10 months. Sales (in '000) from Jan-Oct was: 28, 29, 32, 32, 33, 35, 39, 44, 45 and 45 respectively. Management decides to give 50% weightage to the previous month's sales and 30% and 20% weightage to the previous 2 months.

Using 3 period weighted moving average, forecast sales in November month.

Solution:

3-period moving average for April and following months can be calculated using

following equation:

$$F_t = \sum_{i=1}^n W_i \cdot A_{t-i}$$

Calculated values are as followed:

Month	Sales	Weighted average
Jan	28	
Feb	29	
Mar	32	
Apr	32	$28 \cdot 0.5 + 29 \cdot 0.3 + 32 \cdot 0.2 = 29.1$
May	33	$29 \cdot 0.5 + 32 \cdot 0.3 + 32 \cdot 0.2 = 30.5$
Jun	35	$32 \cdot 0.5 + 32 \cdot 0.3 + 33 \cdot 0.2 = 32.2$
Jul	39	$32 \cdot 0.5 + 33 \cdot 0.3 + 35 \cdot 0.2 = 32.9$
Aug	44	$33 \cdot 0.5 + 35 \cdot 0.3 + 39 \cdot 0.2 = 34.8$
Sep	45	$35 \cdot 0.5 + 39 \cdot 0.3 + 44 \cdot 0.2 = 38$
Oct	45	$39 \cdot 0.5 + 44 \cdot 0.3 + 45 \cdot 0.2 = 41.7$
Nov		$44 \cdot 0.5 + 45 \cdot 0.3 + 45 \cdot 0.2 = 44.5$

Sales in November is forecasted to be 44.50 thousand units.

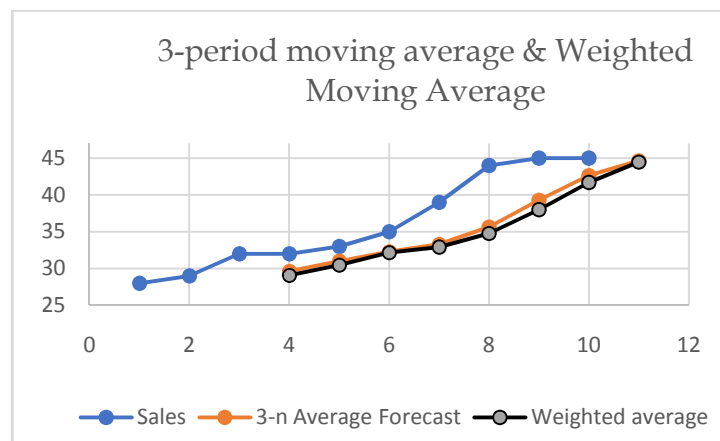

The above figure shows smoothing done through 3 periods moving average and weighted moving average. Deviation can be observed in the weighted moving average as different weights were given to the last 3 periods.

### C. Exponential Smoothing



Unit 02: Forecasting

It is an improvised weighted average method where the forecast considers the forecasting error of the previous period. A new forecast is calculated as the previous forecast plus a percentage of forecasting error (difference between forecast and actual value). The formula for the calculation is as followed:

Forecast = Previous forecast + Alpha\*(Actual - Previous forecast)

$$F_t = F_{t-1} + \alpha (A_{t-1} - F_{t-1})$$

Where,

$F_t$  = Forecast for period t

$\alpha$  = Smoothing constant

$A_{t-1}$  = Actual figure from previous term

**Task**

Consider a situation where sales of a car showroom increase gradually for 10 months. Sales (in '000) from Jan-Oct was: 28, 29, 32, 32, 33, 35, 39, 44, 45 and 45 respectively.

Considering the smoothing constant to be 0.13, plot exponential smoothing curve and forecast sales in November month.

Solution:

Exponential smoothing can be done using following equation:

$$F_t = F_{t-1} + \alpha (A_{t-1} - F_{t-1})$$

Calculated values are as followed:

Month	Sales	Expo-Forecast
Jan	28	-
Feb	29	28
Mar	32	28.1
Apr	32	28.49
May	33	28.84
Jun	35	29.26
Jul	39	29.83
Aug	44	30.75
Sep	45	32.08
Oct	45	33.37
Nov		34.53

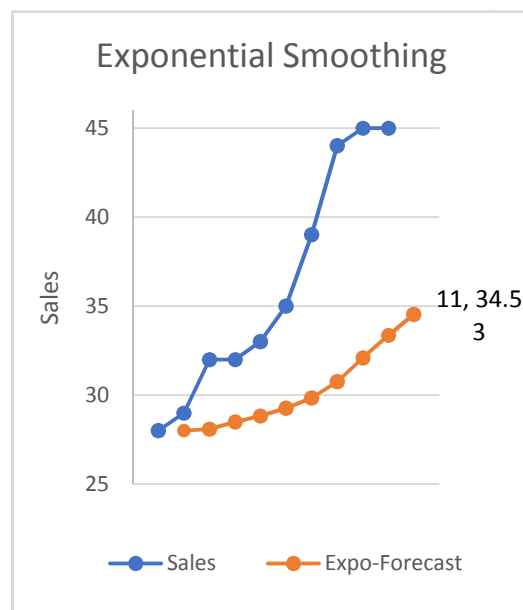

Sales in November is forecasted to be 34.53 thousand units.

**D. Trend-Adjusted Exponential Smoothing**

### Operations Management and Research

A variation of simple exponential smoothing can be used when a time series exhibits a linear trend. The trend-adjusted forecast (TAF) is composed of two elements: a smoothed error and a trend factor.

$$\text{Trend Adjusted Forecast, TAF} = \text{Smoothed Error, S} + \text{Trend estimate, T}$$

And,

$$S_t = \text{TAF}_t + \alpha (A_t - \text{TAF}_t)$$

$$T_t = T_{t-1} + \beta (\text{TAF}_t - \text{TAF}_{t-1} - T_{t-1})$$

$$\text{TAF}_{t+1} = S_t + T_t$$

Where,

$\alpha$  = Smoothing constant

$\beta$  = Trend smoothing constant

In order to use this method, one must select values of  $\alpha$  and  $\beta$  (usually through trial and error) and make a starting forecast and an estimate of trend.

## 2.8 Seasonality in Data

Seasonal variations in time-series data are regularly repeating upward or downward movements in series values that can be tied to recurring events. Seasonality in a time series is expressed in terms of the amount that actual values deviate from the average value of a series. If the series tends to vary around an average value, then seasonality is expressed in terms of that average (or a moving average); if the trend is present, seasonality is expressed in terms of the trend value.

The seasonal percentages in the multiplicative model are referred to as seasonal relatives or seasonal indexes. They are calculated as followed:

Season	Week 1	Week 2	Week 3	Season Average	SA Index
Tues	67	60	64	63.667	63.667/71.571 = 0.8896
Wed	75	73	76	74.667	74.667/71.571 = 1.0432
Thurs	82	85	87	84.667	84.667/71.571 = 1.1830
Fri	98	99	96	97.667	97.667/71.571 = 1.3646
Sat	90	86	88	88.000	88.000/71.571 = 1.2295
Sun	36	40	44	40.000	40.000/71.571 = 0.5589
Mon	55	52	50	52.333	52.333/71.571 = 0.7312
				71.571	

Seasonal data in the above case has seven seasons (days of a week). The seasonal index is calculated for each day. This seasonal index can be used to deseasonalize data as:

Week 1, Tuesday: Seasonal value = 67 De-seasonalized value = 67/0.8896 = 75.3147

Week 1, Wednesday: Seasonal value = 75 De-seasonalized value = 75/1.0432 = 71.8942

Similarly, remaining deseasonalized values can be computed and can be further used for forecasting.

## 2.9 Associative Forecasting Techniques

Associative techniques rely on the identification of related variables that can be used to predict the values of the variable of interest. It involves the development of an equation that summarizes the effects of predictor variables.

### **Simple Linear Regression:**

Modeling between the dependent and one independent variable is considered. When there is only one independent variable in the linear regression model, the model is generally termed as a simple linear regression model. When there are more than one independent variable in the model, then the linear model is termed the multiple linear regression model.

Unit 02: Forecasting

The object in linear regression is to obtain an equation of a straight line that minimizes the sum of squared vertical deviations of data points from the line (i.e., the least-squares criterion). These least-squares line has the equation:

$$Y = m.X + C$$

Where,

m = slope of the line

c = intercept of line on the y-axis

Y = Predicted variable (eg. Sales)

X = Predictor variable (eg. Advertisement expenses)

$$m = \frac{n(\sum xy) - (\sum x)(\sum y)}{n(\sum x^2) - (\sum x)^2}$$

$$c = \bar{y} - m \cdot \bar{x}$$

**Task**

Let's assume a situation where sales are affected by advertisement spending as followed:

Advertisement Spending (Lks. INR)	25	30	35	40	45	50	55	60	65	70
Sales ('000)	240	281	329	375	429	480	544	603	669	740

A relation between these two variables should be established. Manager wants to know expected sales when INR 90 Lks will be spent on advertisement.

**Solution**

Using regression formula, regression equation will be:

$$y = 11.084x - 57.473$$

Using this regression equation, x = 90 can be substituted to obtain Y.

$$Y = (11.084 \times 90) - 57.473$$

$$= 940.087$$

Thus, 90 Lks investment in an advertisement may yield sales of 940,000. The same can be represented as:

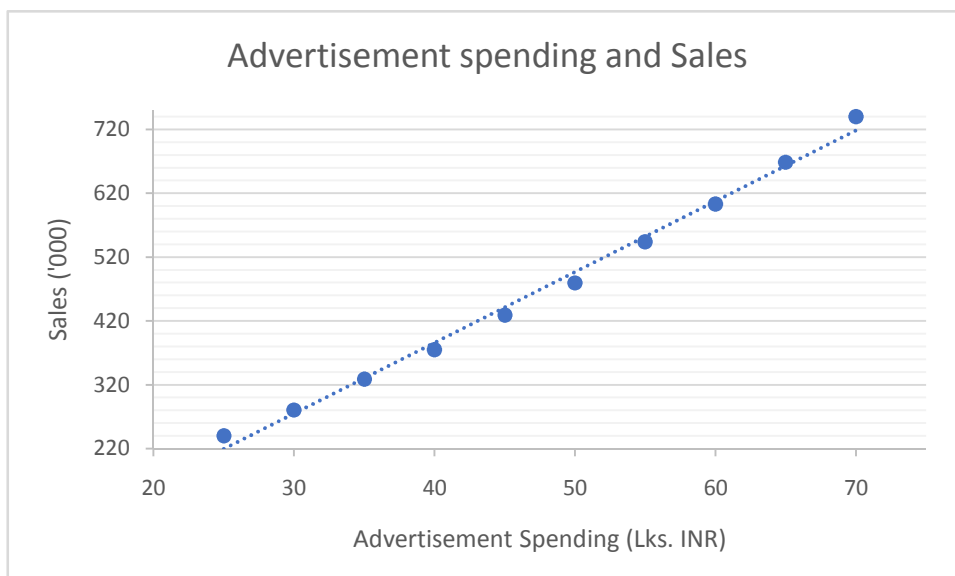

**Correlation:**

Correlation measures the strength and direction of the relationship between two variables. Correlation can range from + 1.00 to - 1.00. A correlation of + 1.00 indicates that changes in one variable are always matched by changes in the other; a correlation of - 1.00 indicates that increases in one variable are matched by decreases in the other; and a correlation close to zero indicates a little linear relationship between two variables.

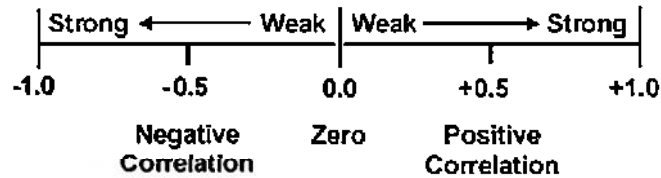

The correlation between two variables can be computed using the equation:

$$\frac{(n\sum xy - \sum x \sum y)}{(\sqrt{(n\sum x^2 - (\sum x)^2)}\sqrt{(n\sum y^2 - (\sum y)^2)})}$$

The square of the correlation coefficient,  $r^2$ , provides a measure of the percentage of variability in the values of  $y$  that is "explained" by the independent variable. A high value of  $r^2$ , say .80 or more, would indicate that the independent variable is a good predictor of values of the dependent variable. A low value, say .25 or less, would indicate a poor predictor, and a value between .25 and .80 would indicate a moderate predictor.

	CAUTION
	Correlation coefficient ( $r$ ) can range from + 1.00 to - 1.00 whereas $R^2$ varies from 0 to +1.00.

**2.10 Concept of Forecasting Errors**

Forecasting is based on a certain relation between the dependent and independent variable(s). Even with a wide set of historical data for model development, the forecast may not be accurate. Measuring these forecasting errors gives an idea of the appropriateness of the forecasting technique. Changes are made in parameters to improve forecasting accuracy.

Three different errors are calculated in forecasting. These are:

**1. Mean absolute deviation (MAD)**

The method for evaluating forecasting methods uses the sum of simple mistakes. Mean Absolute Deviation (MAD) measures the accuracy of the prediction by averaging the alleged error (the absolute value of each error). MAD is useful when measuring prediction errors in the same unit as the original series. The value of MAD can be calculated using the following formula:

For each period, Error ( $t$ ) = Actual - Forecast

$n$  = number of period

$\sum E_t$  = Sum of errors

$MAD = \sum E_t / n$

**2. Mean squared error (MSE)**

The mean squared error, or MSE, is calculated as the average of the squared forecast error values. Squaring the forecast error values forces them to be positive; it also has the effect of putting more weight on large errors.

Very large or outlier forecast errors are squared, which in turn has the effect of dragging the mean of the squared forecast errors out resulting in a larger mean squared error score. In effect, the score gives worse performance to those models that make large wrong forecasts

For each period, Error = Actual - Forecast

n = number of period

$\Sigma(E_t)^2$  = Sum of squared errors

$MSE = \Sigma(E_t)^2 / (n - 1)$

### 3. Mean absolute percent error (MAPE)

Mean Absolute Percentage Error (MAPE) is calculated using the absolute error in each period divided by the observed values that are evident for that period. Then, averaging those fixed percentages. This approach is useful when the size or size of a prediction variable is significant in evaluating the accuracy of a prediction. MAPE indicates how much error in predicting compared with the real value.

For each period, Error = Actual - Forecast

For each period, Absolute error = |Error|

For each period, Error % = (|Error| / Actual) \* 100

n = number of period

$\Sigma |E_t\%|$  = Sum of error %

$MAPE = \Sigma |E_t\%| / n$

## Summary

- Demand forecasts are essential inputs for many business decisions; they help managers decide how much supply or capacity will be needed to match expected demand, both within the organization and in the supply chain.
- Because of random variations in demand, it is likely that the forecast will not be perfect, so managers need to be prepared to deal with forecast errors.
- Other, nonrandom factors might also be present, so it is necessary to monitor forecast errors to check for nonrandom patterns in forecast errors.
- It is important to choose a cost-effective forecasting technique and one that minimizes forecast error.
- Two major quantitative approaches are analysis of time-series data and associative techniques.
- The time-series techniques rely strictly on the examination of historical data; predictions are made by projecting past movements of a variable into the future without considering specific factors that might influence the variable.
- Associative techniques attempt to explicitly identify influencing factors and to incorporate that information into equations that can be used for predictive purposes

## Keywords

**Associative model:** Forecasting technique that uses explanatory variables to predict future demand.

**Correlation:** A measure of the strength and direction of the relationship between two variables.

**Delphi method:** An iterative process in which managers and staff complete a series of questionnaires, each developed from the previous one, to achieve a consensus forecast

**Exponential smoothing:** A weighted averaging method based on previous forecast plus a percentage of the forecast error

Operations Management and Research

---

**Trend:** A long-term upward or downward movement in data.

**Seasonality:** Short-term regular variations related to the calendar or time of day.

**Cycle:** Wavelike variations lasting more than one year.

**Irregular variation:** Caused by unusual circumstances, not reflective of typical behavior.

**Random variations:** Residual variations after all other behaviors are accounted for

**Judgmental forecasts:** Forecasts that use subjective inputs such as opinions from consumer surveys, sales staff, managers, executives, and experts.

**Mean absolute deviation (MAD):**The average absolute forecast error

**Mean absolute percent error (MAPE):** The average absolute percent error.

**Mean squared error (MSE):** The average of squared forecast errors

**Moving average:** Technique that averages a number of recent actual values, updated as new values become available

**Time-series forecasts:** Forecasts that project patterns identified in recent time-series observations

**SelfAssessment**

1. What is/are the feature(s) of a forecast?
  - A. The causal relationship remains the same over a period
  - B. Forecasts are always accurate
  - C. Forecasting accuracy remains unaffected with forecasting time frame
  - D. All of the above
  
2. Which of the following is/are feature(s) of a good forecast?
  - A. Time frame
  - B. Accuracy
  - C. Reliability
  - D. All of the above
  
3. Which of the following should be considered while forecasting demand?
  - A. Time horizon
  - B. Forecasting technique
  - C. Forecasting purpose
  - D. All of the above
  
4. If forecasted demand for the current month is 2000 units with error +100 units. actual demand is:
  - A. 1900 units
  - B. 2100 units
  - C. Neither 1900 units nor 2100 units
  - D. Insufficient information
  
5. Error measurement in forecasting where higher weightage is given to bigger errors:
  - A. MAD

- B. MSE
- C. MAPE
- D. None of the above

6. Error measurement in forecasting where the perspective of error is considered:

- A. MAD
- B. MSE
- C. MAPE
- D. None of the above

7. Input(s) for qualitative forecast can be:

- A. Consumer survey
- B. Sales team opinion
- C. Subject expert opinion
- D. All of the above

8. What's true about Delphi's method of forecasting?

- A. Large historical data is required for computation
- B. Every person in the organization should be involved
- C. Bias elimination is possible
- D. None of the above

9. Seasonality in forecasting can be for:

- A. Peak operational hours
- B. Peak monthly sales days
- C. Monsoon season sales
- D. All of the above

10. Variations in forecasting where reasons for variation can be identified but not predicted in the long future:

- A. Random variations
- B. Irregular variations
- C. Trends
- D. None of the above

11. Moving average is better than simple average when:

- A. Past data has lesser relevance
- B. Present data has lesser relevance
- C. Seasonal data is considered
- D. None of the above

12. What is true for smoothing constant?

- A. It ranges from -1 to +1

Operations Management and Research

- B. Used for weighted average forecasting method  
 C. Previous errors are partially explained by the constant  
 D. None of the above
13. In trend adjusted exponential smoothing:  
 A. Alpha represents trend smoothing constant  
 B. Beta is smoothing constant  
 C. Trend adjusted forecast is the sum of trend estimate and smoothed error  
 D. None of the above is true
14. What are assumptions under simple linear regression?  
 A. Variations are random with no variation  
 B. Deviations are normally distributed  
 C. Good predictions can be done within the range of observed value  
 D. All of the above
15. Correlation coefficient of -0.2 reflects:  
 A. Negative weak correlation  
 B. Strong positive correlation  
 C. Negative strong correlation  
 D. Weak positive correlation

**Answers for Self Assessment**

1. A      2. D      3. D      4. B      5. B  
 6. C      7. D      8. C      9. D      10. B  
 11. C      12. C      13. C      14. D      15. A

**Review Questions**

- What are the main advantages that quantitative techniques for forecasting have over qualitative techniques?
- What is the Delphi technique and what are its main benefits and weaknesses?
- Contrast the use of MAD and MSE in evaluating forecasts.
- What advantages as a forecasting tool does exponential smoothing have over moving averages?
- How does the number of periods in a moving average affect the responsiveness of the forecast?
- Records during the last five weeks indicate the number of job requests:

Week:	1	2	3	4	5
Requests:	20	22	18	21	22

Predict the number of requests for week 6 using each of these methods:



- a. Naive.
  - b. A four-period moving average.
  - c. Exponential smoothing with  $\alpha = 0.30$ . Use 20 for the week 2 forecast
7. The manager of a fashionable restaurant open Wednesday through Saturday says that the restaurant does about 35 percent of its business on Friday night, 30 percent on Saturday night, and 20 percent on Thursday night. What seasonal relatives would describe this situation?
  8. Which type of forecasting approach, qualitative or quantitative, is better?
  9. Discuss how you would manage a poor forecast.
  10. An analyst must decide between two different forecasting techniques for weekly sales of rollerblades: a linear trend equation and the naive approach. The linear trend equation is  $F_t = 124 + 2t$ , and it was developed using data from periods 1 through 10. Based on data for periods 11 through 20 as shown in the table, which of these two methods has the greater accuracy if MAD and MSE are used?

t	11	12	13	14	15	16	17	18	19	20
Units Sold	147	148	151	145	155	152	155	157	160	165



### Further Readings

- Business Forecasting By John E. Hanke, Dean W. Wichern · 2009
- Sales Forecasting, A Practical Guide By Mark Blessington · 2015
- Practical Time Series Analysis, Prediction with Statistics and Machine Learning  
By Aileen Nielsen · 2019



### **Web Links**

<https://hbr.org/1971/07/how-to-choose-the-right-forecasting-technique>

<https://www.thefulfillmentlab.com/blog/demand-forecasting>

## Unit 03: Product Design and Plant Layout

### CONTENTS

Objectives

Introduction

3.1 Need/Reasons for Product and Service Design

3.2 Product Design Development Phases

3.3 Product Design for Production System

3.4 Taxonomy for Product Design

3.5 Service Design

3.6 Types of Production System

3.7 Plant Layout

3.8 Products and Services Profiling

3.9 Line Balancing

3.10 Designing the Layouts

Summary

Keywords

Self Assessment

Answers for Self Assessment

Review Questions

Further Readings

### Objectives

After studying this unit, you will be able to:

- Understand the concept of product design and service design that play a significant role in the new product development process.
- Get familiarity with identifying some key reasons for design or redesign and this will get the understanding of the strategic importance of product and service design.
- Understand the various types of production systems adopted in the operations or production department of an organization.
- Understand the concept of Plant Layout and various types of plant layouts that can be used in manufacturing organizations.

### Introduction

Product design considers not just the product itself, but also the user experience. Designing a new product involves an analytical method and a problem-solving strategy to improve the end user's quality of life and engagement with the environment. It's all about problem-solving, picturing the user's demands, and providing a solution. Other experts, such as engineers and marketers, collaborate alongside product designers. While they are not in charge of the product's primarily mechanical and technological aspects, they are concerned with usability. Medical gadgets, dinnerware, jewelry, sports and recreation, food preservation appliances, furniture, and so on are all examples of product design. It also considers the cost of production, manufacturing procedures, and regulatory requirements.

Product design is defined as the process of envisioning, developing, and iterating products that answer users' issues or meet specific market needs. Understanding the end-user customer, or the person for whom the product is being built, is critical to successful product design. Product designers use empathy and knowledge of their prospective clients' routines, behaviors, frustrations, requirements, and aspirations to solve real problems for real people. The ideal execution of product design is so faultless that no one notices; consumers may intuitively utilize the product as needed because product design anticipated their needs.

### **3.1 Need/Reasons for Product and Service Design**

The following are some of the numerous activities and responsibilities of the product and service design team that they usually manage with effective coordination of operations as well as the marketing team and other functional team of a manufacturing organization.

1. Convert consumer desires and needs into product and service specifications. (marketing, \, operations)
2. Improve current products and services. (marketing)
3. Create new items and/or services. (operations, marketing)
4. Establish quality objectives. (operations, marketing)
5. Establish cost objectives. (finance, accounting, and operations)
6. Make prototypes and test them. (operations, marketing, and engineering)
7. Create detailed requirements.

### **3.2 Product Design Development Phases**

The following are the stages of product design and development that are normally being adopted by product designers in the R & D department of a manufacturing organization

**Analyze the feasibility:** Market study (demand), economic analysis (development and production costs, profit potential), and technical analysis are all part of the feasibility analysis process (capacity requirements and availability, and the skills needed). It's also important to respond to the question, "Does it fit with the mission?" Marketing, finance, accounting, engineering, and operations must all work together.

**Product information:** This necessitates collaboration across legal, marketing, and operations to provide thorough explanations of what is required to satisfy (or exceed) consumer needs.

**Process description:** After the product specifications have been established, the focus shifts to the process specifications/descriptions that will be required to manufacture the product. Cost, resource availability, profit potential, and quality must all be considered while weighing options. This requires accounting and operations to work together.

**Development of prototypes:** Once the product and process specifications are finalized, one (or a few) units are built to see if the product or process specifications are flawed.

**Examine the design:** Any necessary revisions are made at this point, or the project is abandoned. Marketing, finance, engineering, design, and operations work together to decide whether to move forward or not.

**Test Marketing.:** To measure the level of consumer approval, a market test is used. If the product fails, it is returned to the design review stage. Marketing is in charge of this phase.

**Introduce the product:** The new item is advertised. Marketing is in charge of this phase.

**Follow-up assessment:** Changes or forecasts may be made in response to user feedback. Marketing is in charge of this phase.

### 3.3 Product Design for Production System

In this segment of the discussion about product design, you'll be able to learn about design strategies that are more appropriate for product design than for service design. Nonetheless, you will notice that they are relevant to service design like Concurrent engineering, computer-aided design, designing for assembly and disassembly, and the utilization of components for comparable products. Apart from this, Designers must be very much care of a variety of legal and ethical problems. Furthermore, if there is a risk of harming the environment, such considerations become even more essential. The majority of businesses are regulated by a variety of government authorities.

Additionally, Product liability can be a powerful motivator for better design. A manufacturer's culpability for any injuries or damages caused by a faulty product due to poor workmanship or design is known as product liability. Many companies, including Firestone Tire & Rubber, Ford Motor Company, General Motors, tobacco industries, and toymakers, have faced product liability claims. Manufacturers must also contend with implied guarantees imposed by state legislation under the Uniform Commercial Code, which states that products have an implied warranty of merchantability and fitness, meaning that they must be usable for their intended uses. Furthermore, Consumer product design frequently encounters human factor challenges. In many cases, safety and responsibility are two essential considerations that must be properly examined. Consumers, insurance firms, automobile manufacturers, and the government, for example, are all interested in vehicle crashworthiness. Another consideration for designers is the addition of new features to their goods or services. Certain businesses may seek a competitive advantage by incorporating innovative technologies too. Additionally, Designers frequently consider three areas of possible cost savings and environmental impact: decreasing the usage of resources through value analysis; remanufacturing and reselling returned goods that are assessed to have extended useful life and reclaiming pieces of unsuitable products for recycling.

*Reduce via Value Analysis:* An investigation of the function of parts and materials to lower the cost and/or improve the performance of a product is referred to as value analysis. Typical questions posed during the analysis include:

Could a less expensive item or material be used?

Is the function required?

Is it possible to combine the functions of two or more sections or components into a single part at a reduced cost?

Is it possible to simplify a component?

Could product specifications be loosened, resulting in a price reduction?

Could nonstandard parts be replaced with standard parts?

*Reuse for remanufacturing:* The remanufacturing of items is a new manufacturing concept. Remanufacturing is the process of restoring and reselling used products by replacing worn-out or damaged components. The original maker or another company can do this.



**Example:** Automobiles, printers, copiers, cameras, computers, and telephones are among the items that use remanufactured components.

*Recycling:* For some designers, recycling is a significant consideration. Recycling is the process of reclaiming resources for further use. This applies not only to manufactured parts but also to production materials like lubricants and solvents. Metal or plastic pieces that have been reclaimed can be melted down and repurposed to manufacture a variety of goods. Recycling is beneficial to businesses for a multitude of reasons, including

1. Cost savings
2. Environmental issues.
3. Environmental guidelines for some designers.

### 3.4 Taxonomy for Product Design

Apart from the above-mentioned factors, product or service designers have to consider other dimensions too that play a significant role in understanding the various practical aspects of the product design. A few of these dimensions are as follows :

- Product Life Cycle (PLC)
- Degree of Standardization
- Designing for Mass Customization
- Delayed differentiation
- Modular design
- Reliability
- Robust Design
- Quality Function Deployment
- Computer-Aided Design (CAD)

**Product Life Cycle (PLC):** Products go through a sequence of stages during their useful lives, which are depicted in Figure 3.1. Demand is often the phase-dependent. In such a situation, different tactics are required for different phases. For successful business organizations, demand and cash flow estimates are critical inputs for strategy at every stage for a particular product.

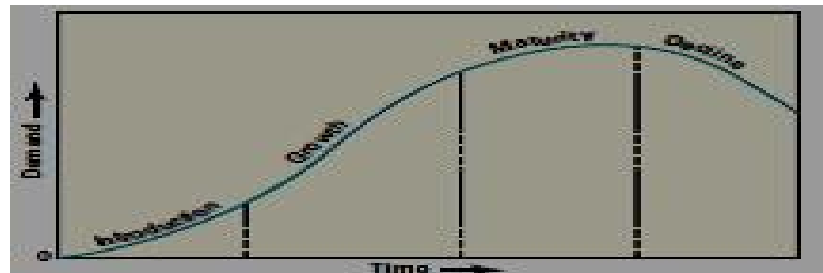

Figure 3.1: Product Life Stages

When a product is first released, it may be considered a novelty item. Many potential consumers may believe that all of the bugs have yet to be ironed out and that the price will reduce after the introductory period. Companies must carefully consider the trade-offs between getting all the bugs out and having a head start on the competition, as well as getting to market at a favorable moment. Introducing new high-tech products or features are examples during festive shopping seasons, which is especially desirable. It is critical to have a good projection of the beginning order to ensure appropriate product supply or service capacity. Design advancements and rising demand result in improved reliability and reduced costs over time, driving demand growth. During the expansion phase, it's critical to get accurate estimates of demand growth rates and how long they'll last, as well as to make sure that capacity increases keep pace with rising demand. The product or service reaches maturity in the next phase, and demand levels off. Only minor design changes are required. Costs are generally low, and production is high. It's critical to have a precise estimate of how long this phase will remain until the market becomes saturated and the decline phase begins.

---

**Unit 03: Product Design and Plant Layout**

---

During the decline phase, companies must decide whether to withdraw a product or service and replace it with a new one, quit the market, or try to find new uses or users for the existing product or service. Duct tape and baking soda, for example, have been used well beyond their initial use of taping heating and cooling ducts and cooking. Keeping existing products or services might have a lot of benefits. Using much of the same equipment, the same supply chain, and maybe the same distribution channels, the same person can create the product or offer the service. As a result, expenditures are often modest, and additional resource and training requirements are minimal. Wooden pencils, paper clips, nails, knives, forks, add-ons, drinking glasses, and similar things do not have life cycles. Most new items, though, do.

In the of services, some service life cycles are linked to product life cycles. For example, as older items are phased out, services like installation and repair are phased out as well. The amount of time it takes a product or service to go through each step of its life cycle varies greatly: some go through each stage in a relatively short time, while others take much longer. Frequently, it is a question of the item's basic necessity and phthalates which technology evolves. Some toys, novelty things, and fashion items have a one-year life cycle, whilst other, more practical items, such as laundry washers and dryers, can persist for years before succumbing to technological progress.

**Degree of Standardization:** The degree of uniformity is a significant consideration in both product/service and process design. The absence of variation in a product, service, or process is referred to as standardization. Calculators, computers, and 2 percent milk are examples of standardized products created in massive quantities of similar objects. Every customer or item processed receives virtually the same service when it is standardized. An automatic vehicle wash is a good example; each automobile receives the same attention, regardless of how clean or dirty it is. Standardized processes generate standardized items or give standardized services. Standardization has a lot of significant advantages as well as some drawbacks. Customers get easy access to standardized items. Standardized products include interchangeable parts, which reduce production costs while increasing productivity and making replacement and repair relatively simple when compared to bespoke parts. The costs of design are often cheaper. Automobile manufacturers, for example, standardize important components across product lines; brakes, electrical systems, and other "under-the-hood" equipment would be the same for all car models. Companies save time and money by decreasing variation while improving product quality and reliability.

As far as disadvantages are concerned, one of the most significant is the decrease in variety. This can limit the number of people who are interested in a product or service. As a result, there's a chance that a competitor will come out with a better product or more variety and gain a competitive advantage. Another problem is that a manufacturer may prematurely freeze (standardized design) and then find compelling reasons to reject alteration once the design has been frozen. When making decisions, designers must consider crucial challenges relating to uniformity.

**Designing for Mass Customization:** Standardization appeals to businesses because it allows them to produce large quantities of relatively low-cost products with limited diversity. Customers, on the other hand, usually desire more variety, despite the low price. Producers must figure out how to fix these challenges without sacrificing (1) the benefits of uniformity and (2) incurring a slew of additional costs of issues that are frequently associated with variety. These include increasing the resources required to achieve design variety; increasing variety in the manufacturing process, which would increase the number of skills required to produce products, lowering productivity; adding to the inventory burden during and after production by having to carry replacement parts for the increased variety of parts; and increasing the difficulty of diagnosing and repairing product failures. Mass customization, a method of producing standardized goods or services while incorporating some degree of customization in the final product or service, is the answer, at least for some organizations. This is made possible by several strategies. Delayed differentiation and modular design are two examples.

**Delayed differentiation:** Delayed differentiation is a delay strategy that involves manufacturing a product or service but not finishing it until consumer preferences or specifications are established. There are several variations on this theme. In the case of goods, almost-completed items may be held in inventory until customer orders are received, at which point customized features are added as requested. Furniture manufacturers, for example, can construct dining room sets but not apply stains, giving clients a choice of stains. Once a decision has been made, the stain can be applied quickly, reducing long lines for clients and giving the seller a competitive advantage.

**Modular Design:** Standardization is achieved through modular design. Modules are subassemblies made up of component pieces that have been grouped to the point that the constituent elements have lost their distinct identities. Computers are a good example of modular design since they include modular pieces that can be replaced if they break. Different computing capabilities can be obtained by assembling modules in various configurations. For mass customization, modular design allows manufacturers to swiftly build items with modules to create a personalized configuration for a single consumer, minimizing the considerable wait time that would otherwise occur if individual pieces had to be constructed.

**Reliability:** A product's, a part's, a service's, or an entire system's reliability is a measure of its ability to execute its intended function given a set of conditions. The importance of reliability is highlighted by the fact that prospective buyers use it to compare alternatives and sellers use it as a price factor. Reliability can affect repeat purchases, reflect on the image of the product, and, if it is too low, generate legal concerns. The higher a product's dependability, the fewer resources will be required to maintain it, and the less frequently it will be involved in the three Rs.

A circumstance in which an item does not perform as intended is referred to as failure. This includes not only situations when the item fails to work at all, but also cases where its performance is subpar or it performs in an unintended manner.



**Example:** A smoke detector, for example, may fail to respond to the presence of smoke (not work at all), sound an alarm that is too feeble to provide an effective warning (substandard performance), or sound an alarm even when there is no smoke present (unintended response).

Reliabilities are always described in terms of a set of circumstances known as normal operating conditions. Load, temperature, and humidity ranges, as well as operating procedures and maintenance plans, are all examples. Users who ignore these warnings are more likely to have parts or entire systems fail prematurely. Using a passenger car to tow heavy loads, for example, will cause excessive wear and tear on the drive train; driving over potholes or curbs frequently results in premature tire failure, and using a calculator to drive nails may have a significant impact on its ability to perform mathematical operations.

**Reliability Improvement:** Because total system reliability is a consequence of individual component reliability, increasing component reliability can enhance overall system dependability. Inadequate production or assembly techniques, unfortunately, can nullify even the best of designs, and this is a common cause of failures. The inclusion of backup components can improve system reliability. Upgrading user education and refining maintenance suggestions or processes can typically reduce failures in actual use. Finally, by simplifying the system (thus lowering the number of components that could fail) or changing component interactions (e.g., boosting the reliability of interfaces), it may be able to improve overall system reliability. Usually, popular ways adopted to unreliability of the product design are as follows:

1. Enhance the component design.
2. Improve assembly and/or production procedures.
3. Enhance testing.
4. Always have backups.
5. Enhance preventive maintenance practices.
6. Increase user awareness.

7. Enhance the system's design.

**Robust Design:** Some products or services will only work as intended in a limited set of circumstances, whilst others will work as intended in a much broader set. The latter is designed to be durable. Consider a pair of high-end leather boots that aren't designed for dirt or snow. Consider a pair of thick rubber boots for dirt and snow. Rubber boots are tougher than beautiful leather boots. The less likely a product or service is to fail as the environment in which it is used or performed changes. As a result, the more robustness that designers can integrate into a product or service, the better. As a result, the more robustness designers can integrate into a product or service, the better it will stand up, resulting in higher customer satisfaction. In terms of the manufacturing process, a similar case may be made for robust design. Environmental issues might hurt product or service quality. A negative consequence is less likely the more resistant a design is to certain factors.



**Examples:** Food, ceramics, steel, petroleum goods, and medicinal products, for example, all go through a heating process. Furnaces do not always heat evenly; heat might vary by position in an oven or throughout a production run. One solution could be to construct a better oven; another could be to design a system that moves the product during the heating process to achieve consistency. A robust-design strategy would result in a product that is unaffected by slight temperature changes during manufacturing.

**Quality Function Deployment:** It is critical to obtain feedback from clients to ensure that they will want what is being sold. Although getting client feedback can be done informally through conversations with them, there is a formal technique to capture their desires. Quality function deployment (QFD) is a method for incorporating the "voice of the customer" into both product and service development. The goal is to make sure that customer needs are considered at every step of the process. The primary aspect of QFD is listening to and comprehending the consumer. Requirements are frequently stated in broad terms, such as "It should be simple to alter the cutting height of the lawnmower." Once the requirements have been identified, they must be translated into technical words that are relevant to the product or service. A remark regarding altering the height of the lawnmower, for example, could refer to the mechanism, its location, directions for operation, the tension of the spring that regulates the mechanism, or the materials required. These must be related to the materials, dimensions, and processing equipment utilized for manufacturing purposes.

**Computer-Aided Design (CAD):** Product design is increasingly being done on computers. For product design, computer graphics are used in computer-aided design (CAD). Using a light pen, a keyboard, a joystick, or another similar device, the designer can edit an existing design or create a new one on a monitor. The designer can manipulate the design on the screen once it has been entered into the computer: It may be rotated to provide the designer with alternative angles, broken apart to give the designer a look inside, and a portion of it can be magnified for a closer look. The designer can print a copy of the finished design and store it electronically, making it available to anyone in the company who needs it (e.g., marketing, operations).



**Notes :**

- Many firms use simultaneous development, or concurrent engineering, to ensure a smoother transition from product design to production and to reduce product development time.
- Concurrent engineering, in its most basic form, entails bringing design and manufacturing engineers together early in the design phase to develop the product and its manufacturing processes at the same time.



- This notion has lately been broadened to include production personnel (for example, materials specialists) as well as marketing and purchasing personnel in loosely connected, cross-functional teams.
- In addition, suppliers' and customers' opinions are routinely requested.
- Of course, the goal is to create product designs that represent both client desires and manufacturing capabilities.
- Manufacturing employees can recognize production capabilities and capacity.
- They frequently have some design freedom in terms of selecting appropriate materials and methods.
- The ability to understand manufacturing capacities can aid in the selection process.
- Furthermore, design can have a significant impact on cost and quality issues, as well as reduce production conflicts.

### **3.5 Service Design**

Product and service design share a lot of commonalities. However, due to the nature of services, there are some significant variances. Unlike manufacturing, where production and delivery are typically separated in time, services are typically developed and supplied concurrently.

An act, something done to or for a customer is referred to as service (client, patient, etc.). It is delivered by a service delivery system, which contains the necessary buildings, processes, and talents. Many services are part of a product bundle, which is a collection of goods and services offered to a consumer. The importance of service in products is growing. A crucial competitive differentiation is the capacity to establish and execute dependable customer-oriented service. Successful companies integrate customer service with their products.

The complete service bundle is developed or refined through system design and it includes the following things :

1. The required physical resources.
2. The accompanying goods that the customer purchases or consumes, or that are provided as part of the service.
3. Explicit services (a service's core/essential functionality, such as tax preparation).
4. Implicit services (additional/additional characteristics such as friendliness and kindness).

The decision of a service strategy, which specifies the nature and focus of the service as well as the target market, is the first step in service design. This necessitates a top-level assessment of a service's prospective market and profitability (or need, in the case of a nonprofit organization), as well as an assessment of the organization's ability to supply it. Once the service's focus and target market have been identified, the target market's customer requirements and expectations must be determined.

The degree of variety in-service requirements, as well as the degree of client contact and involvement in the delivery system, are two significant challenges in service design. These factors influence whether services can be standardized or must be personalized. The more uniform the service, the less customer contact, and service requirement diversity there is. Product design is extremely similar to service design when there is minimal touch and little or no processing variability. High variability and client contact, on the other hand, indicate that the service must be highly tailored. The possibility of selling is a related factor in service design: The more client touch you have, the more sales possibilities you'll have.

Understanding the customer experience and focusing on how to keep control over service delivery to ensure customer satisfaction is required for design objectives based on the consumer perspective. To identify linkages between service delivery and perceived quality, the customer-

---

### Unit 03: Product Design and Plant Layout

---

oriented approach entails determining consumer demands and needs. This allows designers to make informed decisions when creating the delivery system. However, while depersonalizing service delivery for the sake of speed can hurt perceived quality, clients may not want or are willing to pay for highly individualized care, so trade-offs may be necessary.

**Service Blueprinting:** The service blueprint, which is a strategy for modeling and analyzing a service process, is a useful tool for conceiving a service delivery system. A service blueprint is similar to an architectural drawing, except that instead of illustrating building measurements and other construction elements, it depicts the essential customer and service operations that occur during a service operation.

The customer activities are at the top of the picture, and the relevant actions of the direct contact service workers are slightly below.

The "backstage contacts"—in this case, the culinary staff—come next, followed by the support, or "backroom," activities. The reservation system, food and supply orders, cashier, and laundry service outsourcing are all examples of support operations.

The following are the primary steps in service blueprinting:

1. Determine the service's limits and the level of detail required.
2. Determine the sequence of customer and service encounters and actions. A flowchart can be helpful in this situation.
3. Determine time estimates for each process phase as well as time variability.
4. Develop a plan to prevent or limit probable failure spots, as well as a plan to respond to service problems.

**Features of a well-designed service system:** A well-designed service system has several qualities.

They can be used to create a service system as recommendations. These are some of them:

1. Adherence to the organization's mission.
2. User-friendly design.
3. Being able to withstand variety.
4. It is simple to maintain.
5. Cost-effectiveness
6. Providing obvious value to customers.
7. Having effective linkages between back-of-the-house and front-of-the-house operations (i.e., no customer contact) (i.e., direct contact with customers).

Customer service should be prioritized in front operations, while speed and efficiency should be prioritized in back operations.

### **3.6 Types of Production System**

The part of an organization that creates products is called the production system. It is the activity of combining and transforming resources moving inside a defined system in a regulated manner to generate value by management's policies. A simplified manufacturing setup is demonstrated. The following are the characteristics of the production system:

1. Because production is a planned activity, each production system must have a goal.
2. The system converts different inputs into useful outputs.

3. It is not separate from the rest of the organization's systems. As shown in Figure 3.2, Job Shop, Batch, Mass, and Continuous Production Systems are the four types of the production system

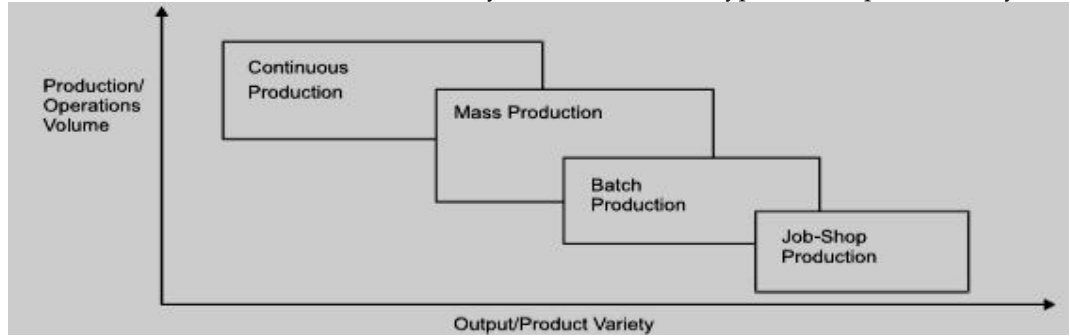

Figure 3.2: Types of Production Systems

#### **Job Shop Production:**

Job shop production is defined as the production of a single or small number of products developed and manufactured to the specifications of clients within a predetermined time and cost. This is distinguished by its modest volume and wide range of products. A job shop is a collection of general-purpose machinery organized into departments. Each work has its own set of technological needs and must be processed on machines in a specific order.

#### **Attributes of Job Shop Production System**

1. When there is a high diversity of products and low volume, the job-shop production system is used.
2. General-purpose machines and facilities are used.
3. Highly skilled operators who can approach each work as a new challenge due to its uniqueness.
4. A large supply of materials, tools, and spare components.
5. For sequencing the requirements of each product, capacity for each work center, and order priorities, detailed planning is required.

#### **Advantages of Job Shop Production System**

The following are some of the benefits of Jobshop production:

1. A wide range of items can be produced using general-purpose machines and facilities.
2. Operators will grow more proficient and competent since each work provides opportunities for them to learn.
3. Operators' full potential can be realized.
4. There is room for unique ideas and inventive solutions.

#### **Limitations of Job Shop Production System**

The restrictions of workshop production are as follows:

1. The expense of frequent setup adjustments is higher.
2. Higher inventory levels at all levels, resulting in higher inventory costs.
3. Production scheduling is difficult.
4. More space is required.

**Batch Production**

"A method of manufacturing in which the job moves through the functional departments in lots or batches, and each lot may have a different routing," according to the American Production and Inventory Control Society (APICS).

It is defined by the production of a small number of products at regular intervals and storage in anticipation of sales.

***Attributes of Batch Production***

When the following conditions apply, the batch manufacturing system is used:

1. When production runs are shorter.
2. When equipment and plant are adaptable.
3. When a plant and machinery setup is employed to produce a batch of items and a change of setup is necessary to process the next batch.
4. When the manufacturing lead time and cost are lower than the job lead time and cost

**Benefits of Batch Production**

Batch production has the following advantages:

1. More efficient use of plant and machinery.
2. Encourages the development of functional specialization.
3. When compared to work order production, the cost per unit is cheaper.
4. Lower capital expenditures on equipment and machinery.
5. The ability to handle and process a large number of products.
6. Operators are satisfied with their jobs.

***Limitations of Batch Production***

Batch production has the following limitations:

1. Because of the uneven and lengthier flows, material handling is complicated.
2. Production planning and control are difficult to manage.

**Mass Production :**

Mass production refers to the continuous manufacture of discrete pieces or assemblies. The high volume of production justifies this production strategy. A line or product arrangement is used to organize the machines. Standardization of products and processes exists, and all outputs follow the same path.

***Attributes of Mass Production :***

The following situations call for mass production:

1. Product and process sequence standardization.
2. Especially designed machinery with larger production capabilities and output rates.
3. A large number of products
4. Production cycle time is reduced.
5. Inventory in the process is reduced.

6. well-balanced Production lines.
7. Materials, components, and parts flow continuously and without interruption.
8. Planning and controlling production is simple

### **Advantages of Mass Production**

The following are some of the benefits of mass production:

1. Faster manufacturing rate with shorter cycle times.
2. Line balancing results in higher capacity utilization.
3. Operators with fewer skills are required.
4. Process inventory is low.
5. The cost of production per unit is minimal.

### **Limitations of Mass Production**

The restrictions of mass production are as follows:

1. A single machine failure will shut down an entire production line.
2. Product design modifications necessitate considerable adjustments to the inline layout.
3. Significant investment in manufacturing facilities.
4. The slowest process determines the cycle time.

### **Continuous Production**

From the beginning operations to the finished product, production facilities are organized according to the sequence of operations. Material handling equipment such as conveyors and transfer devices are used to make things flow through the sequence of operations. Continuous production is employed in the following situations:

1. Fixed plant and equipment with no room for error
2. The material handling process is completely automated.
3. The process follows a predetermined operating sequence.
4. Component materials are difficult to distinguish from the finished product.
5. Scheduling and planning are normal tasks.

### **Advantages of Continuous Production**

The benefits of continuous production are as follows:

1. Product and process sequence standardization.
2. Faster manufacturing rate with shorter cycle times.
3. Line balancing results in higher capacity utilization.
4. Material handling does not require human intervention because it is fully automated.
5. People with low skills can work on the assembly line.
6. Because of the great volume of production, the unit cost is cheaper.

### **Limitations of Continuous Production**

Continuous production has the following limitations:

1. There is no flexibility to adapt and process a large number of products.
2. The cost of installing flow lines is extremely high.
3. There is little product differentiation.

### **3.7 Plant Layout**

The physical arrangement of industrial facilities is referred to as plant layout. In the conversion process, it is the configuration of departments, work centers, and equipment. It is a floor layout of the physical facilities that are employed in the manufacturing process.

"Plant layout" is defined by Moore as "a plan for the optimal arrangement of facilities, including employees, operational equipment, storage space, material handling equipment, and all other supporting services, as well as the design of the best building to accommodate all of these facilities."

#### **Objectives of Plant Layout**

The fundamental purpose of the plant layout is to maximize profit by arranging all of the plant facilities to best benefit overall product manufacture.

The following are the goals of plant layout:

1. Make the material flow through the plant more efficient.
2. Make the production process easier.
3. Maintain high in-process inventory turnover.
4. Cut down on material handling and costs.
5. Effective use of personnel, equipment, and space.
6. Make the most of the available cubic space.
7. Manufacturing operations and arrangements are flexible.
8. Provide convenience, safety, and comfort for employees.
9. Minimize equipment purchases.
10. Reduce total production time.
11. Keep the arrangement and functioning flexible.
12. Make the organizational structure easier.

#### **Types of Layouts**

Layouts can be classified into the following five categories:

1. Process layout
2. Product layout
3. Combination layout
4. Fixed position layout
5. Group layout

**Process layout:** All machines that execute similar types of processes are put together in one area in the process plan, such as all lathes, milling machines, and other machines in the shop. For batch production, a process layout is recommended. As a result, in process layout, facilities are grouped

together based on their functions. The figure depicts a typical process layout. Material flow patterns through the facilities from one functional area to the next differ by product. The paths are usually long, and there is the option of backtracking. When the production volume is insufficient to support a product layout, a process layout is usually used.

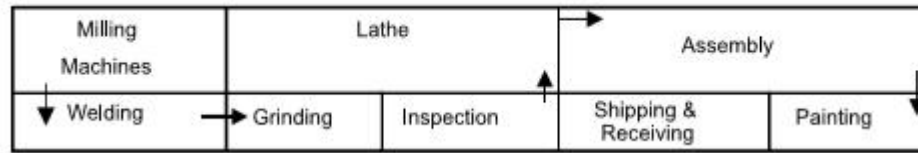

Figure 3.3 Process Layout

#### Advantages

1. In-process layout machines are more efficient, requiring fewer machines.
2. Process structure allows for equipment and people flexibility.
3. Lower investment due to the lesser cost of general-purpose machines and the lower number of machines.
4. Increased production facility utilization.
5. A great degree of flexibility in the distribution of labor among machines and workers.
6. The job is tough and intriguing because of the variety of responsibilities and job variety.
7. Supervisors will gain a deep understanding of the functions inside their department.

#### Limitations

1. In the handling of materials, backtracking and extended moves may occur, lowering material handling efficiency.
2. Material handling cannot be automated, increasing costs.
3. Process time is extended, resulting in lower inventory turnover and higher in-process inventory.
4. Productivity has suffered as a result of the increased number of set-ups.
5. The period between in and out of the process (throughput) is longer. Work-in-progress consumes both space and capital.

**Product Layout:** Machines and auxiliary services are placed according to the product's processing sequence in this layout. If a significant volume of one or more goods is produced, the facilities can be set up to ensure a smooth flow of materials and a cheaper cost per unit. Special purpose machinery is employed to complete the task swiftly and accurately. When the volume of production of a product is high enough, a separate production line to make it may be justified, and the product layout is chosen. Machines are not shared by multiple items in a rigorous product arrangement. As a result, the output volume must be sufficient to achieve satisfactory equipment utilization. Figure 3.4 depicts a typical product layout.

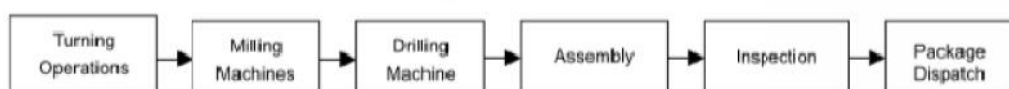

Figure 3.4: Product Layout

#### Advantages

### Unit 03: Product Design and Plant Layout

1. In flow lines, product flow will be smooth and rational.
2. There is less in-process inventory.
3. There is a reduction in throughput time.
4. The expense of material handling is kept to a bare minimum.
5. It is feasible to simplify production, planning, and control systems.

#### Disadvantages

1. A failure of one machine in a product line can force the line's downstream equipment to stop working.
2. A change in product design may necessitate significant layout changes.
3. The bottleneck machine determines the line output.
4. A significant capital investment in equipment is necessary.
5. A lack of adaptability. A change in the product may need a facility change.

**Combination layout:** The advantages of both types of layouts are combined in a process and product layout. When an item is manufactured in multiple types and sizes, a combination arrangement is available. The machinery is grouped in a process arrangement, but the process grouping is then ordered in a sequence to make a variety of goods of different sorts and sizes. It's worth noting that the sequence of processes is consistent over a wide range of items and sizes. Figure 3.5 depicts a combination type of configuration for producing various gear sizes.

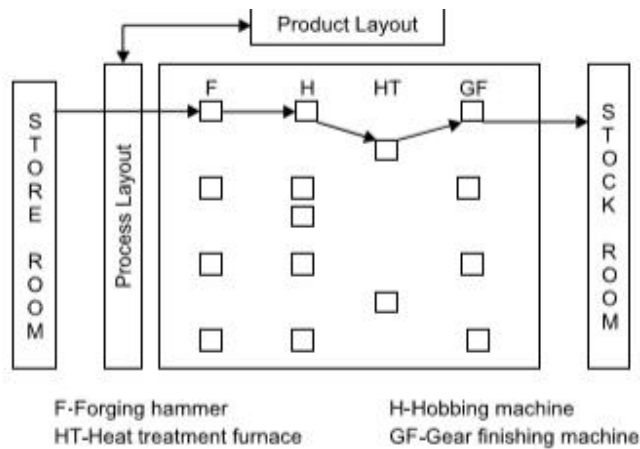

Figure 3.6: Combination Layout

**Fixed Position Layout:** This is also known as the project layout. The material, or major components, remain in a fixed location in this form of layout, while tools, machines, men, and other materials are brought to this area. When one or a few pieces of identical heavy items are to be created, and the assembly consists of a large number of heavy parts, the cost of transportation of these parts is very high, this sort of arrangement is appropriate.



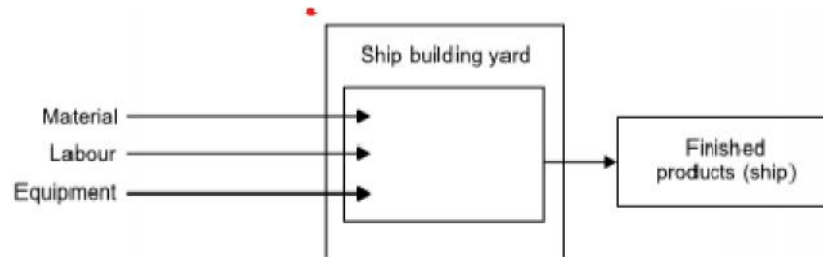

Figure 3.7: Fixed Position Layout

**Group Layout (or Cellular Layout):** The analysis and comparison of things to group them into families with comparable features are known as group technology (GT). GT can be used to create a hybrid plan that combines pure process and pure flow line (product) layouts. This technique is highly useful for organizations that produce a range of parts in small quantities and want to take advantage of the flow line layout's advantages and economics.

As a result, group layout is a hybrid of product and process layouts. It combines the benefits of both layout techniques in one package. If there are  $m$ -machines and  $n$ -components,  $m$ -machines and  $n$ -components will be separated into a distinct number of machine-component cells (group) in a group layout (Group-Technology Layout), such that all the components allocated to a cell are almost processed within that cell itself. The goal here is to keep intercell motions to a minimum. The primary goal of a group technology layout is to find families of components that have comparable criteria for meeting all of the machine's requirements. These components are then grouped into cells. Each cell is capable of meeting all of the requirements of the component family to which it has been assigned.

In a technology layout for a group, the goal is to reduce the total cost of transportation and equipment. As a result, this is referred to as a multi-objective layout. Figure 3.8 depicts a typical Group layout.

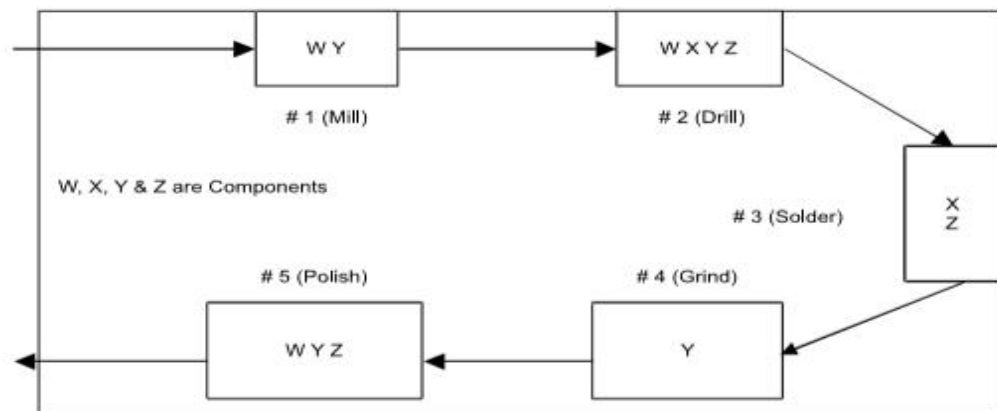

Figure 3.8: Group Layout (or Cellular Layout)

### 3.8 Products and Services Profiling

Process selection might necessitate a significant investment in equipment and have a significant impact on the layout of facilities, which also necessitates a significant investment. Mismatches between operational skills and market demand, as well as pricing or cost strategies, can have a substantial detrimental influence on an organization's capacity to compete or, in the case of government agencies, efficiently serve customers. As a result, in order to establish an adequate match, it is highly important to examine the degree of correlation between various process choices and market conditions before making process choices. By identifying essential product or service

### Unit 03: Product Design and Plant Layout

dimensions and then selecting appropriate methods, product or service profiling can be utilized to eliminate inconsistencies. The range of products or services that will be processed, projected order amounts, pricing strategies, estimated frequency of schedule adjustments, and order-winning requirements are all important elements to consider.

Business companies are under increasing demand to operate sustainable production processes from a range of sources. "Sustainable Production is the creation of goods and services using processes and systems that are: non-polluting; conserving energy and natural resources; economically efficient; safe and healthful for workers, communities, and consumers; and socially and creatively rewarding for all working people," according to the Lowell Center for Sustainable Production (<http://sustainableproduction.org>). To do so, the Lowell Center recommends that processes be designed and operated in such a way that: "wastes and ecologically incompatible byproducts are reduced, eliminated, or recycled on-site; chemical substances or physical agents, as well as conditions that are hazardous to human health or the environment, are eliminated. Energy use and efficiency, CO<sub>2</sub> (carbon footprint) and hazardous emissions, waste generation, lighting, heating, cooling, ventilation, noise and vibration, and worker health and safety are all variables that must be considered in order to achieve these objectives. Various strategic Initiatives that can be used for this are the adoption of the latest technology, lean process design, and Automation.

When it comes to process design, one of the most important considerations is whether or not to automate. Automation refers to machinery that has sensors and controls that allow it to run on its own. If a business agrees to automate, the next question is how much will it automate. Automation can be anything from fully automated factories to a single automated function. Customized services are also available. Automated services are growing increasingly significant, despite their scarcity in comparison to manufacturing. Automated inspection, automated storage and retrieval systems, package sorting, mail processing, e-mail, online banking, and E-Z pass are examples that vary from automated teller machines (ATMs) to automated heating and air conditioning.

### 3.9 Line Balancing

The layout is frequently impacted by assembly-line balancing. This might happen if the size or number of workstations needed to be physically changed for balance reasons. The most common assembly line consists of a moving conveyor that goes through a sequence of workstations in a consistent time interval known as the workstation cycle time (which is also the time between successive units coming off the end of the line). Work on a product is done at each workstation, either by adding parts or finishing assembly activities. Each station's job is broken down into tasks, elements, and work units, which are all grouped together. The motion-time analysis is used to characterize such jobs. They're usually groups that can't be subdivided on the assembly line without incurring a cost in extra motions. The technique of allocating tasks to workstations in such a way that they need roughly equal amounts of time. Is termed as Line Balancing

The sum of the tasks assigned to a workstation equals the entire work to be done at that workstation. The line-balancing problem entails assigning all tasks to a set of workstations in such a way that each workstation has no more work than it can complete in the workstation cycle time, and the unassigned (idle) time across all workstations is kept to a minimum. The link between tasks imposed by product design and process technologies further complicates the challenge. This is known as the precedence relationship, and it dictates the order in which jobs in the assembly process must be completed.

#### Line Balancing Numerical

Task	Immediate Predecessor	Task Time(minutes)
A	--	0.9
B	A	0.4
C	B	0.6
D	C	0.2

Operations Management and Research

E	C	0.3
F	D,E	0.4
G	F	0.7
H	G	1.1

Use the information in the table above :

- 1) Draw a precedence diagram.
- 2) Assuming that 55 minutes per hour are productive, compute the cycle time needed to obtain 50 units per hour.
- 3) Determine the number of workstations.
- 4) Assign tasks to workstations using the longest time heuristic.
- 5) Calculate the utilization.

Solution

- 1) Precedence diagram

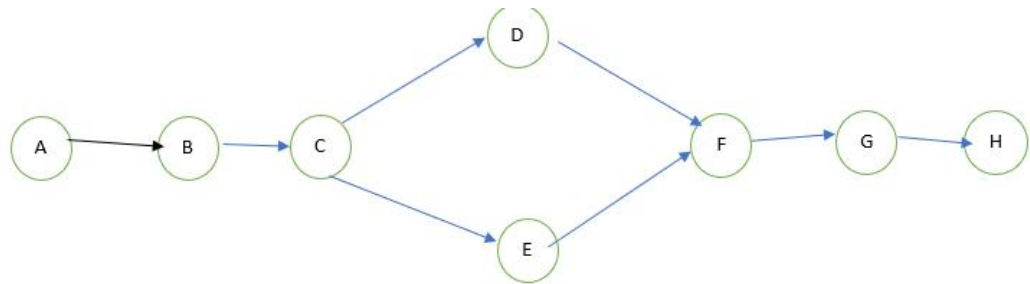

- 2) Assuming that 55 minutes per hour are productive, compute the cycle time needed to obtain 50 units per hour.

$$\text{Cycle time} = \frac{\text{Operating time}}{\text{Desired output}}$$

$$\text{Cycle time} = \frac{55 \text{ minutes per hour}}{50 \text{ products per hour}} = 1.1 \text{ minutes per product}$$

- 3) Determine the number of workstations.

$$N_{\min} = \frac{\Sigma t}{\text{Cycle time}}$$

where

$N_{\min}$  = Theoretical minimum number of stations

$\Sigma t$  = Sum of task times

Unit 03: Product Design and Plant Layout

Number of workstations= (4.6 minutes per product\* 50 products per hour)/ 55 minutes per hour  
 = 4.2 workstations= 5 approx.

4) Assign tasks to workstations using the longest time heuristic.

Station	Time Remaining	Eligible	Will Fit	Assign(task time)	Remaining time	Idle Time
1	1.1	A	A	0.9	0.2	0.2
2	1.1	B	B	0.4	0.7	
	0.7	C	C	0.6	0.1	0.1
3	1.1	D,E	E	0.3	0.8	
	0.8	D	D	0.2	0.6	
	0.6	F	F	0.4	0.2	0.2
4	1.1	G	G	0.7	0.4	0.4
5	1.1	H	H	1.1	0	

Total Idle 0.9  
Time

Summarize the assignment of tasks to workstations on the production line

Tasks in Workstations	Workstations
A	1
B,C	2
E,D,F	3
G	4
H	5

5) Calculate the utilization.

Utilization = (Minimum Number of Workstations/Actual Number of workstations)\*100  
 =(4.2/5)\*100  
 = 84%

### 3.10 Designing the Layouts

#### Designing for Product Layout

Product layout involves dedicating equipment or departments to a certain product line, using duplicate equipment to avoid backtracking, and achieving a straight-line material flow. When the batch size of a given product or part is large in comparison to the number of different goods or parts produced, using a product layout makes sense. Assembly lines are a type of product arrangement that is unique. In a broad sense, the word "assembly line" refers to a series of interconnected assembly stations connected by some sort of material-handling technology. The common assumption is that there is some type of pacing in place and that the maximum processing time for all workstations is the same. There are significant variances across line kinds within this wide term. Material handling devices (belt or roller conveyor, overhead crane), line configuration (U-shape, straight, branching), pacing (mechanical, human), product mix (one or multiple products), workstation characteristics (workers may sit, stand, walk with the line, or ride the line), and line length are just a few of them (few or many workers).

Toys, appliances, automobiles, apparel, and a wide range of electronic components are among the products partially or wholly assembled on lines. In fact, assembly lines are used in some form or another in almost every product that contains several pieces and is mass-produced in big

quantities. The determination of the optimal arrangement of operators and buffers in a production flow process is a more difficult challenge. The assignment of operations so that all stages are more or less evenly loaded is a fundamental design factor in production lines. Take, for example, the classic assembly lines depicted in Figure 3.9

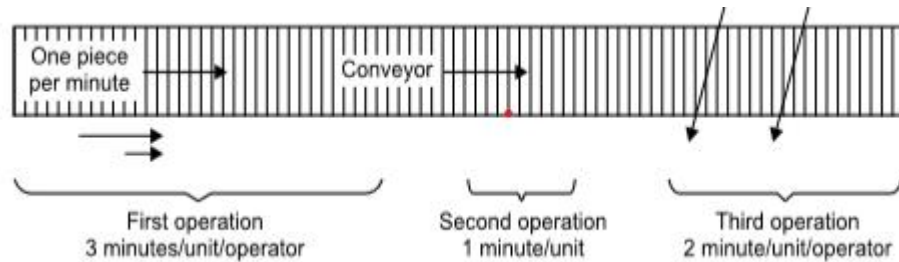

Figure 3.9 Traditional Assemble Lines

Parts flow at a pace of one per minute along a conveyor to three groups of workstations in this scenario. The first process takes three minutes for each unit, the second takes one minute, and the third takes two minutes per unit. Three operators work at the first workstation, one operator at the second, and two operators at the third. At his or her workstation, an operator puapartpart from the conveyor conducts some sort of assembly operation. The completed portion is placed back on the conveyor and moved on to the next step. The number of operators at each workstation was determined in order to balance the line.minute.This holds true for the other two stations as well.Parts are completed at the same rate as they arrive, which is one per minute.When the time required to complete individual subassemblies varies little, assembly-line systems operate well.Operators further down the line may not be able to keep up with the flow of parts from the preceding workstation or may face excessive idle time if the jobs are fairly difficult, resulting in a higher assembly-time variance.A series of workstations linked by gravity conveyors that act as buffers between succeeding processes is an alternative to a conveyor-paced assembly line.

**Designing for Process Layout:** The timing, synchronization, and balance of separate steps in the process are all factors to consider when designing production lines and assembly lines.

Because of the significant amount of transit and handling required, the relative organization of departments and machines is the most important issue in process design.

#### Steps required for designing process Layout::

The best relative positions of functional work centers are determined by process layout design. Work centers that interact regularly, such as with material or people movement, should be close together, and those that contact infrequently can be separated spatially.

The following is a description of one method/Steps for creating a functional layout that is both efficient and effective.

1. Make a list of each functional work center and describe it.
2. Get a drawing and a description of the facility you're working on.
3. Determine the volume of material and manpower flow between work centers and estimate it.
4. To get a decent general layout, use structured analytical methods.
5. Evaluate and adjust the plan, taking into account factors like machine orientation, storage space location, and access to equipment.

Identifying and describing each work center is the initial stage in the layout process. The principal function of the work centers, such as drilling, new accounts, or cashier; its major components, such as equipment and employees; and the area necessary should all be included in the description. Any specific access requirements (such as access to running water or an elevator) or limits should be included in the description (it must be in a clean area or away from heat). The size and shape of a

### Unit 03: Product Design and Plant Layout

new facility, as well as the spatial organization of the work centers, are all determined at the same time. The layout phase includes determining the locations of particular structures and facilities such as elevators, loading docks, and bathrooms.

To save transportation times and material handling costs, we'd like to cluster the work centers that have the most material and personnel flow between them. It's a good idea to start by developing a relationship diagram like the one shown in Fig. 3.10 to estimate the flows between work centers. Material flows and transportation costs in manufacturing systems can be adequately approximated utilizing historical product routings or work sampling techniques applied to people or jobs. People flow can be difficult to estimate precisely, especially in a service system like a corporate office or a university administrative building, though work sampling can be utilized to get ballpark figures.

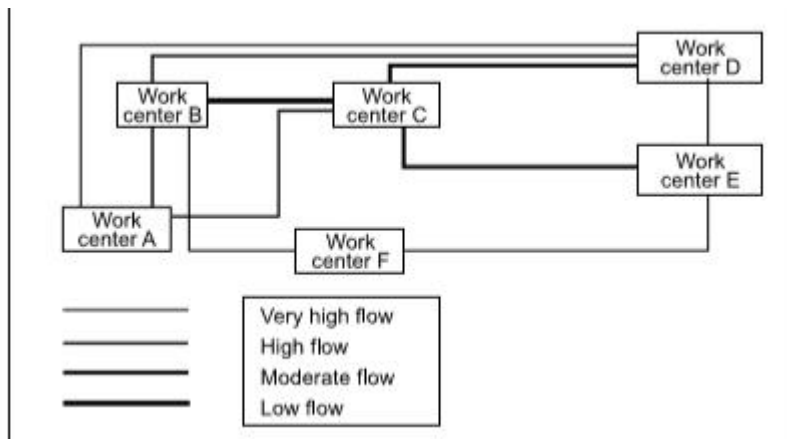

Figure 3.10: Flow Diagram for Relationship



#### Notes

- A product layout's purpose is to organize personnel or equipment in the order in which tasks must be completed.
- A manufacturing line or assembly line is the term used to describe the sequence.
- These lines range in length from short lines with a few operations to long lines with several operations.
- Long lines can be seen on assembly lines for automobiles.
- Line balancing refers to the process of selecting how to assign workloads to workstations.
- The purpose of line balancing is to achieve work groupings with roughly equal time needs.
- This cuts down on idle time on the line and maximizes personnel and equipment usage.
- Idle time happens when task times are not evenly distributed among workstations; some stations can produce at a faster rate than others.
- These "quick" stations will have to wait for the output from slower stations on a regular basis, or they will be compelled to idle to prevent work from piling up between stations.

#### Summary

- Organizations' process selection decisions frequently have strategic ramifications.
- Cost, quality, productivity, customer satisfaction, and competitive advantage are all factors to consider.
- Job shops, batch processing, repetitive processing, continuous processing, and projects are all examples of process types.

### Operations Management and Research

---

- The type of process dictates how work is organized and has ramifications throughout the organization and its supply chain.
- The layout and process type are inextricably linked.
- Layout decisions affect operating costs and efficiency and are a significant part of the design of operations systems.
- Process selection decisions are frequently linked to layout decisions.
- Product layouts are designed for high-volume, uniform item production.
- Workers and equipment are organized in the technological order required by the product or service in question.
- Workflow through the system is emphasized in the design, and specialized processing and handling equipment is frequently used.
- Breakdowns are very common in product layouts.
- Preventive maintenance is a technique for reducing the likelihood of failure.
- Similar activities are grouped together in departments or other work centers in a process layout.
- These systems are more resistant to breakdowns and can manage a wide range of processing needs.
- However, due to the wide range of processing needs, continuous routing, and scheduling, as well as the utilization of variablepath material-handling equipment, are required.
- Product layouts have a substantially higher output rate than product layouts.

### Keywords

**Concurrent design and manufacturing** refer to the process of completing the design and manufacturing stages of a product at the same time. Products are manufactured in less time and at a lesser cost by completing the design and manufacturing processes at the same time.

**Design for assembly:** The practice of designing items with ease of assembly in mind is known as design for assembly (DFA). When a product has fewer pieces, it takes less time to build, which lowers assembly costs.

A **service blueprint** is a diagram that depicts the full-service delivery process by detailing all of the activities that occur at each stage and are carried out by the various roles involved.

### SelfAssessment

1. Product and service designs depend on:
  - A. Quality expectations in the market
  - B. Maximum cost which can be incurred for a product
  - C. Desired competitive advantage
  - D. All of these
  
2. Which of the following demands a new service design?
  - A. Abrupt drop in demand
  - B. Reduced cost demanded from the customers
  - C. New relaxed safety norms from the Government
  - D. All of the above

3. Which phase of the product life cycle shows the highest growth rate?
- A. Introduction
  - B. Growth
  - C. Maturity
  - D. Decline
4. Which of the following are true?
- A. Car manufacturing is a mix of goods and services
  - B. Bike repair is a mix of goods and services
  - C. Stone mining is a mix of goods and services
  - D. All of the above
5. Which of the following are required in both products and services?
- A. Forecasting demand
  - B. Capacity planning
  - C. Location planning
  - D. All of the above
6. In the QFD diagram, the Relationship matrix shows the relation between:
- A. Design requirement & Customer requirement
  - B. Customer requirements & Target values
  - C. Design requirement & Target values
  - D. None of the above
7. Idea generation phase in product development involves:
- A. Customers
  - B. Top management
  - C. Competitors
  - D. All of the above
8. Feasibility analysis phase in product development involves analysis of:
- A. Market
  - B. Economic factors
  - C. Technical factors
  - D. All of the above
9. Which of the following are the components of service design?
- A. Explicit services
  - B. Implicit services
  - C. Physical resources



- D. All of the above
10. Which tool(s) can be used to conceptualize a service design?
- A. Scope identification
  - B. Detailed flowchart preparation
  - C. Analyzing profitability
  - D. All of the above
11. A process type in which highly customized jobs are received and a different set of skills might be required to handle each one of them.
- A. Job shop
  - B. Batch process
  - C. Repetitive process
  - D. Continuous process
12. A process type where the level of customization is an intermediate and complete set of activities are divided into the smaller set with the respective specialized workforce:
- A. Job shop
  - B. Batch process
  - C. Repetitive process
  - D. None of the above
13. A process where raw materials are fed in as input and output is received with the least human intervention:
- A. Job shop
  - B. Batch process
  - C. Repetitive process
  - D. Continuous process
14. What are the key dimensions of products& services?
- A. Expected order size
  - B. Pricing criteria
  - C. Expected variation
  - D. All of the above
15. Which of the following contributes to the lean process design?
- A. Waste reduction
  - B. Variance reduction
  - C. Inventory reduction
  - D. All of the above

## Answers for Self Assessment

- |       |       |       |       |       |
|-------|-------|-------|-------|-------|
| 1. D  | 2. D  | 3. B  | 4. D  | 5. D  |
| 6. A  | 7. D  | 8. D  | 9. D  | 10. D |
| 11. A | 12. B | 13. D | 14. D | 15. D |

## Review Questions

1. What are some of the elements that prompt businesses to reinvent their goods or services?
2. Distinguish between product design and service design.
3. What is Computer-Aided Design (CAD)? Describe some of the applications for a product designer.
4. Describe some of the major benefits and drawbacks of standardization.
5. What is a modular design, and how does it work?  
What are the primary benefits and drawbacks?
6. Define the term "manufacturing design" and explain why it is significant.
7. What are some of the advantages of concurrent engineering in terms of competitiveness?
8. Describe what the phrase "remanufacturing" means.
9. What does the term "life cycle" mean? Why would this be a factor to consider while designing a product or service?
10. Following their success with offering customers fresh salads, a number of fast-food companies began adding fresh fruit platters to their menus in an effort to distance themselves from the image of selling unhealthy food. Several other fast-food businesses began adding fat- and calorie-laden products to their menus around the same time, appearing in direct opposition to this "healthy" policy. Compare and contrast these two very different approaches, and forecast their chances of success. Name a few more goods that are widely used despite their acknowledged health hazards.



## Further Readings

1. Operations Management By Norman Gaither, Cengage Learning
2. Operations Management By Russell And Taylor, Wiley



## Web Links

1. Service Design- <https://www.interaction-design.org/literature/topics/service-design>
2. Service Design - Design is Not Just for Products-<https://www.interaction-design.org/literature/article/service-design-design-is-not-just-for-products>
3. Product and Service Profiling-  
<https://www.slideshare.net/MeenakshiSingh46/product-service-profiling>

## Unit 04: Plant Location Analysis

### CONTENTS

Objectives

Introduction

- 4.1 Need for Plant Location Analysis
- 4.2 Basic Procedural Mechanism for Plant Location Decisions
- 4.3 Strategic Options for Plant Manufacturing
- 4.4 Factors affecting Plant Location Analysis
- 4.5 Evaluation Methods for Plant Location Analysis

Summary

Keywords

Self Assessment

Answers for Self Assessment

Review Questions

Further Readings

### Objectives

After studying this unit, you will be able to:

- Understand the importance of Plant Location analysis for effective production related decisions of an organization.
- Get familiarity about the important factors that play significant role for selection of plant Location.
- Understand the models used for selection of plant Location.

### Introduction

Plant location related decision is one of the important and strategic areas for operations department of an manufacturing organization. A low-cost production strategy, for example, can entail situating where labor and material costs are cheap, or placing near customers or raw supplies to save on transportation expenses. A strategy that emphasizes customer convenience may result in having many locations where customers can transact business or make purchases (e.g., branch banks, ATMs, service stations, fast-food outlets), while a strategy that emphasizes profit by increasing market share may result in locating in high-traffic areas. Furthermore, the efficiency with which products (services) are transmitted to clients is one of the essential elements of a conversion process (manufacturing system). This will entail deciding where the factory or facility will be located. Because a considerable investment is made in establishing plant and machinery, choosing a location is a critical decision. Changing the venue frequently is not advisable or practicable. As a result, an incorrect plant placement may result in the loss of all of the expenditures made in the building, machinery, and equipment. Long-term predictions of the company's future demands should be made before a location for a factory is chosen. The location of the plant should be based on the company's expansion plan and policy, product diversification plan, changing market conditions, changing raw material sources, and many other aspects that influence the site decision. The goal of the location research is to identify the most advantageous location for the company.

#### 4.1 Need for Plant Location Analysis

For a variety of reasons, existing firms may need to make location selections. Banks, fast-food restaurants, supermarkets, and retail stores all consider location as part of their marketing strategy, and they seek out sites that can help them extend their markets. Essentially, in those circumstances, the location decisions reflect the addition of additional locations to an existing system. A situation comparable to this arises when a company's demand for its products or services grows to the point where expansion at an existing site is no longer feasible. Adding a new location to supplement an existing system is frequently a viable option.

Three conditions necessitate the selection of an appropriate Plant Location.

- When new manufacturing unit has to be established
- In situation where existing manufacturing organization interested for expansion
- In situation where organization is more inclined towards global market .

**When new manufacturing unit has to be established:** While cost savings are usually crucial when choosing a location for the first time, it's also necessary to consider the cost of long-term business/organizational goals.

**In a situation where existing manufacturing organization interested for expansion:** A manufacturing plant must fit into a multi-plant operations strategy in this situation. That is, under the following conditions, additional plant locations in the same premises and elsewhere:

1. A facility that produces a variety of goods.
2. A manufacturing plant that serves a certain market segment.
3. The plant is divided into sections based on the manufacturing process or stages.
4. Plants that emphasize adaptability.

**In situation where organization is more inclined towards global market:** Globalization has created new markets and increased the global dispersion of industrial and service operations. Furthermore, many businesses are outsourcing operations to organizations in other countries. In the past, businesses tended to operate from a single "home base" in a single country. Companies are now looking for strategic and tactical reasons to expand their business globally. Some companies are benefiting from their efforts, while others are struggling, and all must deal with the problems that come with managing worldwide operations. Globalization has become appealing and possible for commercial enterprises due to a number of causes. such as trade agreements and technology etc.



#### Notes

- Location selections are important; they can have a big impact on a company's success or failure.
- Because location decisions are frequently long-term and require significant financial investment, it is critical to commit sufficient time and effort to selecting a place..

#### 4.2 Basic Procedural Mechanism for Plant Location Decisions

The size of an organisation, as well as the nature or scope of its operations, influences how it makes location related decisions. When it comes to site considerations, new or tiny businesses tend to take a more casual approach. New businesses are frequently established in a specific location just because the proprietor resides there. Similarly, small-business owners frequently prefer to keep operations in their own backyard, so they tend to concentrate nearly entirely on local alternatives. Large, well-established businesses, particularly those with multiple locations, tend to take a more formal approach. Furthermore, they frequently take into account a broader range of geographical regions. The focus of this debate is on a formal approach to location considerations.

#### **Procedural steps for selection are as follows**

1. Determine the criteria for assessing alternate locations, such as improved revenue or community service and effective customer services .
2. Determine critical elements such as market location and raw material availability.
3. Create alternative locations:
  - a. Determine the location of a country or countries.
  - b. Determine the general area of a location.
  - c. Identify a few community-based alternatives.
  - d. Choose a site from among the community possibilities
4. Consider your options and make a decision.

### **4.3 Strategic Options for Plant Manufacturing**

Companies with several manufacturing plants might organize their operations in a variety of ways. One option is to assign several product lines to various factories. Another option is to assign different plants to different market areas. A third option is to assign certain processes to various plants. Each approach has its own set of financial and management costs, as well as competitive advantages. Various strategic option for establishment of manufacturing plant to the organizations are as follows :

- Product Plant Strategy.
- Market Area Plant Strategy
- Process Plant Strategy.
- General-Purpose Plant Strategy

Product plant strategy involves producing whole items or product lines in independent plants, with each plant often serving the entire domestic market. This is effectively a decentralized model, with each factory focused on a certain set of requirements involving people, resources, and equipment specialization along product lines. Further in case of market area plant strategy, Plants are created to cater to a certain geographic market niche (e.g., the West Coast, the Northeast). Individual plants manufacture the majority of the products, if not all, of a company's products and serve a small geographic area. Although operating expenses are often greater than those of product facilities, transportation costs for equivalent products can be significantly reduced. When shipping expenses are high owing to volume, weight, or other factors, this arrangement is very advantageous. Rapid delivery and sensitivity to local demands are also advantages of such agreements. Due to changing market conditions, this technique necessitates centralized coordination of decisions to add or delete plants, or to expand or reduce current operations. Additionally, in case of process plant strategy, different plants focus on different components of a process. This is a common strategy used by automakers, with separate factories for engines, transmissions, body stamping, and even radiators. This method is best suited to items with several components; splitting component production reduces confusion compared to if all production were done in the same location. When a company uses process plants, production coordination across the entire system becomes a key issue that necessitates a well-informed, centralized administration to ensure efficient operation. Finally production plants that follow general-purpose plant strategy are adaptable and capable of handling a widerange of products. This enables for quick reaction to product or market changes, but it is less productive than a more focused strategy.

### **4.4 Factors affecting Plant Location Analysis**

The process of determining a geographic location for a company's operations is known as facility location. When evaluating the suitability of a specific site, managers of both service and manufacturing businesses must consider a variety of considerations, including accessibility to customers and suppliers, labor expenses, and transportation costs. Location conditions are complicated, and each one has its own set of tangible (i.e. freight rates, production expenses) and intangible (i.e. reliability, frequency security, and quality) characteristics. It's difficult to assess the conditions at a given location. Wages and product costs, for example, may be defined carefully to determine what makes places better to compare. Non-tangible properties, such as reliability, availability, and security, on the other hand, can only be quantified on an ordinal or even nominal scale. Other intangible characteristics, such as the percentage of employees who are unionized, can also be quantified. To summarize, non-tangible characteristics play a significant role in business site selections. The elements that influence the plant or facility site based on the nature of the organization should be divided into two categories:

1. General locational factors, which encompass both controllable and uncontrollable aspects for all types of organizations.



**Examples for general location factors such as controllable as well as uncontrollable**

Factors category	Examples
Controllable	Proximity to markets , supply of materials , transportation facilities , infrastructure availability, Labor and wages, External economies, Capital
Uncontrollable factors	Government policy, climate conditions, supporting industries and services, Community and labor attitudes, Community Infrastructure

2. Specific locational criteria that manufacturing and service organizations demand.



**Examples for specific factors for manufacturing as well as service organizations**

Factors category	Examples
Dominant Factors(for manufacturing )	Favorable labor climate, Proximity to markets, Quality of life, Proximity to suppliers and resources, Utilities, taxes, and real estate costs
Secondary factors (for manufacturing )	Room for expansion, construction costs, accessibility to multiple modes of transportation, the cost of shuffling people and materials between plants, competition from other firms for the workforce, community attitudes, and many others
Dominant factors( for service organizations )	Proximity to customers, transportation costs and proximity to markets, location of competitors
Secondary factors( for service organizations )	Level of retail activity, residential density, traffic flow, and site Visibility.



**Notes :**

- The appeal of a few factors should not influence the decision-making process. When choosing a place, there are numerous aspects to consider. It's critical to identify the most important elements and their relative importance, and then utilise that information to compare other locations.
- It's also crucial to consider the influence of site decisions on the supply chain.

- The evaluation data of plant location suitability for numerous subjective criteria, as well as the weights of the criteria, are frequently expressed in linguistic words in real life.

#### 4.5 Evaluation Methods for Plant Location Analysis

Manufacturing industries experts continuously try to optimize their operational activities with the help of mathematical techniques or operations research techniques. In context to Plant location analysis, popular methods are as follows:

1. Factor rating method
2. Weighted factor rating method
3. Load-distance method
4. Centre of gravity method
5. Locational Cost-Profit-Volume Analysis

The complete description and explanation of all these methods has been given below

**Factor Rating Method:** The following steps are included in the process of choosing a new facility location:

1. Determine the most critical location factors.
2. Give each component a rating based on its relative relevance; higher ratings indicate a more important factor.
3. Assign each place to each category based on the merits of the site.
4. Multiply the factor allocated to each place by the basic criteria taken into account to calculate the rating for each location.
5. Add up the total product for each factor and choose the best place with the highest total score.



**Example :** Let's assume that a new food production plant is going to be built in Bangalore. The following table shows the location factors, factor ratings, and scores for two proposed sites. Which location is the best based on the factor rating method?

S.No	Location Factor	Factor Rating	Rating Option A	Rating Option B
1	Geographical logistics	8	7	5
2	Environmental impacts	7	5	4
3	Government incentives	6	5	4
4	Local labor market	3	2	1
5	Utilities	5	4	3

**Solution :**

S.No	Location Fcator	Factor Rating	Rating Option A	Total Factor Rating for Option A	Rating Option B	Total Factor Rating for Option B
1	Geographical logistics	8	7	8X7=56	5	5X8=40
2	Environmental impacts	7	5	7X5=35	4	7X4=28
3	Government incentives	6	5	6X5=30	4	6X4=24
4	Local labor market	3	2	3X2=6	1	3X1=3
5	Utilities	5	4	5X4=20	3	5X3=15
			Total	147	Total	110

It has been found from the total factor rating, the value for option A is higher (i.e 147) than option B (i.e 110), hence location A will be selected for establishment of food production plant.

**Weighted factor rating method:** This approach of combining quantitative and qualitative factors assigns weights to factors based on relative relevance, and a weightage score for each site is derived using a preference matrix. The best option is determined by the site with the highest weighted score.



**Example :** Let's assume that a new food production plant is going to be built in Bangalore. The following table shows the location factors, weights, and scores (1 = Poor and 5 = excellent) for two proposed sites. Out of these two proposed sites for food manufacturing plant, which one will be selected according to weightage factor rating method?

S.No	Location Fcator	Weights	Scores for Option A	Scores for Option B
1	Geographical logistics	25	7	3
2	Environmental impacts	25	5	4
3	Government incentives	25	5	4
4	Local labor market	15	2	1
5	Utilities	10	4	3

**Solution :**

The weighted score for respective site is computed by multiplying the weight of each factor by its score and adding the results:

In this case, it can be calculated as follows:

$$\text{Weight Score for option A} = 25 \times 7 + 25 \times 5 + 25 \times 5 + 15 \times 2 + 10 \times 4 = 175 + 125 + 30 + 40 = 370$$

$$\text{Weight Score for option B} = 25 \times 3 + 25 \times 4 + 25 \times 4 + 15 \times 1 + 10 \times 3 = 75 + 100 + 100 + 15 + 30 = 320$$

As explained earlier in this method, best option is determined by the site with the highest weighted score. Hence Option A (Weightage Score = 370) will be selected.

**Load-distance method:** The load-distance technique is a mathematical model for evaluating sites based on their proximity to one another. The goal is to choose a site that reduces the total weighted loads entering and leaving the facility. When two points are assigned to grid coordinates on a map, the distance between them is stated. Instead of using distance, time can be used as an alternative.



### Measurements of Distance

Assume a new warehouse is being built to serve Delhi. Several vendors, including one in Ghaziabad, will send inbound cargo. What would be the distance between the two facilities if the new warehouse were in Gurgaon? The distance travelled by truck is determined by the highway system and the route taken. The exact mileage between any two places in the same county can be calculated using computer software. However, a rough estimate that is either Euclidean or rectilinear distance measure can be employed for the load-distance approach. The straight-line distance, or shortest possible path, between two places is known as Euclidean distance.

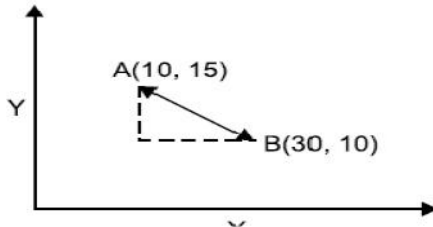

Figure : The distance between point A and B

The supplier's location in Ghaziabad is represented by point A on the grid, and the prospective warehouse location in Gurgaon is represented by point B. The length of the hypotenuse of a right triangle is the distance between points A and B, or

$$d_{AB} = \text{Sqrt}((X_A - X_B)^2 + (Y_A - Y_B)^2)$$

where  $d_{AB}$  = distance between point A and B

$X_A$  = x-coordinate of point A

$Y_A$  = y-coordinate of point A

$X_B$  = x-coordinate of point B

$Y_B$  = y-coordinate of point B

Rectilinear distance is a measurement of the distance between two places that are separated by a sequence of 90° turns, similar to city blocks. This distance is essentially the sum of the two dashed lines in the illustration that denote the triangle's base and side. The absolute value of the difference in x-coordinates is the distance travelled in the x-direction. When you multiply this result by the absolute value of the difference in y-coordinates, you get

$$D_{AB} = |X_A - X_B| + |Y_A - Y_B|$$

### Calculation of Load - Distance Score

Assume that a company planning a new location wishes to choose a location that minimises the distances that loads, especially larger ones, must travel to and from the location. A load can be shipments from suppliers, between factories, or to customers, or it can be customers or staff travelling to or from the facility, depending on the industry. The company aims to reduce load distance by picking a place where huge loads may travel small distances.

To compute a load-distance for any feasible location, we simply multiply the loads flowing to and from the facility by the distances travelled, using either of the distance measures. These burdens can be expressed in terms of tones or weekly travels. This necessitates a practical illustration in order to grasp the concept's significance. Let us consider new health-care centre as example once again and then explain this method as follows .



**Example :** Seven census areas in Delhi will be served by the new health-care facility. The coordinates for the centre of each census tract, as well as the anticipated populations in thousands, are shown in the table below. Customers will travel to the new hospital from the seven census tract centres when they require medical attention. The centres of census tracts C and F are (5.5, 4.5) and (7, 2), respectively, and are being considered for the new facility. The following table lists the population of seven census tract centres, as well as their co-ordinate distances. Which location has a better total load-distance score if we use the population as the loads and utilise rectilinear distance?

Sl. No.	Census tract	(x, y)	Population (P)
1	A	(2.5, 4.5)	2
2	B	(2.5, 2.5)	5
3	C	(5.5, 4.5)	10
4	D	(5, 2)	7
5	E	(8, 5)	10
6	F	(7, 2)	20
7	G	(9, 2.5)	14

**Solution :** Calculate each location's load-distance score. Using the coordinates from the table above as a starting point. Calculate each tract's load-distance score and formula for distance calculation is

$$D_{AB} = |X_A - X_B| + |Y_A - Y_B|$$

Census tract	(x, y)	Population (P)	Locate at (5.5, 4.5)		Locate at (7, 2)	
			Distance (d)	Load-distance	Distance (d)	Load-distance
A	(2.5, 4.5)	2	3 + 0 = 3	6	4.5 + 2.5 = 7	14
B	(2.5, 2.5)	5	3 + 2 = 5	25	4.5 + 0.5 = 5	25
C	(5.5, 4.5)	10	0 + 0 = 0	0	1.5 + 2.5 = 4	40
D	(5, 2)	7	0.5 + 2.5 = 3	21	2 + 0 = 2	14
E	(8, 5)	10	2.5 + 0.5 = 3	30	1 + 3 = 4	40
F	(7, 2)	20	1.5 + 2.5 = 4	80	0 + 0 = 0	0
G	(9, 2.5)	14	3.5 + 2 = 5.5	77	2 + 0.5 = 2.5	35
			Total	239	Total	168

When the facility is placed at (5.5, 4.5), the total load-distance score is 239, compared to 168 when the facility is located at (5.5, 4.5). (7, 2). As a result, the site in census tract F is preferable.

**Centre of Gravity Method:** Cost is the primary factor in determining the centre of gravity. This strategy can help managers strike a balance between cost and service goals. When determining the ideal site for a single intermediate warehouse, the centre of gravity technique considers the locations of plants and marketplaces, the volume of items moved, and transportation costs. The centre of gravity is defined as the position where the weighted distance between the warehouse and its supply and distribution locations is minimised, with the distance being weighted by the number of tones provided or consumed. The initial stage in this technique is to plot the coordinates of the places. The coordinate system's origin and scale can be whatever you choose as long as the relative distances are accurately represented. Placing a grid over an ordinary map is a simple way to accomplish this. The formula determines the centre of gravity.

$$C_X = \frac{\sum D_{ix} \cdot W_i}{\sum W_i} \quad C_Y = \frac{\sum D_{iy} \cdot W_i}{\sum W_i}$$

where  $C_x$  = x-coordinate of the centre of gravity

$C_y$  = y-coordinate of the centre of gravity

$D_{ix}$  = x-coordinate of location  $i$

$D_{iy}$  =  $y$ -coordinate of location  $i$



Example : Determine the center of gravity location for these destinations

Destination	$x,y$ Coordinates	Weekly Quantity
D1	3,5	20
D2	6,8	10
D3	2,7	15
D4	4,5	15
		60

Solution: In order to calculate the coordinates of center of gravity we can use this formula as given below :

$$C_X = \frac{\sum D_{ix} \cdot W_i}{\sum W_i} \quad C_Y = \frac{\sum D_{iy} \cdot W_i}{\sum W_i}$$

$$C_x = \frac{3(20) + 6(10) + 2(15) + 4(15)}{60} = \frac{210}{60} = 3.5$$

$$C_y = \frac{5(20) + 8(10) + 7(15) + 5(15)}{60} = \frac{360}{60} = 6.0$$

Center of gravity = (3.5, 6)

**Locational Cost-Profit-Volume Analysis:** The use of cost-profit-volume analysis facilitates the economic assessment of location choices. The analysis can be done in a number of ways, including quantitatively and graphically. The graphical technique will be used to convey the topic because it improves understanding and shows the ranges in which one of the alternatives is superior to the others. The steps in performing a locational cost-profit-volume analysis are as follows:

1. Calculate the fixed and variable expenses for each alternative location.
2. On the same graph, plot the total-cost lines for all location alternatives.
3. Determine the location with the lowest total cost for the predicted output level.

Alternatively, figure out which place will make the most money. This method is based on the following assumptions:

1. For the range of likely production, fixed costs remain constant.
2. For the range of likely output, variable costs are linear.
3. The desired output level can be roughly determined.
4. There is only one product involved.

For a cost analysis, compute the total cost for each location:

$$\text{Total cost} = FC + vXQ$$

where

FC = Fixed cost

$v$  = Variable cost per unit

$Q$  = Quantity or volume of output



Example: The following are the fixed and variable costs for four potential plant locations:

Location	Fixed Cost per Year	Variable Cost per Unit
A	\$250,000	\$11
B	100,000	30
C	150,000	20
D	200,000	35

- On a single graph, plot the total-cost lines for these sites.
- Determine the output range for which each option is superior (i.e., has the lowest overall cost).
- Which location would have the lowest total cost if the estimated output at the chosen location is 8,000 units per year?

Solution:

- Select an output that is about equal to the projected production level to depict the total-cost lines (e.g., 10,000 units per year). Calculate the total cost at that level for each location:

	Fixed Cost	+	Variable Cost	=	Total Cost
A	\$250,000	+	\$11(10,000)	=	\$360,000
B	100,000	+	30(10,000)	=	400,000
C	150,000	+	20(10,000)	=	350,000
D	200,000	+	35(10,000)	=	550,000

Plot the fixed cost (at Output 0) and total cost (at 10,000 units) for each place, then draw a straight line connecting the two locations. (For a visual representation of this, see the graph below.)

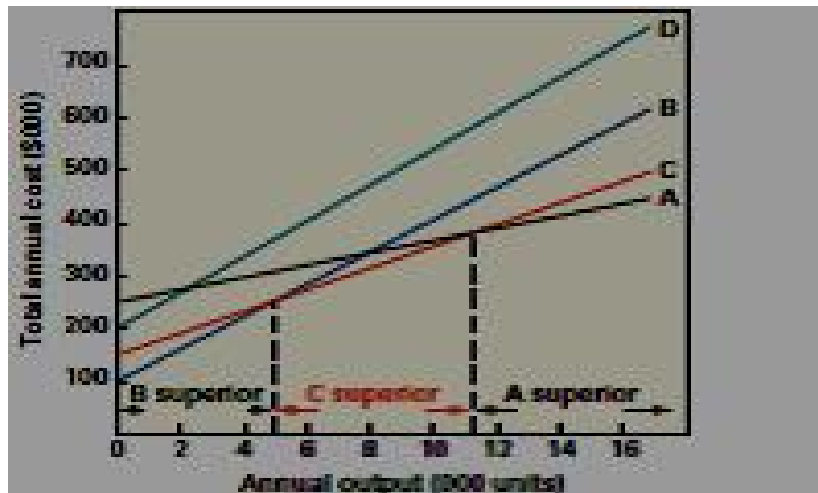

- The graph depicts the approximate cost ranges for which the various alternatives will produce the lowest expenses. It's worth noting that spot D is seldom the best. The output levels at which lines B and C and lines C and A cross can be used to identify the exact ranges. Set their total cost equations equal and solve for  $Q$ , the break-even output level, to accomplish this.

Therefore for alternative B and C

$$\begin{array}{l} \text{B} \\ 100,000\$ + 30\$ Q = \\ \text{C} \\ 150,000\$ + 20\$ Q \end{array}$$

After solving this equation,  $Q = 5,000$  units per year

Similarly for alternative C and A

$$\begin{array}{l} \text{C} \\ 150,000\$ + 20\$ Q = \\ \text{A} \\ 250,000\$ + 11\$ Q \end{array}$$

After solving this equation,  $Q = 11,111$  units per year.

c. From the graph, you can see that for 8,000 units per year, location C provides the lowest total cost.

For a profit analysis, compute the total profit for each location:

$$\text{Total profit} = Q(R - v) - FC$$

where

$R$  = Revenue per unit

## Summary

- As plant site selections are strategic and long-term in nature, the location of the plant itself becomes a highly crucial element when it comes to service facilities.
- An ideal location is one where the product's cost is maintained to a minimum, the market share is huge, the risk is low, and the social benefit is high.
- It is the location with the greatest net advantage or the lowest unit cost of production and delivery.
- Small-scale businesses can employ location analysis to accomplish this goal.
- Due of various factors, the strategic character of the plant placement decision necessitates a very extensive analysis.
- However, the decision is taken only after weighing the various costs and weighing the advantages of several alternative places.
- Identifying a country or region that appears to meet overall criteria and then identifying a number of community-site alternatives for additional in-depth analysis is a popular strategy of narrowing the range of location alternatives.
- Location choices are assessed using a variety of ways. such as Locational cost-profit-volume analysis, factor rating, and the centre of gravity method are among those discussed in the chapter.

## Keywords

**Location Planning:** It is the planning system in which Corporations can opt to expand an existing location, close one and relocate to another, open new locations while keeping current facilities, or do nothing.

**Facility:** A facility can refer to any physical object that is relevant to location analysis, such as a factory, hospital, or bank.

**Raw Material Availability :** This implies that the raw material must be accessible within a reasonable distance. Easy access to supplies needed for plant maintenance and operation should also be considered.

**Established Industry's Momentum :** It means that existing industries in a given area will create trained labour for that work in the respective industry. As a result, future industries in that area will have no trouble finding skilled labour.

**Planned Industrial Centres:** While large industrial houses or the government may design and build industrial towns, the current tendency is to develop areas as industrial estates and sell them to persons interested in establishing businesses in diverse locations. This style of development may be seen in Noida and Faridabad as the planned industries centres in NCR region of India .

**Infrastructure:** In case of plant location analysis , infrastructure includes the availability and reliability of power, water, fuel, and communication infrastructure.

**Legislation and Taxation:** Financial and other incentives for new companies in underdeveloped areas or no-industry-district centres, exemption from certain state and local taxes, octroi, and other factors are critical.

**Community Facilities:** These include things like quality of life, which is determined by the availability of facilities such as schools, places of worship, medical services, police and fire stations, cultural, social, and recreational opportunities, housing, and good streets and communication and transportation facilities.

**Topography:** Topography, soil structure, and drainage must all be appropriate. If significant land improvement is necessary, low-cost land may prove to be costly.

### **SelfAssessment**

1. Crude oil extraction started incurring higher cost of operations as compared to revenues. Company might search new reserves. Decision to change location is based on:
  - A. Marketing strategy
  - B. Depletion of resources
  - C. Cost of doing business
  - D. All of the above
  
2. Companies opened manufacturing units in China and India owing to cheap labor. Decision of new location is based on:
  - A. Tax and regulations
  - B. Talent retention
  - C. Cost of doing business
  - D. All of the above
  
3. Free trade agreements may result in relocation of companies. Decision of relocation is based on:
  - A. Tax and regulations
  - B. Talent retention
  - C. Cost of doing business
  - D. All of the above
  
4. Location planning is important for:
  - A. Expanding existing facilities
  - B. Adding new facilities
  - C. Moving to new geographies
  - D. All of the above
  
5. Which of the following should be considered while evaluating location options?
  - A. Selection criteria
  - B. Factors identification
  - C. Ratings for each factor
  - D. All of the above
  
6. Which of the following is a regional factor affecting location decision
  - A. Raw material availability

- B. Environmental regulations
  - C. Market area plant strategy
  - D. None of the above
7. Which of the following is a community factor affecting location decision.
- A. Raw material availability
  - B. Environmental regulations
  - C. Market area plant strategy
  - D. None of the above
8. Which of the following factors are related to multiple production units, affecting location decision?
- A. Product plant strategy
  - B. Process plant strategy
  - C. Market area plant strategy
  - D. All of the above
9. Land and transportation are related to which factors affecting location decision?
- A. Regional factors
  - B. Community factors
  - C. Manufacturing site related factors
  - D. None of the above
10. Climate and taxes are related to which factors affecting location decision?
- A. Regional factors
  - B. Community factors
  - C. Manufacturing site related factors
  - D. None of the above
11. Which of the following best explains CVP process in location planning?
- A. Multiple options are evaluated for minimum cost
  - B. Break even volumes are considered for each option
  - C. Multiple options are evaluated for maximum profit in desired volume range
  - D. None of the above
12. Which of the following are true for factor rating?
- A. Relevance of factors may vary with industry
  - B. Relevance of factors may vary within industry
  - C. All locations can be evaluated by scoring related factors
  - D. All of the above

13. If two plants A & B operates at same capacity, warehouse location identified through center of gravity method will be:
- At the center of A & B and on the line connecting them
  - Towards A or B but on the line connecting them
  - At any point equi-distant from A & B
  - Insufficient information
14. If Plant A operates at twice the capacity of plant B, warehouse location identified through center of gravity method will be:
- At the center of A & B and on the line connecting them
  - Towards A on the line connecting them
  - Towards B on the line connecting them
  - Insufficient information
15. In center of gravity method, weights to factors are given on the basis of:
- Total cost
  - Quantities
  - Travel time
  - All of the above

**Answers for Self Assessment**

- |       |       |       |       |       |
|-------|-------|-------|-------|-------|
| 1. C  | 2. C  | 3. A  | 4. D  | 5. D  |
| 6. A  | 7. B  | 8. D  | 9. C  | 10. A |
| 11. C | 12. D | 13. A | 14. A | 15. D |

**Review Questions**

- What impact does the choice of location have on the manufacturing system of an automobile company?
- Give your opinion to the following statement: "The importance of the location selection is sometimes greatly exaggerated; the fact that almost any form of business can be found in every part of the country suggests that choosing a good location should be no problem."
- What characteristics in the community influence location decisions?
- What are the advantages of locating in another country? Potential disadvantages?
- How does factor rating function and what is it?
- Describe the overall strategy for developing alternative locations.
- What are the fundamental assumptions that go into a locational cost-profit-volume analysis?
- Discuss current location patterns and potential future tactics.
- Consider the following situation and explain.



### Unit 04: Plant Location Analysis

A corporation is thinking about moving its manufacturing plant and administrative offices from a tiny Midwest city to a similar-sized Southern metropolis. Approximately 20% of the city's citizens work for the corporation, and many more work in businesses like banks, personal services, restaurants, shopping centres, and supermarkets that would see a drop in business if the company decided to relocate. Is it the company's social responsibility to consider the impact of its shift on the city when making its decision? Justify your decision.

10. In some countries, corruption and bribery are common. Would you rather avoid such a country than go there and deal with it? What would you do if it turned out to be the latter?

11. Solve the following numerical problem.

A recreational silver items manufacturer has decided to expand one of its lines. Because the company's current facilities are insufficient to handle the additional workload, it is exploring three options: A (new location), B (subcontract), and C (relocation) (expand existing facilities). Alternative A would have high fixed expenses but low variable costs: \$250,000 per year in fixed costs and \$500 per boat in variable costs. Subcontracting would cost \$2,500 per boat, while expansion would cost \$50,000 per year in fixed costs and \$1,000 per boat in variable costs.

- a. Determine the output range for each alternative that will result in the lowest total cost.
- b. For an annual volume of 150 boats, which option would result in the lowest total cost?
- c. What other variables should be considered when deciding whether to expand or subcontract?

12. A food plant located in North Delhi will incur certain annual fixed expenses, variable costs, and revenue. For a site in North Mumbai, the 0 values might be different. The table below shows the fixed costs, variable costs, and price per unit for both sites. Consider that expected sales volume in this situation is 96 tonnes. Select the suitable location with the help of break even point method of location analysis

Plant Location Option	Fixed Cost	Variable Cost	Price /Tonne
North Delhi	45,00,000	350,00	85000
North Mumbai	65,00,000	260,00	80000



### Further Readings

- Look Beyond the Obvious in Plant Location by Roger W. Schmenner.
- **Factors Governing Plant Location available at website**  
<https://www.ukessays.com/essays/business/factors-governing-plant-location-business-essay.php> publishe in 20217.
- Research article entitled as "Economic, social, and environmental cost optimization of biomass transportation: a regional model for transportation analysis in plant location process" and published in 2019 in journal " *Biofuels, Bioproducts and Biorefining*, 13(3), 582-598."



### Web Links

- <https://hbr.org/1979/01/look-beyond-the-obvious-in-plant-location>
- [https://archive.org/stream/PlantLocationAndLayout/PlantLocationAndLayout\\_djvu.txt](https://archive.org/stream/PlantLocationAndLayout/PlantLocationAndLayout_djvu.txt)
- <https://www.ukessays.com/essays/business/factors-governing-plant-location-business-essay.php>

## Unit 05: Quality Management

### CONTENTS

Objectives

Introduction

5.1 Dimensions of Quality

5.2 Elements of Quality

5.3 Quality Control

5.4 Quality Control Tools

5.5 Total Quality Management

5.6 Concept of Inspection

5.7 Statistical Process Control

Summary

Keywords

Self Assessment

Answers for Self Assessment

Review Questions

Further Readings

### Objectives

After studying this unit, you will be able to:

- Understand the relevance of quality parameters for the overall success of an organization
- Get familiarity with the basics of quality, quality management, and how they are used for the sound quality system of an organization
- Understand the various tools and statistical methods that are used in quality management.

### Introduction

Profit is the ultimate goal of any commercial firm. Various ways can be used to accomplish this. Cutting costs for the same selling price per unit might increase profit. If it's a monopoly business, the price can be set appropriately to produce a sufficient profit without putting much emphasis on cost-cutting efforts. However, in order to rent competitive business climate, a company's goods and services must meet certain quality standards. Extra quality comes at a price. As a result, the product's degree of quality should be determined in relation to other asp about for it to for received on the market. Basic quality is considered to be one of the supporting variables in all of these scenarios in order to have recurring tohus higher sales revenue. Quality refers to how closely a product or service adheres to a set of specifications. Anyone or a combination of qualities and variables of the product being created can be used as quality criteria. Performance, reliability, appearance, commitment to delivery time, and so on are some of the features. Variables include length, width, height, diameter, surface polish, and so on.

### 5.1 Dimensions of Quality

Under different circumstances, the word quality could have varied connotations term "quality" does not solely refer to the quality of a manufactured product. It can refer to the process quality (i.e., men, material, and machines) as well as management quality. Where the term "quality

produced product" refers to or is defined as "the degree to which a product meets the needs of the consumer." It isn't absolute, but it may be measured or realized by comparing it to certain benchmarks. Quality begins with the design of a product by the customer's specifications and goes on to include established measurement standards, the use of appropriate materials, and the selection of a suitable manufacturing process, among other things. Quality is a relative term that is usually applied to the product's end-use. "Quality" is defined by Crosby as "conformance to requirements or specifications." "Quality is fitness for use," said Juran. "The fitness of a product or service to meet or surpass its intended usage as needed by the client is the quality of that product or service."

#### **The Dimensions of Quality:**

The degree to which a product's or service's performance meets or exceeds consumer expectations is one way to think about quality. The distinction between these two, namely Performance – Expectations, is fascinating. If the difference between these two indicators is zero, expectations have been met. If the difference is negative, the customer's expectations have not been satisfied; if the difference is positive, the performance has exceeded their expectations. Customers use a variety of categories, or dimensions, to rate the quality of a product or service, which can be split down into several dimensions. Understanding these factors aids businesses in meeting or exceeding client expectations. The dimensions of goods differ from those of people.

In the case of pure tangible products, The product's major attributes are its performance. Appearance, feel, smell, and taste are all aspects of aesthetics. Extra qualities are known as special features. Conformance refers to how closely a product adheres to design specifications. Reliability refers to a product's capacity to deliver consistent results. Durability refers to a product's capacity to perform over time. Perceived quality is an indirect way of assessing quality (e.g., reputation). Serviceability refers to how complaints or repairs are handled.

On the other hand in the case of services quality dimensions are as below

- Convenience – the service's availability and accessibility.
- Reliability is defined as the capacity to provide a service consistently, accurately, and reliably. Responsiveness refers to a service provider's willingness to assist clients in unique situations and solve problems.
- Time – the rate at which a service is provided.
- Assurance is the ability of individuals who come into contact with a consumer to transmit trust and confidence through their knowledge.
- Customers are treated with courtesy by personnel who come into contact with them.
- The physical look of facilities, equipment, staff, and communication materials are known as tangibles.
- Consistency – the capacity to consistently deliver a high degree of quality.

## **5.2 Elements of Quality**

There are four key criteria of whether a product or service successfully fulfills its intended purpose:

1. Create a design.
2. The degree to which the product or service adheres to the design.
3. Usability.
4. After-delivery service

The design phase is the beginning point for the quality level that will be achieved in the end. Design entails making judgments on a product's or service's specific qualities, such as size, form, and location. The purpose of designers to include or exclude particular characteristics in a product or service is referred to as design quality. Automobiles, for example, come in a wide variety of types today. Size, look, roominess, fuel economy, comfort, and materials utilized all differ. These distinctions indicate designer decisions that influence design quality. Customer desires, production or service capabilities, safety and liability (both during production and after delivery), costs, and other comparable issues must all be factored into design decisions.

A bad design might cause problems in production or service. Materials, for example, maybe tough to come by, standards may be difficult to achieve, and procedures may be difficult to follow. Furthermore, even the best workmanship in the world may not be enough to attain the necessary quality if the design is inadequate or incorrect for the circumstances. Furthermore, we cannot expect a worker to produce good results if the tools or procedures available to them are insufficient. Similarly, a great design can't always compensate for shoddy construction.

The degree to which goods and services conform to (i.e., achieve) the designers' objective is referred to as conformance quality. Elements such as the competence of the equipment utilized; worker skills, training, and motivation; the extent to which the design lends itself to production; the monitoring method to assess compliance; and the taking of corrective action are all factors that influence this mechanism of quality assurance.

The process of determining quality does not end when the product or service is sold or delivered. User instructions and ease of use are critical. They raise the possibilities of a product being used for its intended purposes and in a way that ensures it continues to perform effectively and safely, but they do not guarantee it. (In the event of a liability lawsuit, firms frequently claim that injuries and damages were caused by the user's abuse of the product.) When it comes to services, much of the same logic applies. Customers, patients, clients, and other users must be well-informed about what they should and should not do; otherwise, there is a risk that they will take action that will harm quality.

A doctor who fails to clarify that a drug should be taken before meals and not with orange juice, and an attorney who fails to inform a client of a claim filing deadline are two examples. A lot of consumer education is done through written instructions and labels. As a result, manufacturers must make sure that instructions for unpacking, assembling, using, maintaining, and adjusting the product—as well as what to do if something goes wrong (e.g., flush eyes with water, call a doctor, induce vomiting, do not induce vomiting, disconnect set immediately)—are easily visible and understandable. Products do not always operate as planned, and services do not always produce the desired results for a variety of reasons. Whatever the cause, it's critical to rectify the situation—whether by product recall and repair, adjustment, replacement or buyback, or reevaluation of service—and do whatever it takes to bring the product or service up to standard.

**Costs associated with Quality:** Any serious effort to address quality issues must consider the expenses involved with quality. These expenses can be divided into three groups: appraisal, prevention, and failure. Inspection, testing, and other operations aimed at uncovering or ensuring the absence of defective items or services are included in appraisal expenses. Inspectors, testing, test equipment, labs, quality audits, and field testing are all included.

Attempts to prevent flaws are referred to as *Prevention costs*. Costs such as planning and administration systems, working with vendors, training, quality control methods, and extra attention in the design and production phases to reduce the likelihood of poor workmanship are all included. Defective parts or products, as well as poor services, incur failure costs. Internal failures are identified during the manufacturing process, while external failures are discovered after the product has been delivered to the consumer. Defective material from vendors, inaccurate machine settings, bad equipment, incorrect methods, incorrect processing, negligence, and faulty or unsuitable material handling processes are all examples of internal failures. Internal failures cost money in terms of lost production time, scrap and rework investigative fees, possibly equipment damage, and potential personnel turnover.

The salary of workers as well as the additional resources required to complete the rework are included in the rework cost (e.g., equipment, energy, raw materials). Inspection of reworked components, schedule interruption, the increased expenses of parts and materials in inventory waiting for reworked parts, and the paperwork required to track the things until they can be reintegrated into the process are all factors that must be considered. Defective items or bad service that go unnoticed by the manufacturer are examples of external failures. Warranty work, complaint management, replacements, liability/litigation, payments to consumers or discounts used to offset the poorer quality, loss of customer goodwill, and opportunity costs connected to lost sales are some of the costs that result.

### 5.3 Quality Control

Quality control (QC) is a technique or group of procedures used to guarantee that a manufactured product or service fulfills a predetermined set of quality criteria or the client's or customer's

expectations. Quality control is comparable to, but not the same as, quality assurance (QA). Furthermore, A system for maintaining the desired degree of quality in a product or service is known as quality control (QC). It is the systematic monitoring of numerous aspects that influence the product's quality. Materials, tools, equipment, type of labor, working environment, and other factors all play a role.

QC is a broad phrase that encompasses inspection at many stages, although inspection alone does not imply quality control. Quality control, as opposed to inspection, is concerned with the quality of future production.

Quality control relies on an effective feedback system and corrective action mechanism to prevent faults at the source. Inspection is an important instrument in quality control.

"Quality control is the regulatory process by which we monitor actual quality performance, compare it to standards, and take action based on the difference," Juran says.

The creation of well-defined controls is an important part of quality control. These controls aid in the standardization of both production and quality-control responses. Limiting the margin for error by identifying which production activities are to be accomplished by which workers decreases the risk of employees being assigned tasks for which they are unprepared.

In the absence of an effective quality control system, the following negative consequences may occur

1. There is no standard by which to compare the quality of goods and services.
2. Difficulty in maintaining quality consistency.
3. Dissatisfied customers as a result of higher product/service maintenance and operational costs.
4. Higher rework costs while producing items or offering services.
5. Products/services have a shorter life span.
6. Less flexibility when it comes to the use of conventional spare parts.
7. As a result, quality control is a necessary task

### **Types of Quality Control**

Quality control is not the responsibility of a single department or individual. Any supervisor's principal task is to produce work of acceptable quality.

The following are the three primary sub-areas of quality control:

Off-line quality control, statistical process control, and acceptance sampling plans are the three types of quality control.

1. *Off-line quality control*: This approach involves taking steps to choose and choose a controllable product and process parameters in such a way that the variation between the product or process output and the standard is as small as possible. The design of products and processes helps with a lot of this. Taguchi technique, principles of experimental design, and so on are examples.

2. *Statistical process control*: SPC entails comparing a process' or service's output to a standard and taking corrective action if there is a disparity. It also entails analyzing whether a procedure can generate a product that fits the specified or required specifications. On-line SPC refers to gathering information about a product, process, or service while it is in use. During the operational phase, corrective action is taken. This is based on a real-time basis.

3. *Acceptance sampling plans*: An acceptance sampling plan is a plan that determines the number of items to sample and the lot's acceptance criteria based on meeting certain defined parameters (such as the risk of rejecting a good lot or accepting a bad lot).

### **Objectives of Quality Control**

The following are the quality control objectives:

1. To increase the company's revenue by improving customer acceptance of the product, such as by offering longer life, more usability, and maintainability, among other things.
2. To save company costs by reducing defect-related losses.
3. To accomplish manufacturing interchangeability in large-scale production.

4. To make high-quality goods at a low cost.
5. To assure customer satisfaction with products or services of a high-quality level, as well as to build consumer goodwill, confidence, and the manufacturer's reputation.
6. To ensure quality control, do inspections as soon as possible.
7. To monitor deviation during the manufacturing process.

Incoming material control, process control, and product control are three primary areas of use for quality control.

**Note:**

- To develop the culture of quality concern in the industry, quality awards were initiated to motivate the organizations, Quality awards have been established to promote quality improvement.
- The Malcolm Baldrige Award, the European Quality Award, and the Deming Prize are all well-known honors that are given out each year to companies that have successfully incorporated quality management into their operations.

## 5.4 Quality Control Tools

Organizations employ graphical tools to make reasonable decisions based on data acquired from the product, process, or consumer. These techniques assist us in learning about the characteristics of a process, its current state of operation, and the type of output we can expect. Graphical approaches are simple to comprehend and provide extensive data; they are an effective tool for analyzing product and process data. These tools have a positive impact on quality. The following are the seven quality control tools:

- Check sheets
- Pareto charts
- Cause and effect diagram
- Scatter diagrams
- Histogram
- Graphs or flow charts
- Control charts

*Check sheets:* These sheets make systematic record keeping or data collecting easier by recording observations as they happen, revealing patterns and trends. The use of a checklist to collect data is frequently the initial step in the study of quality concerns. A checklist is a document that is used to keep track of the frequency with which particular product or service attributes linked to quality occur. Weight, diameter, duration, and length are examples of attributes that can be measured on a continuous scale.



**Example:** The tabulated figure serves as a checklist for a company's computer-related issues.

COMPONENTS REPLACED BY LAB	
TIME PERIOD: 22 Feb. to 27 Feb. 2005	
REPAIR TECHNICIAN: XYZ	
TV SET MODEL 1013	
Integrated Circuits	
Capacitors	
Resistors	
Transformers	
Commands	
CRT	

Figure: 5.1 checklist for a company's computer-related issues.

**Pareto charts:** By arranging items in decreasing order of importance, Pareto charts assist with prioritization. These diagrams assist firms in determining the sequence in which they should solve challenges in a limited resource setting.

The Pareto analysis can be used in a variety of ways to pinpoint the issue.

- Material-by-material analysis of losses (number or past number).
- Loss analysis by process, i.e., defect or lot rejection classification in terms of the process.
- Losses via product family analysis.
- Supplier-by-supplier analysis over the whole purchase spectrum.
- A cost-of-parts analysis.
- Failure mode analysis.

A Pareto chart of factors for poor quality is shown in Fig. 5.2. According to 64 percent of respondents, poor design will be the primary cause. As a result, this is the first issue that the production unit should solve.

- A – Ineffective Design
- B – Faulty Components
- C – Operator Error
- D – Incorrect Dimensions
- E – Abrasion on the Surface
- F – Calibrations of Machines
- G – Faulty Material

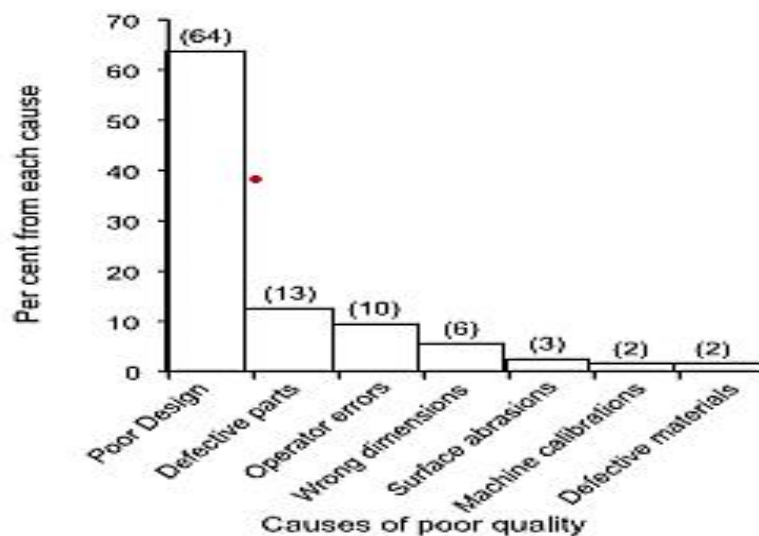

Figure 5.2: Pareto chart of reasons for poor quality

**Cause and Effect Diagram:** It's also known as a Fishbone diagram. It was invented by Kaoru Ishikawa in 1943 and is also known as the Ishikawa diagram. The diagram aids management in tracing consumer complaints to the specific operations concerned. The fish-head is the main quality issue, with the key categories of potential cause structural bones and the likely particular causes to ribs. It investigates potential sources of problems with the goal of identifying the root causes. This graphic aids in identifying potential causes for a process to get out of control, as well as potential consequences.

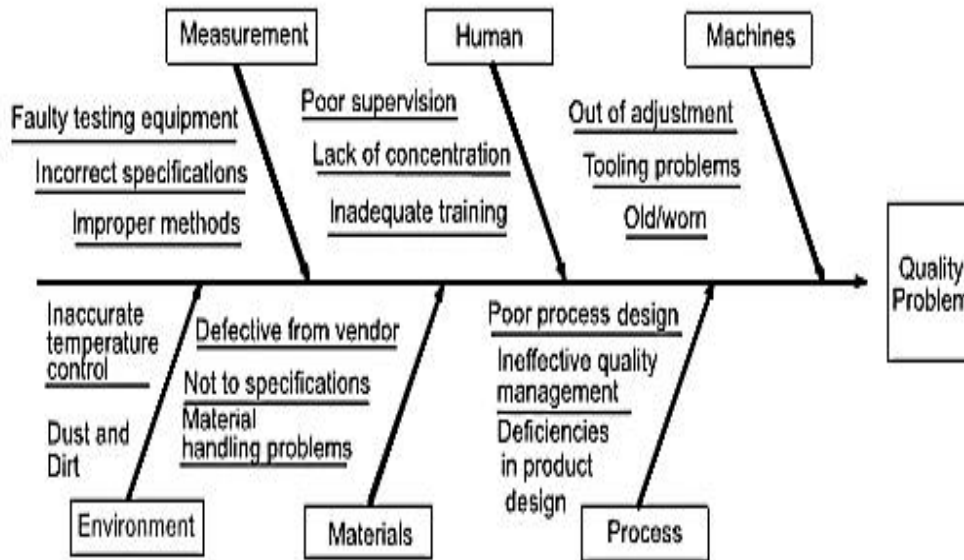

Figure 5.3: Fish Bone Diagram

**Scatter Diagrams:** It is frequently used to show the relationship between two variables. They're frequently used as follow-ups to cause and effect analyses to see if a reported reason actually has an effect on quality features.

Example: Advertising budget is plotted against firm revenue in the graph below, indicating a strong positive link between the two variables. As the amount of money spent on advertising rises, so do sales.

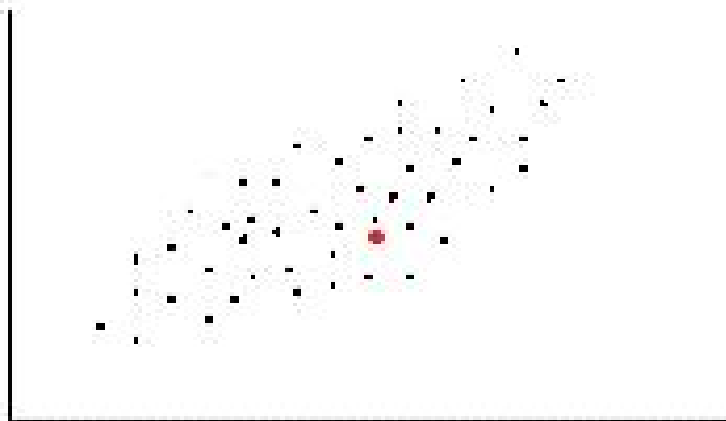

Figure 5.4 Scatter Plot for firm revenue and advertising budget

**Histogram:** It shows vast volumes of data that are difficult to interpret when presented in their raw form. The frequency distribution of some quality criteria is shown in figure 5.5 as a histogram, which summarises data measured on a continuous scale (in statistical terms the central tendency and the dispersion of the data). On the histogram, the data mean is frequently shown. A bar chart is a sequence of bars that show the frequency of occurrence of data characteristics, with the height of the bars indicating the number of times a given quality characteristic was detected.



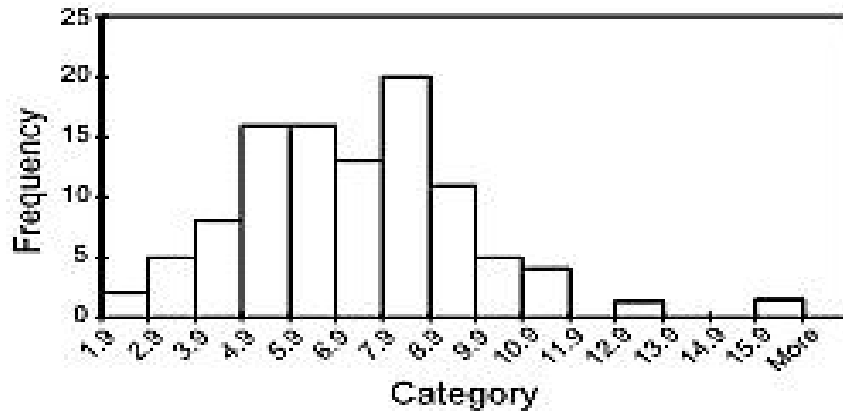

Figure 5.5: Histogram

Graphs or flow charts: These depict the flow of events in a process. They're employed in both manufacturing and service. To simplify a system, flow charts are frequently used to diagram operating procedures. They can spot bottlenecks, unnecessary steps, and operations that aren't adding value.

The knowledge of the people who are directly involved in the process can be used to create a realistic flow chart. The flow chart might help you figure out where delays might arise.

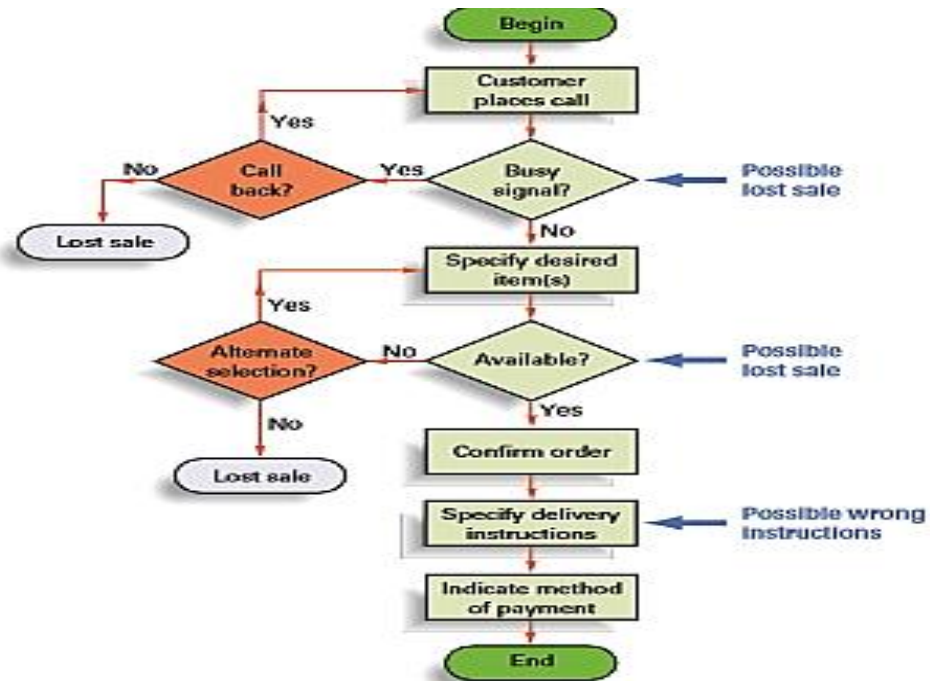

Figure 5.6: Flow Chart

Control charts: It differentiates between special and common causes of variation. They are used to continuously monitor and control processes. A typical control chart depicts a selected quality parameter derived from a subset of observations as a function of sample size. Sample averages, sample ranges, and the proportion of nonconforming units in the sample are all plotted. The average value of the plotted characteristics is represented by the control chart's centerline. Control charts also display two limitations known as the upper control limit (UCL) and lower control limit (LCL). These boundaries are set so that, if the process is working under a stable system of chance causes, the risk of an observation slipping outside of these bounds is minimal.

A control chart depicts a process' performance from two perspectives. First, they display a snapshot of the process as it is happening at the time the data is being gathered. Second, they show how the process evolves over time. Process trends are significant because they aid in determining whether or not an out-of-control situation exists. They also assist in detecting and identifying deviations that are outside of typical operational boundaries. A generalized representation of a control chart is shown in Fig 5.7

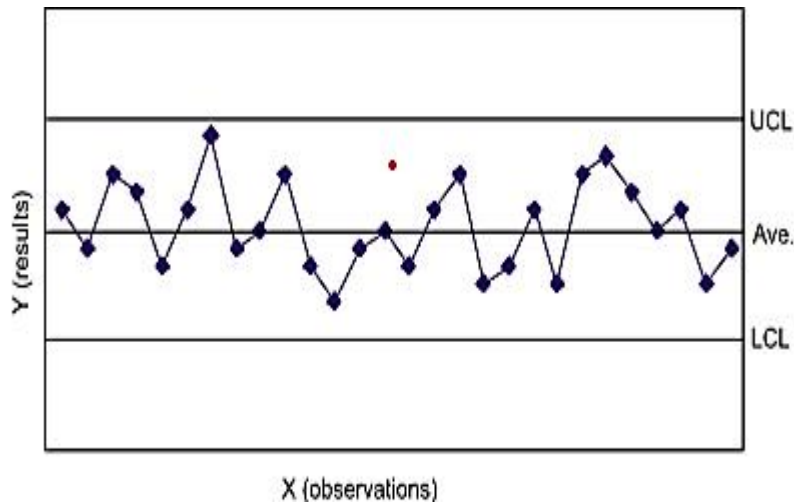

Figure 5.7 Control Charts

**Notes:**

- The sources of variance in product quality in any manufacturing process can be divided into two categories: (a) chance causes and (b) intentional causes. (b) Causes that can be assigned.
- The chance causes are those that are inherited in the production process as a result of the operational and constructional aspects of the equipment used in the process.
- Variation in assignable cause may always be traced back to a single attribute. They happen because of operational incompetence, Inappropriate maintenance procedures, New suppliers, Error in setting jigs and fixtures, and raw material defects.

## 5.5 Total Quality Management

Management's major responsibility is to guide an organization through its everyday operations and to ensure that it remains viable in the future. In both of these goals, quality has become a critical component. Consumer happiness, in customer words, became a particular goal in the late 1980s, while being arguably always a corporate goal. The importance of providing high-quality service was recognized as a critical component of success. The majority of significant firms that have taken this route have demonstrated their success. First, they overcame fierce international competition that had established high-quality standards, and they have now reclaimed some of their old markets. Smaller businesses are pursuing similar objectives. TQM necessitates the involvement of management. An operating philosophy reflects the methodology.

The phrase total quality management (TQM) refers to an organization's strive for excellence. This method is based on three main concepts. The first is a never-ending drive to improve, known as a continuous improvement; the second is everyone in the organization's involvement; and the third is a goal of customer satisfaction, defined as achieving or exceeding customer expectations. TQM goes beyond the traditional definition of quality, which focuses solely on the quality of the finished product or service, to include the quality of every step in the manufacturing process. TQM systems are designed to prevent the occurrence of poor quality.

"Total Quality Management," according to Feigebaum, "is an effective system for integrating the quality development, quality maintenance, and quality improvement efforts of various groups in an organisation in order to enable marketing, engineering, production, and service at the most cost-effective levels while ensuring full customer satisfaction."

TQM's advantages can be divided into two categories:

1. Benefits based on customer satisfaction.
2. Benefits aimed at improving the economy.

1. **Customer satisfaction-oriented benefits:** The following benefits fall within this category:

- (a) Increased product quality.
- (b) Product design enhancements.
- b) An increase in the production flow.
- (d) An increase in employee morale and quality awareness.
- (e) Enhancing product service.
- (f) An increase in market acceptance.

2. Benefits aimed at improving the economy:

The following are the advantages in this category:

- (a) Cost-cutting initiatives.
- (b) Lowering operating losses.
- c) Cost-cutting in field service.
- (d) Liability exposure reductions.

## **5.6 Concept of Inspection**

Inspection is a crucial instrument for realizing the quality concept. It is vital to give the manufacturer confidence and to strive for client satisfaction. Inspection is a critical component of today's production process. It aids in the control of quality, the reduction of manufacturing costs, the elimination of scrap losses, and the identification of the reasons for poor work. The inspection and test unit is in charge of evaluating the quality of incoming raw materials and components, as well as the finished product or service. It inspects the components at different stages based on specified criteria, detecting and sorting out faulty or defective goods. It also detailed the sorts of inspection devices to be used, as well as the methods to be followed for measuring quality parameters.

In the case of variables, inspection merely examines the degree of conformity to a standard. Inspection of qualities just distinguishes the nonconforming from the conforming. The inspection does not reveal why nonconforming units are manufactured. The most popular means of achieving standardization, homogeneity, and quality of workmanship is inspection. It is the cost art of inspecting the quality of a product after it has been compared to predefined standards and specifications. It is a quality control function. If the item does not fall within the acceptable range, it will be rejected, and remedial action will be taken to ensure that similar goods are produced in the future.

### **Objectives of Inspection**

1. To identify and eliminate defective raw materials before they are used in production.
2. To detect faulty products in production as soon as they are discovered.
3. To bring facts to the attention of managers before they get concerned, allowing them to identify flaws and solve the situation.
4. Preventing poor products from reaching customers and lowering complaints.
5. Enhance the product's reputation for quality and dependability.
6. To discriminate between good and bad lots.
7. To tell the difference between good and terrible pieces.
8. Determine whether the process is evolving.
9. To see if the process is getting close to the specification restrictions.
10. To assess the product's quality.
11. To assess inspectors' accuracy.

12. To check the measurement instrument's precision.
13. To protect knowledge about product design.
14. To assess the capabilities of a procedure.

## 5.7 Statistical Process Control

The application of statistical approaches to establish whether the output of a process corresponds to the product or service design is known as statistical process control (SPC). It focuses on preventing rather than detecting poor quality during manufacturing or service. It is concerned with controlling the manufacturing process because if the process is good, the result will be good as well.

Control charts are used to monitor the output of the process and show the presence of problems that require further action in SPC. Control charts can be used to track processes that have outputs that are measured as variables or characteristics. Variable control charts and attribute control charts are the two forms of control charts.

**1. Variable control charts:** These are charts that can be used to measure a product's quality features. The X-BAR chart, R-BAR chart, and SIGMA chart are the three variable control charts.

**2. Attribute control chart:** It is a chart in which the quality features of a product cannot be measured, i.e., it is solely based on visual inspection such as good or terrible, success or failure, accepted or rejected. P-charts, np-charts, c-charts, and u-charts are examples of attribute control charts. Only a count of observations on characteristics, such as the number of nonconforming objects in a sample, is required.

**Control Charts for variables:** These graphs will employ variable data from a process, as the name implies. The X chart shows the central tendency of the observations. These graphs will show the differences in sample observations. The spread (dispersion) of the observations is depicted using an R chart. This graph depicts the differences between the samples.

The formulas used to establish various control limits are as follows: (a) Standard Deviation of the Process,  $\sigma$ , Unknown

**R-Chart:** To calculate the range of the data, subtract the smallest from the largest measurement in the sample.

The control limits are:  $UCL_R = D_4 \bar{R}$  and  $LCL_R = D_3 \bar{R}$

where  $\bar{R}$  = average of several past  $R$  values and is the central line of the control chart, and

$D_3, D_4$  = constants that provide three standard deviation (three-sigma) limits for a given sample size

**$\bar{X}$ -Chart:** The control limits are:

$UCL_{\bar{X}} = \bar{\bar{X}} + A_2 \bar{R}$  and  $LCL_{\bar{X}} = \bar{\bar{X}} - A_2 \bar{R}$

where  $\bar{\bar{X}}$  = central line of the chart and the average of past sample mean's, and

$A_2$  = constant to provide three-sigma limits for the process mean.

### (b) Standard Deviation of the Process, $\sigma$ , Known

Control charts for variables (with the standard deviation of the process,  $\sigma$ , known) monitor the mean,  $\bar{X}$ , of the process distribution.

The control limits are:

$UCL = \bar{\bar{X}} + 2\sigma_{\bar{X}}$

and  $LCL = \bar{\bar{X}} - 2\sigma_{\bar{X}}$

where  $\bar{\bar{X}}$  = centre line of the chart and the average of several past sample means,  $Z$  is the standard normal deviate (number of standard deviations from the average),

$\sigma_{\bar{X}} = \sigma / \sqrt{n}$  and is the standard deviation of the distribution of sample means, and  $n$  is the sample size



**Example:** The Goliath Tool Company produces slip-ring bearings, which look like flat doughnuts or washers. They fit around shafts or rods, such as drive shafts in machinery or motors. At an early stage in the production process for a particular slip-ring bearing, the outside diameter of the bearing is measured. Employees have taken 10 samples (during a 10-day period) of 5 slipping bearings and measured the diameter of the bearings. The individual observations from each sample (or subgroup) are shown as follows:

Subgroup	Observations(Slip Ring Diameter, cm),n					
	1	2	3	4	5	$\bar{x}$
1	5.02	5.01	4.94	4.99	4.96	4.984
2	5.01	5.03	5.07	4.95	4.96	5.004
3	4.99	5	4.93	4.92	4.99	4.966
4	5.03	4.91	5.01	4.98	4.89	4.964
5	4.95	4.92	5.03	5.05	5.01	4.992
6	4.97	5.06	5.06	4.96	5.03	5.016
7	5.05	5.01	5.1	4.96	4.99	5.022
8	5.09	5.1	5	4.99	5.08	5.052
9	5.14	5.1	4.99	5.08	5.09	5.08
10	5.01	4.98	5.08	5.07	4.99	5.026
						50.106

From past historical data it is known that the process standard deviation is .08. The company wants to develop a control chart with 3-sigma limits to monitor this process in the future.

The process average is computed as

$$\bar{\bar{x}} = \frac{50.09}{10} = 5.01$$

The control limits are

$$\begin{aligned} \text{UCL} &= \bar{\bar{x}} + z\sigma_{\bar{x}} \\ &= 5.01 + 3(.08/\sqrt{10}) \\ &= 5.09 \\ \text{LCL} &= \bar{\bar{x}} - z\sigma_{\bar{x}} \\ &= 5.01 - 3(.08/\sqrt{10}) \\ &= 4.93 \end{aligned}$$

None of the sample means ( $\bar{x}$ ) falls outside these control limits, which indicates that the

The process is in control and this is an accurate control chart.

**Range Chart**

The Goliath Tool Company from Examples wants to develop an R-chart to control process variability.

Subgroup	Observations(Slip Ring Diameter, cm),n					$\bar{x}$	R
	1	2	3	4	5		
1	5.02	5.01	4.94	4.99	4.96	4.984	0.08
2	5.01	5.03	5.07	4.95	4.96	5.004	0.12
3	4.99	5	4.93	4.92	4.99	4.966	0.08
4	5.03	4.91	5.01	4.98	4.89	4.964	0.14
5	4.95	4.92	5.03	5.05	5.01	4.992	0.13
6	4.97	5.06	5.06	4.96	5.03	5.016	0.1
7	5.05	5.01	5.1	4.96	4.99	5.022	0.14
8	5.09	5.1	5	4.99	5.08	5.052	0.11
9	5.14	5.1	4.99	5.08	5.09	5.08	0.15
10	5.01	4.98	5.08	5.07	4.99	5.026	0.1
						50.106	1.15

R is computed by first determining the range for each sample by computing the difference between the highest and lowest values as shown in the last column in our table of sample observations. These ranges are summed and then divided by the number of samples, k, as follows:

for n= 5, D3 =0 and D4 = 2.11

$$R = (\Sigma R) / k = 1.15 / 10 = 0.115$$

$$UCL = D_4 \bar{R} = 2.11(0.115) = 0.243$$

$$LCL = D_3 \bar{R} = 0(0.115) = 0$$

These limits define the R-chart shown in the following figure. It indicates that the process appears to be in control; any variability observed is a result of natural random occurrences

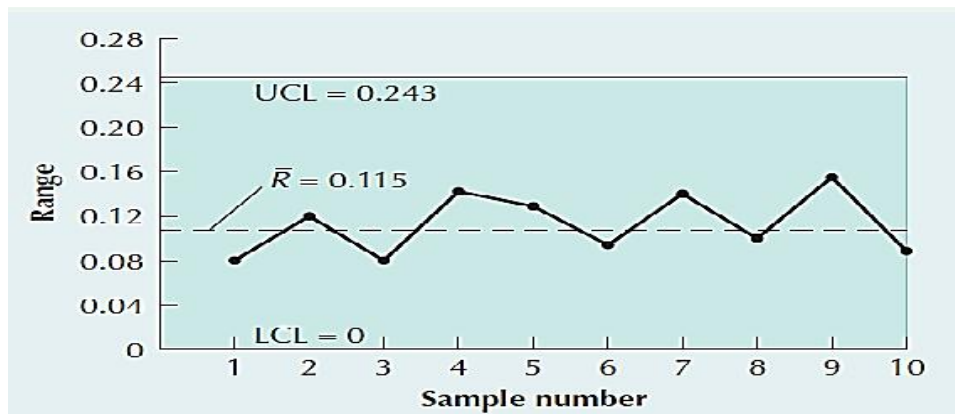

**Control Charts for Attributes**

P-charts and C-charts are two types of charts that will be used to represent qualities. Rather than measurements, this graph depicts quality qualities.

**P-CHART**

The quality feature is numbered rather than measured in a p-chart, and the entire item or service can be judged good or defective.

The proportion defective's standard deviation,  $p$ , is



**Example:** The Ritz Hotel has 240 rooms. The hotel's housekeeping department is responsible for maintaining the quality of the rooms' appearance and cleanliness. Each individual housekeeper is responsible for an area encompassing 20 rooms. Every room in use is thoroughly cleaned and its supplies, toiletries, and so on are restocked each day. Any defects that the housekeeping staff notice that is not part of the normal housekeeping service are supposed to be reported to hotel maintenance. Every room is briefly inspected each day by a housekeeping supervisor. However, hotel management also conducts inspection tours at random for a detailed, thorough inspection for quality-control purposes. The management inspectors not only check for normal housekeeping service defects like clean sheets, dust, room supplies, room literature, or towels, but also for defects like an inoperative or missing TV remote, poor TV picture quality or reception, defective lamps, a malfunctioning clock, tears or stains in the bedcovers or curtains, or a malfunctioning curtain pull. An inspection sample includes 12 rooms, that is, one room selected at random from each of the twelve 20-room blocks serviced by a housekeeper. Following are the results from 15 inspection samples conducted at random during a one-month period:

<b>Sample</b>	<b>Number of Defects</b>
<b>1</b>	<b>12</b>
<b>2</b>	<b>8</b>
<b>3</b>	<b>16</b>
<b>4</b>	<b>14</b>
<b>5</b>	<b>10</b>
<b>6</b>	<b>11</b>
<b>7</b>	<b>9</b>
<b>8</b>	<b>14</b>
<b>9</b>	<b>13</b>
<b>10</b>	<b>15</b>
<b>11</b>	<b>12</b>
<b>12</b>	<b>10</b>
<b>13</b>	<b>14</b>
<b>14</b>	<b>17</b>
<b>15</b>	<b>15</b>
	<b>190</b>

The hotel believes that approximately 99% of the defects (corresponding to 3-sigma limits) are caused by natural, random variations in the housekeeping and room maintenance service, with 1% caused by nonrandom variability. They want to construct a c-chart to monitor the housekeeping service.

Solution: - Because  $c$ , the population process average, is not known, the sample estimate,  $\bar{c}$ , can be used

Instead:

$$\bar{c} = 190/15 = 12.67$$

The control limits are computed using  $z = 3.00$ , as follows:

$$UCL = \bar{c} + z\sqrt{\bar{c}} = 12.67 + 3\sqrt{12.67} = 23.35$$

$$LCL = \bar{c} - z\sqrt{\bar{c}} = 12.67 - 3\sqrt{12.67} = 1.99$$

The resulting c-chart, with the sample points, is shown in the following figure:

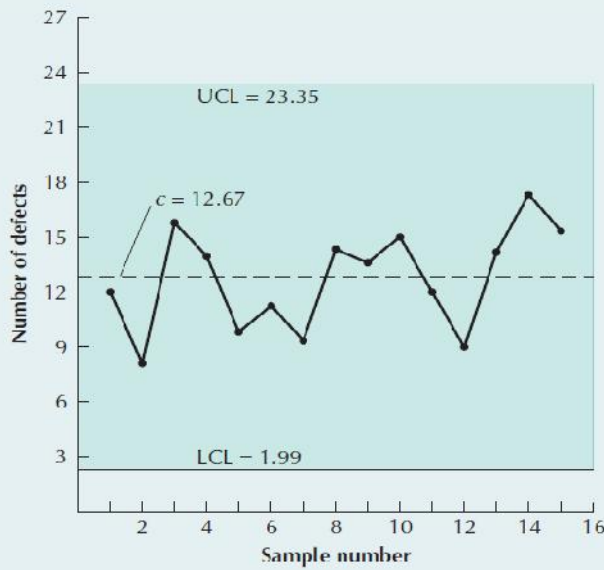

All the sample observations are within the control limits, suggesting that the room quality is in control. This chart would be considered reliable to monitor the room quality in the future.

P chart

The Western Jeans Company produces denim jeans. The company wants to establish a p-chart to monitor the production process and maintain high quality. Western believes that approximately 99.74% of the variability in the production process (corresponding to 3-sigma limits, or  $z = 3.00$ ) is random and thus should be within control limits, whereas 0.26% of the process variability is not random and suggests that the process is out of control. The company has taken 20 samples (one per day for 20 days), each containing 100 pairs of jeans ( $n = 100$ ), and inspected them for defects, the results of which are as follows.

Sample	Number of Defects	Proportion Defectives
1	6	0.06
2	0	0
3	4	0.04
4	10	0.1
5	6	0.06
6	4	0.04
7	12	0.12
8	10	0.1
9	8	0.08
10	10	0.1
11	12	0.12
12	10	0.1



13	14	0.14
14	8	0.08
15	6	0.06
16	16	0.16
17	12	0.12
18	14	0.14
19	20	0.2
20	18	0.18
	200	

The proportion defective for the population is not known. The company wants to construct a p-chart to determine when the production process might be out of control.

Solution Since p is not known, it can be estimated from the total sample:

$$\bar{p} = \frac{\text{total defectives}}{\text{total sample observations}}$$

$$\bar{p} = 200/20 * (100) = 0.10$$

The control limits are computed as follows:

$$\begin{aligned} \text{UCL} &= \bar{p} + z \sqrt{\frac{\bar{p}(1 - \bar{p})}{n}} \\ &= 0.10 + 3.00 \sqrt{\frac{0.10(1 - 0.10)}{100}} = 0.190 \\ \text{LCL} &= \bar{p} - z \sqrt{\frac{\bar{p}(1 - \bar{p})}{n}} \\ &= 0.10 - 3.00 \sqrt{\frac{0.10(1 - 0.10)}{100}} = 0.010 \end{aligned}$$

The p-chart, including sample points, is shown in the following figure:

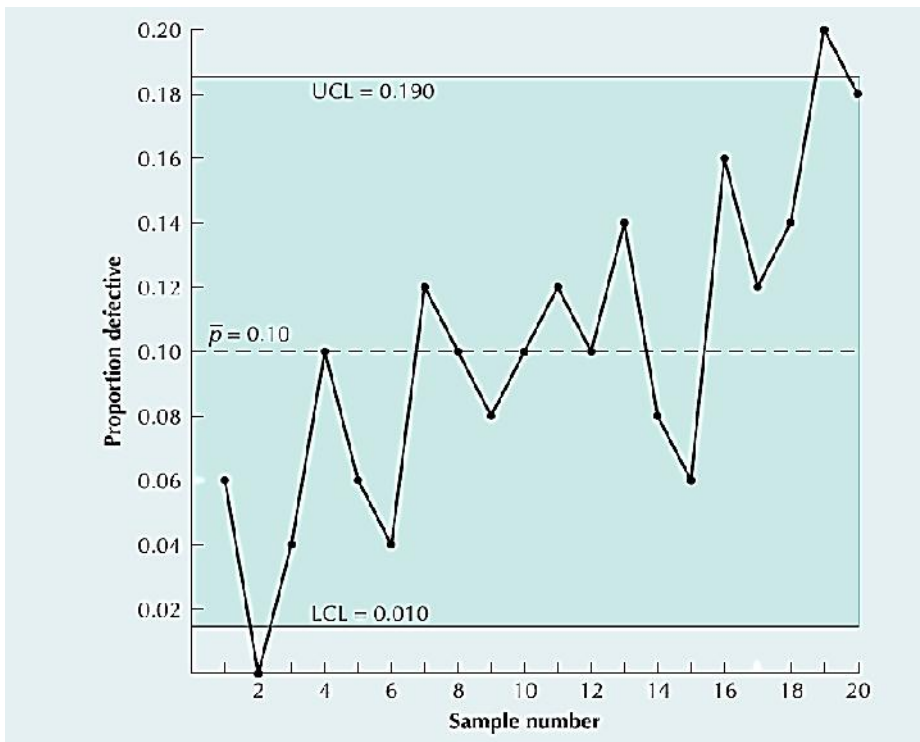

The process was below the lower control limits for sample 2 (i.e., during day 2). Although this could be perceived as a “good” result since it means there were very few defects, it might also suggest that something was wrong with the inspection process during that week that should be checked out. If there is no problem with the inspection process, then management would want to know what caused the quality of the process to improve. Perhaps “better” denim material from a new supplier that week or a different operator was working. The process was above the upper limit on day 19. This suggests that the process may not be in control and the cause should be investigated. The cause could be defective or maladjusted machinery, a problem with an operator, defective materials (i.e., denim cloth), or a number of other correctable problems. In fact, there is an upward trend in the number of defectives throughout the 20-day test period. The process was consistently moving toward an out-of-control situation. This trend represents a pattern in the observations, which suggests a non random cause. If this was the actual control chart used to monitor the process (and not the initial chart), it is likely this pattern would have indicated an out-of-control situation before day 19, which would have alerted the operator to make corrections.

$\sigma_p = \sqrt{\bar{p}(1-\bar{p})/n}$ , where  $n$  = sample size, and  $\bar{p}$  = average of several past  $p$  values and central line on the chart.

Using the normal approximation to the binomial distribution, which is the actual distribution of  $p$ ,

$$UCL_p = \bar{p} + Z\sigma_p$$

and

$$LCL_p = \bar{p} - Z\sigma_p$$

where  $z$  is the normal deviate (number of standard deviations from the average).

#### Run Chart:

A run chart is used to look for trends or patterns in data over a set period of time. A run chart will assist you in the following ways: Analyze data over time to look for patterns, shifts, or cycles. To determine the impact of a solution, compare a measure before and after it is implemented. Figure 5.8 is the example for Run Chart.

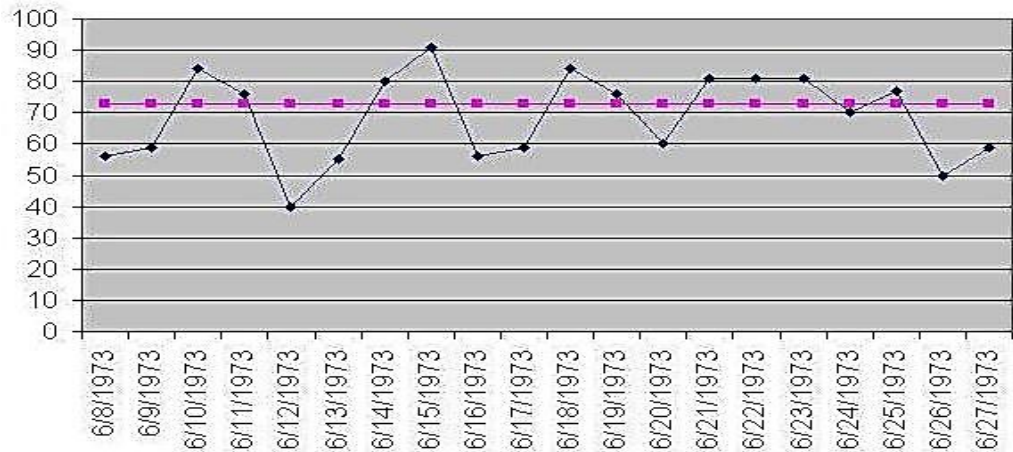

Figure 5.8 Run Chart

### Summary

- Because price and quality are the two most critical factors in every purchase, quality is incredibly crucial.
- Quality gurus have made significant contributions to the way businesses see the quality and accomplish it.
- Quality certification and awards are significant since they can provide customers with some assurance about the product's quality.
- There are numerous tools accessible for problem-solving and process optimization.

### Keywords

- **Statistical process control (SPC)** is a statistical procedure for monitoring the quality of the production process using control charts.
- A **control chart** is a graph that visually shows if a sample is within statistical limits for defective items.
- **Control limits** the upper and lower bands of a control chart.
- **Appraisal costs** of measuring, testing, and analyzing materials, parts, products, and the production process to make sure they conform to design specifications
- **Cause-and-effect diagram or fishbone diagram** is a graphical description of the elements of a specific quality problem.
- **Internal failure costs** of poor-quality products discovered during the production process – that is, scrap, rework, and the like.
- **External failure costs** of poor quality incurred after the product get to the customer; that is, customer service, lost sales, and so on

### Self Assessment

1. Rahul had booked a room in a 5-star hotel. After he checked in at his hotel room he was angry at finding that his bed sheet was filthy. Which dimension of 'service quality' was poorly reflected?
  - A. Tangibles
  - B. Reliability

- 
- C. Responsiveness  
D. Empathy
2. Which of the determinants of service quality involves performing the service right the first time?
- A. Access  
B. Courtesy  
C. Credibility  
D. Reliability
3. Which of the following is the primary characteristic of an electric kettle while referring to its 'performance'?
- A. It should boil water efficiently  
B. It should indicate the pouring temperature of the water  
C. It should be red in color  
D. It should be white in color
4. A team wants to illustrate which defect types are occurring most frequently. The quality tool they would use is a:
- A. Run Chart  
B. Pareto Chart  
C. Ishikawa Diagram  
D. Stratification
5. A team wants to illustrate which defect types are occurring most frequently. The quality tool they would use is a:
- A. Run Chart  
B. Pareto Chart  
C. Ishikawa Diagram  
D. Stratification
6. Which of the following gives an actual measurement of any specific dimension?
- A. Inspection by variables  
B. Inspection by attributes  
C. Both a. and b.  
D. None of the above
7. Match the following group 1 (charts) with group 2 (use) and select the correct option.
1. R chart ----- A. study the number of defects per unit  
2. C chart ----- B. size of the variable is studied  
3. P chart ----- C. dispersion of measured data  
4. X chart ----- D. defective units produced per subgroup

- A. 1 - A, 2 - B, 3 - D, 4 - C
  - B. 1 - C, 2 - D, 3 - B, 4 - A
  - C. 1 - A, 2 - D, 3 - B, 4 - C
  - D. 1 - C, 2 - A, 3 - D, 4 - B
8. Which of the following statements is/are true?
- 1. Trend type of control chart pattern shows the continuous movement of points upwards and downwards
  - 2. Trend pattern occurs due to change in the inspection method
  - 3. Downward trend indicates wear of parts
- A. Only 1
  - B. Only 2
  - C. Only 3
  - D. All of the above
9. The horizontal line in the control chart which shows the minimum value of a quality characteristic, before the process gets out-of-control, is called the \_\_\_\_\_
- A. Upper control limit
  - B. Lower control limit
  - C. Desired control limit
  - D. Center Line
10. If for a process, 18 out of 20 points are plotted above the CL but below the upper control limit, and only 2 of 20 are plotted between the center line and the lower control limit, what can we say about the process state?
- A. In-control
  - B. Out-of-control
  - C. Data is not enough to predict
  - D. Process state is not dependent on this data
11. If for a process, 18 out of 20 points are plotted above the CL but below the upper control limit, and only 2 of 20 are plotted between the center line and the lower control limit, what can we say about the process state?
- A. In-control
  - B. Out-of-control
  - C. Data is not enough to predict
  - D. Process state is not dependent on this data
12. Processes that operate with "six sigma quality" over the short term are assumed to produce long-term defect levels below \_\_\_\_\_ defects per million opportunities (DPMO).
- A. 2
  - B. 2.4
  - C. 3

D. 3.4

13. Inspection, scrap, and repair are examples of \_\_\_\_\_

- A. Internal costs
- B. External costs
- C. Costs of dissatisfaction
- D. Societal costs

14. All of the following costs are likely to decrease as a result of better quality except \_\_\_\_\_

- A. Customer dissatisfaction costs
- B. Inspection costs
- C. Maintenance costs
- D. Warranty and service costs

15. Kaizen is a \_\_\_\_\_ process, the purpose of which goes beyond simple productivity improvement.

- A. Weekly
- B. Daily
- C. Monthly
- D. Annual

### **Answers for Self Assessment**

1. A      2. D      3. A      4. A      5. B  
6. A      7. D      8. A      9. B      10. A  
11. A      12. D      13. A      14. C      15. B

### **Review Questions**

1. Explain the role of product and service quality in business strategy.
2. The traditional view of quality control is to have rigorous inspections to find and discard defectives so that only non defectives leave inspection. What is fundamentally wrong with this approach? Explain the meaning of this statement: "You cannot inspect quality into products."
3. Explain the meaning of this statement with example: "Quality drives the productivity machine."
4. What are the important elements of total quality management? Explain how each contributes to products and services of superior quality.
5. Discuss quality management in services. What factors make quality management more difficult in services than in manufacturing.

6. What quality management strategies have the service system devised to deal with the fact that services tend to be labor-intensive and geographically dispersed?
7. Explain the relationship between total quality management and quality control.
8. Discuss and evaluate this statement: "The time is fast approaching when there will be no place for acceptance plans in manufacturing."
9. What are Type I and Type II errors? How may we avoid or reduce these errors?
10. Answer these questions about inspection:
  - a. What level of inspection is optimal?
  - b. What factors guide the decision of how much to inspect?
  - c. What are the main considerations in choosing between centralized inspection and on-site inspection?
  - d. What points are potential candidates for inspection?



### **Further Readings**

- Operations Management By Norman Gaither, Cengage Learning
- Operations Management By Russell And Taylor, Wiley



### **Web Links**

- What is Statistical Process Control?- <https://asq.org/quality-resources/statistical-process-control>
- What is Total Quality Management (TQM)?- <https://asq.org/quality-resources/total-quality-management>

## Unit 06: Aggregate Production Planning

### CONTENTS

Objectives

Introduction

6.1 Concept of Aggregate planning

6.2 Master Production Schedule (MPS)

6.3 Material Requirement Planning

6.4 Material Requirement Planning -II

6.5 Enterprise Resource Planning

Summary

Keywords

Self Assessment

Answers for Self Assessment

Review Questions

Further Readings

### Objectives

After studying this unit, you will be able to:

- Understand the concept of aggregate planning and how it is used for effective production planning of a manufacturing organization.
- Get familiarity with the variables that can be considered in collective planning as well as for aggregate planning.
- Understand the concept of the master scheduling process, and material requirement planning that is frequently being used in effective production planning

### Introduction

Many sectors and public services, such as air conditioning, fuel, public utilities, police and fire protection, and travel, see seasonal changes in demand. These are only a few examples of industry and government agencies that must deal with unbalanced demand. In general, under these conditions, businesses cannot accurately estimate the quantity and timing of demand for certain items or services months in advance. Even so, to meet demand, they must typically estimate their capacity demands (e.g., labor, stocks) and expenses months in advance. How do they manage to do it? They employ a technique known as aggregate planning.

#### **6.1 Concept of Aggregate planning**

Aggregate planning, on the production planning spectrum, is intermediate-range capacity planning that normally covers a time horizon of 2 to 12 months, though it can stretch up to 18 months in some firms. It's especially valuable for businesses that have seasonal or other demand or capacity swings. Aggregate planning aims to produce a production plan that effectively utilizes the organization's resources to meet predicted demand. Output rates, employment levels, fluctuations, inventory levels and changes, backorders, and subcontracting in and out are all considerations that planners must make.



For intermediate-range planning, some firms use the term "sales and operations planning" rather than "aggregate planning." Sales and operations planning, on the other hand, is characterized as making intermediate-range decisions to balance supply and demand while also integrating financial and operational planning. Because the plan affects all functions of the company, it is usually created with input from sales (demand projections), finance (financial restrictions), and operations (operational constraints) (capacity constraints). It's worth noting that the sales and operations strategy is critical planning information that will affect the entire supply chain, and it should be shared with supply chain partners who may have relevant advice.

Long-term, intermediate-term, and short-term capacity decisions are made by organizations on three levels. Product and service selection (i.e., deciding which products or services to offer), facility size and location, equipment decisions, and facility layout are all long-term decisions. The capacity limitations within which intermediate planning must operate are fundamentally established by these long-term decisions. As previously stated, intermediate decisions are related to overall levels of employment, production, and inventories, which set the parameters within which short-term capacity decisions must be made. Short-term decisions are thus essentially decisions about the best way to attain desired goals within the limits imposed by long- and intermediate-term decisions. Scheduling jobs, workers, and equipment, among other things, are examples of short-term decisions.

Many businesses create a business plan that includes both long- and short-term planning. The business plan creates parameters for the company, taking into account the company's plans and objectives, demand estimates for the company's products or services, and economic, competitive, and political factors. The coordination of the intermediate plans of multiple organization activities, such as marketing, operations, and finance, is a primary goal of business planning. Engineering and materials management are also part of the coordinating process in manufacturing organizations. As a result, all of these functional areas must collaborate to create the overall strategy. Aggregate planning decisions are strategic decisions that establish the framework for making operational decisions. They serve as the foundation for scheduling and production management systems. They provide information for financial strategies, and they may necessitate adjustments in employment levels due to forecasts and demand management. If the company is in a time-based competition, it will be necessary to include some flexibility in the overall plan to respond to changing requirements quickly. Aggregate planning can also be used to inform other strategic decisions. For example, when aggregate planning alternatives for temporarily boosting capacity, such as working overtime or subcontracting, are too expensive, management may decide to enhance capacity.

**Concept of Aggregation:** Aggregate planning is a method of planning that takes a "big picture" approach. Unless the organization only has one significant product or service, planners strive to avoid focusing on specific products or services. Instead, they concentrate on a group of comparable items or services, or perhaps a complete product or service line. Planners in a television manufacturing company, for example, would not be concerned with 40-inch sets versus 46-inch or 55-inch sets. Instead, planners would combine all models and treat them as if they were a single product, thus the phrase aggregate planning. When fast-food corporations like McDonald's, Burger King, and Wendy's plan employment and output levels, they don't try to figure out how demand will be broken down into the numerous menu items they offer; instead, they concentrate on overall demand and the overall capacity they wish to give.

Consider how a huge department store might use aggregate planning. Space allocation is frequently a collective choice. For example, a manager might decide to devote 20% of the available clothes department space to women's sportswear and 30% to juniors, and so on, regardless of what brand names will be available or how many juniors will be wearing jeans. The total measure could be square feet of space or garment racks. For aggregate planning reasons, it's generally easier to think of capacity in terms of labour hours or machine hours per period, or production rates (barrels per period, units per period), rather than thinking about how much of a specific item will be involved. This method allows planners to make broad decisions about resource allocation without having to get bogged down in the details of each product or service requirement.

Why is it necessary for businesses to perform aggregation planning? There are two parts to the answer. One aspect has to do with planning: It takes time to put plans into action. For example, if employing (and training) additional employees are part of the plan, it will take time. The second section is tactical: Aggregation is critical because it is impossible to estimate the timing and volume of demand for individual items with any degree of accuracy. As a result, if a company "locks in" on

## *Unit 06: Aggregate Production Planning*

a single item, it loses its ability to respond to market changes. Aggregate planning is, in general, linked to the budgeting process. Most businesses anticipate their financial needs on a department-by-department basis every year. In aggregate planning, variations in demand information are treated as an important issue that requires additional attention.

**Concept of Variations:** Variations in supply or demand can arise in different areas of corporate management. Minor fluctuations are normally unaffected, but substantial variations have a significant influence on the capacity to match supply and demand, so they must be addressed. Rather than depending on a once-a-year projection, most businesses employ rolling 3-, 6-, 9-, and 12-month forecasts, which are updated regularly. This permits planners to adjust their plans in response to changes in either projected demand or expected supply. Some firms are more stable than others, and changes are more common in others. In such cases, a variety of measures are employed to counteract variances. One option is to keep a certain amount of surplus capacity on hand to deal with demand spikes. When the opportunity cost of lost revenue outweighs the cost of maintaining excess capacity, this technique makes sense. Maintaining a degree of flexibility in dealing with changes is another technique. This may entail recruiting temporary employees and/or working overtime as necessary. This method is commonly used by businesses that face seasonal needs.

The quantity and timing of predicted demand are of primary interest to aggregate planners. If the overall predicted demand for the planning period differs significantly from the existing capacity for the same period, planners will attempt to strike a balance by adjusting capacity, demand, or both. However, even if capacity and demand are roughly equal for the whole planning horizon, planners may still confront the challenge of dealing with irregular demand within the planning period. Expected demand may surpass planned capacity in some periods, be less than projected capacity in others, and be equal in others. Aggregate planners' goal is to achieve rough demand and capacity equality across the full planning horizon. Furthermore, although the cost is not the sole consideration, planners are usually concerned with minimizing the cost of the overall plan.

### **Strategies for Aggregate Planning:**

The production system's variables include labour, materials, and capital. To produce a bigger volume of output, more labour effort is necessary. As a result, the two relevant variables are employment and overtime (OT). Materials aid in the control of the output. Inventories, backorders, and item subcontracting are the options available to the company. These controllable variables are pure solutions for accommodating fluctuations in demand and uncertainty in industrial activities by following the steps below:

1. Vary the workforce size: Output is managed by hiring and firing personnel in response to changes in demand.
2. Vary working hours: Maintain a consistent staff, but provide the idle time when demand is low and overtime (OT) when demand is high.
3. Vary inventory levels: A big amount of inventory can be used to meet demand swings.
4. Subcontract: Demand has shifted upward from a low point. Subcontractors can be used to supply extra capacity to maintain consistent production rates.

Apart from these strategies, the guidelines for aggregate planning are as follows and can be used by production planners.

1. Determine the company's policy on controllable variables.
2. Plan with the help of a competent prediction.
3. Include the appropriate capacity units in your planning.
4. Maintain a consistent staff.
5. Maintain inventory management as appropriate.
6. Maintain a changeable mindset.
7. Act in a regulated manner in response to demand.
8. Review your plans frequently.

**Notes:**

- Good data is required for effective aggregate planning.
- First and foremost, the available resources during the planning period must be determined.
- Then there must be a projection of predicted demand.
- Finally, any policies relating to changes in employment levels must be considered by planners (e.g., some organizations view layoffs as extremely undesirable, so they would use that only as a last resort).
- Customers who make many bookings but only intend to maintain one or two of them sometimes place duplicate orders with companies in the travel industry and other industries.
- This complicates capacity planning even further.

## **6.2 Master Production Schedule (MPS)**

Aggregate planning is followed by master scheduling. It presents the overarching strategy in terms of distinct end products or models to which priority can be allocated. It's a good idea to plan for material and capacity needs. The type, volume, and component lead times of the items being produced determine the time interval employed in master scheduling. Normally, periods of one week are employed. The master schedule's time horizon is also influenced by product attributes and lead times. Some master schedules include as little as a few weeks, while others encompass more than a year.

The master schedule shows the amount and timing (i.e., delivery times) for a single product or a collection of items, but not scheduled production. A master schedule might, for example, ask for the delivery of 50 cases of cranberry-apple juice on May 1. However, there may be no need for manufacture because there are 200 cases in stock. It could also necessitate some production: If there were 40 cases in stock, an additional ten cases would be required to meet the delivery deadline. It could also entail the fabrication of 50 or more cases: In some cases, it is more cost-effective to create large quantities rather than tiny quantities, with the excess being stored in inventory until needed.

A tentative master schedule must be validated after it has been created. This is a critical step to take. Rough-cut capacity planning is the term used to describe validation (RCCP). It entails comparing the feasibility of a planned master schedule to available capacities to ensure that there are no visible capacity limits. This entails inspecting the capacities of production and warehouse facilities, as well as employees and vendors, to guarantee that there are no major flaws. There are several factors that will make the master timetable impossible. The master production schedule is then used to guide short-term planning. It's worth noting that, whereas the aggregate plan spans 12 months, the master timetable only covers a portion of it. In other words, the overall strategy is broken down into stages or phases that can last anywhere from a few weeks to two or three months. Furthermore, even though it spans two or three months, the master timetable can be changed periodically. For example, towards the end of January, the lawnmower master schedule would most likely be modified to reflect any changes in expected output for February and March, as well as new information on scheduled output for April.

### **Functions of Master Production Schedule:**

The Master Production Schedule (MPS) formally documents the production plan and turns it into material and capacity requirements. After then, the labor, material, and equipment requirements are evaluated. The diagrammatical representation of this has been shown in Figure 6.1.

### **The following are the primary roles of MPS:**

1. To break down broad plans into precise deliverables: The aggregate plan defines the level of operations that attempts to match market needs with the company's material, labor, and equipment capacities. This plan is translated into a particular number of end goods to be produced in a specific period by a master schedule.

### Unit 06: Aggregate Production Planning

2. Alternative schedules are evaluated: The master schedule is created by trial and error. To analyze the alternative schedules, a variety of computer simulation models are available.
3. Create a material requirement: This is the first step in the material requirement planning process (MRP).
4. Calculate capacity requirements: MPS is used to calculate capacity requirements. As a result, master scheduling is a requirement for capacity planning.
5. Control the load on the plant to make information processing easier. When the delivery is to be made is determined by the master timetable. It works in tandem with other management information systems including marketing, finance, and human resources.
6. Effective capacity use: The load and usage requirements for machinery and equipment are established by determining end item criteria.

Marketing, capacity planning, production planning, and distribution planning all interact with the master schedule: It allows marketers to make valid delivery commitments to warehouses and final customers; it allows production to assess capacity requirements; it gives production and marketing the information they need to negotiate when customer requests exceed normal capacity, and it allows senior management to assess whether the business plan and strategic objectives will be met.

The capacity employed for master scheduling is determined by aggregate planning decisions. There is a time lag between the creation of the aggregate plan and the creation of a master timetable. As a result, the outputs listed in a master schedule may differ from those displayed in the aggregate plan, simply because more current demand information may be available, which the master schedule would take into account.

A master scheduler is used (or should be used) by almost all manufacturing companies.

The master scheduler's responsibilities often include the following:

1. Evaluating the impact of new orders.
2. Providing order delivery dates.
3. Problem-solving:
  - a. assessing the impact of production delays or late deliveries of acquired items
  - b. When necessary, revise the master schedule due to insufficient supplies or capabilities.
  - c. Alerting production and marketing people to situations of insufficient capacity so that they can engage in dispute resolution.

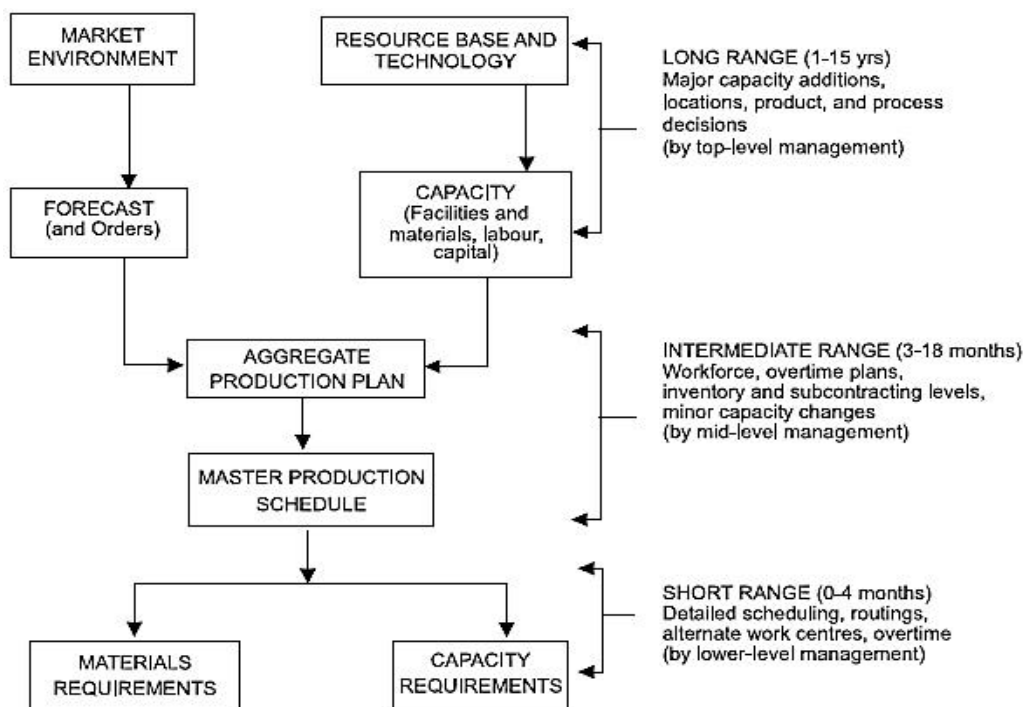

Figure 6.1 Master Production Schedule

### 6.3 Material Requirement Planning

The basic calculations used to identify components required from end item requirements are referred to as MRP. It also refers to a bigger information system that plans and controls manufacturing activities using the dependency connection.

"Materials Requirement Planning (MRP) is a method of determining the quantity and timing of dependent demand items required to meet the master production schedule's criteria."

Material requirements planning (MRP) is a computer-based information system that converts the master schedule's finished product requirements into time-phased requirements for subassemblies, component parts, and raw materials, working backward from the due date to determine when and how much to order. Thus, end-item needs create lower-level component requirements, which are broken down by planning periods (e.g., weeks) so that ordering, manufacturing, and assembly may be scheduled for timely completion of end items while inventory levels are kept low.

Material requirements planning is both a concept and a technique, as well as a scheduling and inventory control approach. Historically, there were two issues with ordering and scheduling assembled products. Setting up timetables, keeping track of large numbers of parts and components, and dealing with schedule and order changes were all huge tasks. The other problem was that there was no distinction between independent and dependent demand. Too often, order point systems and other approaches developed for independent-demand products were utilized to handle integrated commodities, resulting in enormous stockpiles. As a result, prior to the introduction of MRP, inventory planning and scheduling posed significant challenges for manufacturers.

MRP starts with a timetable for finished goods, which is then turned into a schedule of needs for the subassemblies, component components, and raw materials required to make the finished things in the time frame indicated.

As a result, MRP is built to answer three questions:

What exactly is required?

What is the exact amount required?

When is it required?

(1) A master production schedule, (2) an inventory status file, and (3) a bill of materials are the three inputs to the MRP system (BOM). The MRP processing logic (computer program) generates three types of information (output) for each product component based on these three data sources: order release requirements, order rescheduling, and scheduled orders.

**Master Production Schedule:** MPS is a set of time-phased quantities for each item a company produces, specifying how many and when they will be produced. Prior to the start of the MRP system, the MPS is created from firm customer orders or demand estimates. Whatever the master schedule requires, the MRP system turns MPS end items into particular component requirements. Many systems perform a simulated trial run to see if the intended master can be met.

**Inventory status file:** Every inventory item that is being planned requires an inventory status file that contains complete and up-to-date information on the item's on-hand quantities, gross requirements, scheduled receipts, and planned order releases. It also contains information on lot sizes, lead times, safety stock levels, and scrap allowances, among other things.

**Bill of materials:** The bill of materials (BOM) specifies how each final product is made, including all subcomponent items, their build-up sequence, the amount in each finished unit, and the work centers that perform the build-up sequence. This data comes from product design documentation, workflow analyses, and other industry-standard production data.

MRP systems have the capacity to give a wide range of outputs to management. Primary reports, which are the main outputs, and subsidiary reports, which are optional outputs, are commonly used classifications.

Production and inventory planning and control are part of primary reports. These reports normally include the following: 1. Planned orders, a schedule indicating the amount and timing of future orders. 2. Order releases, authorizing the execution of planned orders. 3. Changes to planned orders, including revisions of due dates or orders.

Additionally, MPS has the ability to produce secondary reports which are as below:

## Unit 06: Aggregate Production Planning

1. System performance is evaluated using performance-control reports. They help managers by detecting variations from plans, such as missed deliveries and stockouts, and by giving data that may be used to evaluate cost performance.
2. Planning reports are helpful for projecting future inventory needs. They contain purchase commitments as well as other information that can be utilized to forecast future material requirements.
3. Exception reports highlight serious inconsistencies such as late and delayed orders, high trash rates, reporting problems, and needs for nonexistent products. Users may generally adjust MRP to their specific needs because of the large choice of outputs.



### Notes:

- MRP has uses in both manufacturing and services.
- These applications may incorporate either material commodities that are part of the product-service bundle or primarily service components.
- A food catering service is an example of a product-service package, which is useful in situations where big groups of people need to be fed.
- The food manager would have to identify the quantities of ingredients for each item on the menu (i.e., a bill of materials), which would then be paired with the number of meals to be produced to obtain material requirements plan for the event.
- Similar examples can be found in large-scale renovations like a sports stadium or a major hotel, where several repetitions of activities and related materials must be "exploded" into their component parts for cost assessment and scheduling considerations.

## 6.4 Material Requirement Planning -II

MRP was created to help manufacturing organizations figure out exactly what resources they'd need to make a product, as well as when and how much they'd need them. Manufacturers identified additional demands in the 1980s, therefore manufacturing resources planning (MRP II) evolved from MRP. MRP II did not succeed in replacing or improving MRP. Rather, it broadened the scope of materials planning to include capacity requirements planning, as well as involving other organizational functional areas like marketing and finance in the planning process.

The planning of material requirements is at the heart of the procedure (see Figure 6.2). The procedure starts with a collection of demand from various sources (e.g., firm orders, forecasts, safety stock requirements). Personnel from production, marketing, and finance collaborate to create a master production schedule. Although production personnel will play a significant role in creating the schedule and in ensuring that it is followed, marketing and finance will also have significant contributions and responsibilities. The rationale for bringing these functional areas together is that it increases the chances of coming up with a plan that works and that everyone can live with. Finance resources, in addition to the obvious industrial resources required to support the strategy, will be required and must be planned for, both in terms of quantity and timing. Similarly, marketing resources will be required at various times along the process. The firm must have all of the necessary resources available as needed for the plan to work. An original plan is frequently altered when the availability of various resources is assessed. The master production schedule can then be finalized once they have been decided.

Material requirements planning kicks in at this step, and material and schedule requirements are generated. Following that, management must develop more specific capacity requirements determining whether or not these more particular capacity needs can be met. It's possible that the master production schedule will need to be adjusted once more.

As the timetable develops and actual work begins, a range of reports assists managers in keeping track of the process and making any required adjustments to keep things on track. In practice, this is an ongoing procedure in which the master production schedule is updated and amended as needed to meet company objectives.

Modifications to the business plan that guides the entire process are common, though they are less frequent than changes made at lower levels (i.e., the master production schedule).

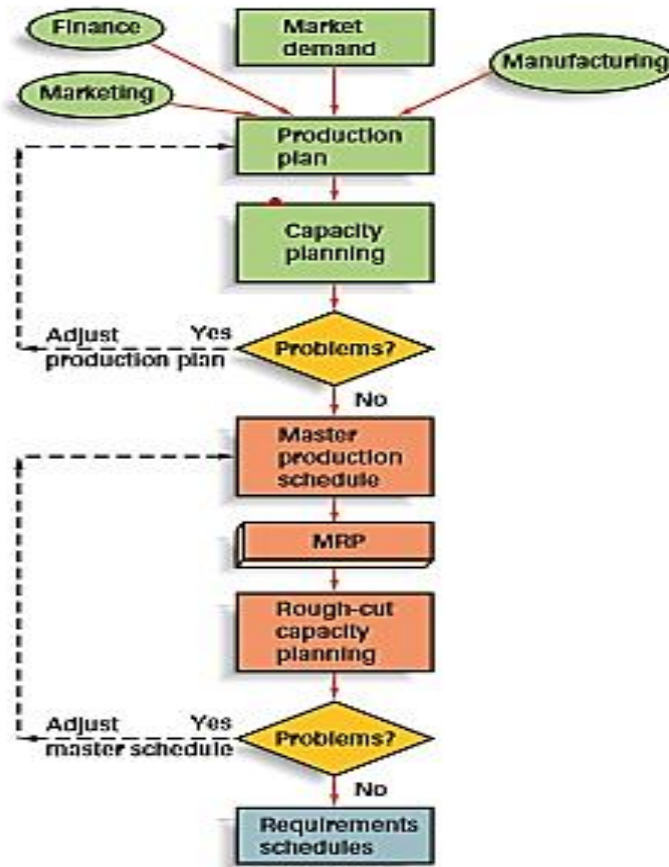

Figure 6.2: MRP II

### MRP in a closed-loop

MRP did not have the competence to analyze the viability of a given strategy when it was first introduced (i.e., if sufficient capacity existed at every level to achieve the plan). As a result, there was no means of knowing whether a suggested plan could be implemented or if it had been implemented before implementing it. As a result, each week a new plan had to be devised. Closed-loop MRP was coined when MRP II systems began to incorporate feedback loops. A suggested material plan is compared to available capacity in closed-loop MRP systems. A suggested plan must be amended if it is not possible. Capacity requirements planning is the name given to the review.

The practice of determining short-term capacity requirements is known as capacity requirements planning. Planned-order releases for MRP, the present shop load, routing information, and work times are all required inputs. Load reports for each work center are among the most important outputs. Managers may consider solutions such as alternative routings, altering or deleting lot sizing or safety stock requirements, and lot splitting when variations (under loads or overloads) are forecasted. Due to precedence requirements and component availability, moving to manufacture forward or backward might be extremely difficult.



#### Notes:

- Typically, a company creates a master timetable based on what is required, rather than what is feasible.
- When end products are converted into procurement, fabrication, and assembly needs, the initial timetable may or may not be achievable due to the limitations of the production system and the availability of materials.

- As a result, running a proposed master schedule via MRP processing to acquire a clearer image of actual requirements, which can then be compared to existing capacity and resources, is frequently necessary.
- Management may decide to enhance capacity (e.g., through overtime or subcontracting) or change the master schedule if it turns out that the current master timetable is not possible.

## 6.5 Enterprise Resource Planning

Business organizations are complicated systems in which multiple activities including purchasing, production, distribution, sales, human resources, finance, and accounting must collaborate to fulfill the organization's objectives. However, in many commercial organizations' functional structures, information flows freely inside each function but not between them. This makes transferring information between functional domains difficult.

Enterprise resource planning (ERP) was the next phase in a process that started with MRP and progressed to MRP II. It usually features an MRP core, just like MRP II. ERP refers to a broader endeavor to incorporate standardized record-keeping that will allow information to be shared among different areas of a company in order to better manage the system. ERP software is a system for capturing and making real-time data available to decision-makers and other users across an organization. It also comes with a suite of planning tools and keeps track of many business processes in order to fulfill the organization's objectives

ERP systems are made up of a number of interconnected modules. There are numerous modules to pick from, and different software suppliers provide lists of modules that are similar but not identical. Some are industry-specific, while others are more generic. The modules are divided into functional sectors of businesses. Accounting and finance, HR, product planning, purchasing, inventory management, distribution, order tracking, finance, accounting, and marketing are just a few of the modules available. Organizations can pick and choose which components best suit their needs and budgets.

### **ERP in Service Sector:**

ERP was originally designed for manufacturing, but it now includes a wide range of service applications. Professional services, postal services, retail, banking, health care, higher education, engineering and construction services, logistics services, and real estate management are examples of these industries.

ERP systems often cover major tasks in a manufacturing environment, such as production planning and scheduling, inventory management, product costing, and distribution. The key functions in a service environment can range from one service organization to the next. ERP systems, for example, are commonly used to integrate and access student information, course requirements, course schedules, room scheduling, human resources, accounting, and financial information at many universities. Patient records, prescription data, treatment plans, and scheduling information are all stored in hospital ERP systems (e.g., rooms, equipment, and surgery

## Summary

- MRP is a scheduling technique that uses fixed manufacturing lead times to build a timetable for all (dependent-demand) items in an end item's bill of materials.
- The bill of materials is used to deconstruct the final product, and material requirements plans are created to illustrate the quantity and timing for acquiring or creating components.
- The time-phasing of needs, computing component requirements, and planned-order releases are the primary features of MRP.
- MRP requires precise master production schedules, bills of materials, and inventory data to be successful.



- Firms that don't have adequately accurate records or timetables have had a hard time implementing MRP-style systems.
- The assumption of constant lead times is a potential flaw in MRP.
- MRP is used by the majority of MRP II and ERP systems.
- MRP II includes software applications for better managing the complete manufacturing process, including finance and marketing as well as capacity planning.
- ERP stands for Enterprise Resource Planning, and it is the third generation of manufacturing software that includes all business operations, including order entry and a financial management option that is integrated with the production processes offered in MRP II.

### **Keywords**

**Customer relationship management (CRM)** software that plans and executes business processes that involve customer interaction, such as sales, marketing, fulfillment, and customer service.

A **master production schedule (MPS)** is a schedule for the production of end items (usually final products). It drives the MRP process that schedules the production of component parts.

**Material requirements planning (MRP)** is a computerized inventory control and production planning system for generating purchase orders and work orders of materials, components, and assemblies.

**Enterprise resource planning (ERP)** software that organizes and manages a company's business processes by sharing information across functional areas.

**Capacity requirements planning (CRP)** is a computerized system that projects the load from a given material plan onto the capacity of a system and identifies underloads and overloads.

### **Self Assessment**

1. Advanced planning systems for aggregate planning rely heavily on \_\_\_\_\_ to deliver their full potential.
  - A. forecasting
  - B. constraints
  - C. data accuracy
  - D. the supply chain
  
2. Aggregate planning is concerned with determining
  - A. The production level, sales level, and capacity for each period.
  - B. The demand level, inventory level, and capacity for each period.
  - C. The production level, inventory level, and capacity for each period.
  - D. The production level, staffing level, and capacity for each period.
  
3. Dependence on an external source of supply is found in which of the following aggregate planning strategies?
  - A. varying production rates through overtime or idle time
  - B. using part-time workers
  - C. back-ordering during high demand periods
  - D. subcontracting

---

*Unit 06: Aggregate Production Planning*

4. PPC is called the nervous system of the organization because \_\_\_\_\_
- The dept indents materials through MRP.
  - It schedules each of the machines required for production
  - It takes care of the toolings
  - All information required for planning is received from all relevant departments.
5. XYZ is a tyre manufacturing company. The delivery of the tyres from the company has to be done to meet the market demands. Hence it is necessary to speed up the manufacturing process by facilitating extra resources to meet the deadlines. Which of these functions should the company implement?
- Expediting
  - Dispatching
  - Estimating
  - Scheduling
- Options 1 & 3
  - B Options 2 & 4
  - Options 1 & 2
  - Options 3 & 4
6. The correct sequence of operations in production planning and control is
- Routing-Scheduling-Dispatching-Follow up
  - Scheduling-Routing-Dispatching-Follow up
  - Dispatching-Routing-Scheduling-Follow up
  - Routing-Scheduling-Follow up-Dispatching
7. Material Requirement Planning MRP utilizes software applications for scheduling
- Sales management
  - Production processes.
  - marketing techniques
  - Human resource management.
8. In case of MTO items, the MRP systems save time by integrating with \_\_\_\_\_ systems
- Engineering change control
  - engineering change order
  - CAD and CAM
  - CAD
9. The \_\_\_\_\_ planning features of most MRP systems offer , both rough cut and detailed capacityplanning
- Capacity
  - Production
  - Marketing
  - test
10. MRP system is for\_\_\_\_\_

- A. major departments only
  - B. entire organization
  - C. marketing and sales
  - D. Operations department
11. What is the key to MRP
- A. Quantity of requirement for components are based upon the structure of the Bill of Material
  - B. Production of requirements for components is based upon the structure of the Bill of Material
  - C. Time phasing of a requirement for components is based upon the structure of the Bill of Material
  - D. The capacity of requirements for components is based upon the structure of the Bill of Material
12. Complete the sentence: MRP-II systems provide
- A. Information that is useful to all functional areas and encourages cross-functional interaction
  - B. Information with cost data.
  - C. Information that can be used for other company functions
  - D. Accurate inventory information
13. When the MRP system is introduced in a company, many employees find the transformation difficult to accept because of two reasons 1. The employees are not given proper training 2. Employees who are earlier doing the work of recording information are transformed into decision 3. Fear of unemployment 4. They fear that the system will revolutionize the way they live and work
- A. 1 & 2,
  - B. 3&4
  - C. 2 & 4
  - D. 1&3
14. The \_\_\_\_\_ is ( are) the MRP input detailing which items are to be produced, when they are needed and in what quantities
- A. Master production schedule
  - B. Gross requirements
  - C. Inventory records
  - D. Assembly time chart.
15. Aggregate planning solves problems involving
- A. Aggregate decisions or stock-keeping unit (SKU) level decisions.
  - B. Stock-keeping unit (SKU) level decisions rather than aggregate decisions.
  - C. Aggregate decisions rather than stock-keeping unit (SKU) level decisions.
  - D. Aggregate decisions and stock-keeping unit (SKU) level decisions.

**Answers for Self Assessment**

- |       |       |       |       |       |
|-------|-------|-------|-------|-------|
| 1. c  | 2. c  | 3. d  | 4. d  | 5. c  |
| 6. a  | 7. b  | 8. c  | 9. a  | 10. d |
| 11. c | 12. b | 13. d | 14. a | 15. c |

**Review Questions**

1. Explain how MRP could be applied to (a) the surgery suite of a hospital, (b) scheduling university classes, (c) a chain of restaurants, and (d) hotel renovations.
2. Describe the MRP process, including netting, explosion, lot sizing, and time phasing.
3. What are the inputs to capacity requirements planning? Discuss several alternatives for leveling the load on a facility.
4. Describe a production environment in which MRP would be useful. Describe a production environment in which MRP would not be useful.
5. Briefly define or explain each of these terms.
  - a. Master schedule.
  - b. Bill of materials.
  - c. Inventory records.
  - d. Gross requirements.
  - e. Net requirements.
  - f. Time-phased plan.
6. Describe the role of MPS, MRP, and CRP in resource requirements planning.
7. Briefly discuss the advantages and disadvantages of each of these planning strategies:
  - a. Maintain a level rate of output and let inventories absorb fluctuations in demand.
  - b. Vary the size of the workforce to correspond to predicted changes in demand requirements.
  - c. Maintain a constant workforce size, but vary hours worked to correspond to predicted demand requirements.
8. What aggregate planning difficulty that might confront an organization offering a variety of products and/or services would not confront an organization offering one or a few similar products or services?
9. Service operations often face more difficulty in planning than their manufacturing counterparts. However, service does have certain advantages that manufacturing often does not. Explain service planning difficulty, and the advantages and disadvantages.
10. What three levels of planning involve operations managers? What kinds of decisions are made at the various levels?

**Further Readings**

- Operations Management By Norman Gaither, Cengage Learning
- Operations Management By Russell And Tayllor, Wiley



### **Web Links**

- MRP-<https://www.techtarget.com/searcherp/definition/material-requirements-planning-MRP>
- What is aggregate planning- <https://www.managementstudyguide.com/aggregate-planning.htm>

## Unit 07: Inventory Management

### CONTENTS

Objectives

Introduction

7.1 Concept of Inventory

7.2 Inventory Counting Systems

7.3 Costs associated with Inventory

7.4 Inventory Control

7.5 Inventory Control Techniques

7.6 Inventory Control Deterministic Models

Summary

Keywords

Self Assessment

Answers for Self Assessment

Review Questions

Further Readings

### Objectives

After studying this unit, you will be able to:

- Understand the concept of inventory and how it is being used for executing operational activities of the production department.
- Get familiarity with the list of the main reasons for keeping inventory on hand, as well as the most important prerequisites for good inventory management.
- Understand the various popular inventory management techniques that are used for a sound inventory management system.

### Introduction

Inventory management is an important aspect of operations management. Most organizations and their supply chains rely on effective inventory management to operate successfully. Operations, marketing, and finance are all impacted by inventory management. Inventory management issues stymie operations, reduce customer satisfaction, and drive up operational expenses. Some businesses excel at inventory management, while others are content with what they have. Too many, on the other hand, have poor inventory management, which can be a sign that management doesn't understand the value of stockpiles. But, more often than not, the recognition is present. What's missing is a grasp of what needs to be done and how to go about doing it.

A stock or stockpile of items is referred to as inventory. Hundreds or even thousands of items, ranging from little goods like pencils, paper clips, screws, nuts, and bolts to major objects like machinery, trucks, construction equipment, and airplanes, are routinely kept in inventory by businesses. Many of the things in a company's inventory are, of course, tied to the type of business it does. Raw materials, purchased parts, partially finished objects, and finished goods, as well as spare parts for machines, tools, and other supplies, are all carried by manufacturing enterprises. Clothing, furniture, flooring, stationery, cosmetics, presents, cards, and toys are all sold in

department stores. Sporting goods, paints, and tools are also available in some stores. Drugs, surgical supplies, life-monitoring equipment, bedding and pillows, and other items are all kept on hand at hospitals.

## 7.1 Concept of Inventory

The materials in stock are referred to as inventory. It's also known as an organization's idle resource. Inventories are things that are either stocked for sale, are in the process of being manufactured, or are in the form of materials that have yet to be used. The period between acquiring purchased parts and transforming them into final goods varies by industry and is determined by the manufacturing cycle time. As a result, holding various types of inventories to function as a buffer between supply and demand is important for the system's efficient operation. As a result, excellent inventory control is required for the production cycle to function smoothly and efficiently with the fewest possible interruptions.

Inventory is one of the most critical components of any system that deals with the supply, manufacture, and distribution of goods and services. "Inventory refers to the number of raw materials or completed items on hand at any given time."

The term inventory can refer to a variety of things such as the stock of items on hand at any given moment; a detailed inventory of all physical assets; determining the quality of the objects in your possession, and the value of an organization's stock of commodities at a certain point in time.

Inventories are kept for a variety of reasons as described below.

1. *To maintain production stability:* Demand for a product fluctuates due to a variety of circumstances, such as seasonality, manufacturing schedule, and so on. Stocks (raw materials and components) should be made accessible to production as demand dictates, failing to do so results in stockouts and production halts due to a lack of materials. As a result, inventory is retained to account for this volatility and ensure that production runs smoothly.

2. *To avail advantage of price discounts:* Typically, manufacturers give discounts for bulk purchases, thus supplies are purchased in quantity even if they are not required right away. As a result, inventory is kept in order to save money on purchases.

3. *To satisfy demand during the replenishment period:* The lead time for material procurement is determined by a number of factors, including the source's location, demand-supply conditions, and so on. As a result, inventory is kept on hand during the procurement (replenishment) phase to meet demand.

4. *To avoid losing orders (sales):* In today's competitive environment, one must fulfill delivery schedules at a 100% service level, which means they cannot afford to miss a delivery schedule, which could result in a loss of sales. To avoid this, businesses must keep track of their inventories.

5. *Adapt to changing market conditions:* Businesses must anticipate shifting market sentiments and stock materials in case of material shortages or price increases.

6. Organizations are sometimes forced to stock materials owing to other factors such as a supplier's minimum quantity need, seasonal availability of materials, or a price increase.



### **Notes:**

- Inventory selections in service businesses are very important.
- For example, hospitals stock a variety of medications and blood supplies that may be required on short notice.
- Some of these may be out of stock, putting a patient's health at risk.
- However, because many of these materials have a short shelf life, hauling significant numbers would require disposing of old and expensive supplies.
- On-site computer, printer, copier, and fax machine repair services must also carefully select which parts to bring to the site in order to prevent making an additional journey to collect parts.

- Home repair providers such as electricians, appliance repairers, and plumbers are in the same boat.

## 7.2 Inventory Counting Systems

For effective inventory management, periodic or perpetual inventory counting systems are available. In a periodic system, a physical count of inventory items is performed at regular intervals (e.g., weekly, monthly) to determine how much of each item is to order. This strategy is used by a lot of small businesses: A manager examines the shelves and stockroom on a regular basis to ascertain the quantity on hand. The manager then calculates how much will be needed before the next delivery period and bases the order quantity on that calculation. This type of system has the advantage of allowing orders for many items to be placed at the same time, resulting in cost savings in order processing and shipping. Periodic reviews also have a number of drawbacks. One is a lack of control over evaluations between them. Another consideration is the requirement to keep sufficient stock on hand to avoid shortages between review periods.

A perpetual inventory system (also known as a continual system) keeps track of inventory removals on a continuous basis so that the system may provide information on the current inventory level for each item. When the amount on hand falls below a certain threshold, a fixed quantity,  $Q$ , is ordered. The control afforded by the constant monitoring of inventory withdrawals is an evident benefit of this approach. Another benefit is the fixed-order quantity, which allows management to decide the best order quantity. The additional cost of record-keeping is one downside of this strategy.

Furthermore, because of possible errors, pilferage, spoiling, and other variables that can diminish the effective amount of inventory, a physical count of stocks must be undertaken on a regular basis to check records. Continuous inventory changes are documented by bank activities such as client deposits and withdrawals.

Perpetual systems are available in a variety of configurations, from the most basic to the most complex. Two containers are used for inventory in a two-bin system, which is a fairly basic system. The first bin's contents are depleted before items are removed. After then, it's time to restock. An order card is sometimes placed at the bottom of the first bin. The second bin includes enough stock to meet predicted demand until the order is filled, as well as a buffer of stock to prevent a stockout if the order is late or usage exceeds expectations. The benefit of this technique is that each withdrawal from inventory does not need to be recorded. The drawback is that for a variety of reasons, the reorder card may not be returned (e.g., misplaced, the person responsible forgets to turn it in).

Periodic counting systems have long been popular in supermarkets, discount retailers, and department stores. Most stores now use computerized checkout systems that read a universal product code (UPC) or bar code written on an item tag or packaging with a laser scanning device. Here's an example of a typical supermarket product code:



The zero on the left indicates that this is a supermarket item, the first five numbers (14800) identify the manufacturer (Mott's), and the last five numbers (23208) indicate the exact item (natural-style applesauce). A six-digit number is used on tiny packaging items like sweets and gum.

Electronic point-of-sale (POS) systems keep track of actual sales. Actual sales data can substantially help with forecasting and inventory management: These technologies enable management to make any necessary changes to restocking decisions by sending information about actual demand in real-



time. By making this information available to suppliers, these systems are increasingly being emphasized as a vital input to good supply chain management. Supermarkets profit greatly from UPC scanners. These systems, in addition to increasing speed and accuracy, provide managers with continuous inventory information, reduce the need for periodic review and order-size determinations, and improve customer service by indicating the price and quantity of each item on the customer's receipt.

Apart from retail, bar-coding is used in a variety of industries. The simplified production and inventory control it provides is beneficial to both manufacturing and service businesses. Bar codes applied to parts, subassemblies, and final goods considerably simplify counting and monitoring tasks in manufacturing. Bar codes can also be used for automatic routing, scheduling, sorting, and packaging. Bar codes can assist reduce medicine delivery errors in health care. In some applications, radio frequency identification (RFID) tags are also utilized to maintain track of inventory.

### **7.3 Costs associated with Inventory**

Purchase, holding, transaction (ordering), and scarcity costs are the four primary expenses connected with inventories. The amount paid to a vendor or supplier to purchase inventory is referred to as the purchase cost. It is usually the most expensive of all inventory charges. The costs of holding or carrying, objects in storage are related to the actual storage of those items. Interest, insurance, taxes (in some states), depreciation, obsolescence, deterioration, spoiling, pilferage, breakage, tracking, picking, and warehousing charges are all factors that must be considered (heat, light, rent, security). They also include the potential costs of having monies that may be put to better use elsewhere stranded in inventory. It's worth noting that the variable element of these costs is the one that matters.

Although taxes, interest, and insurance are generally predicated on the cash worth of an inventory, the significance of the various components of holding cost varies depending on the type of item involved. Items that are easy to conceal (e.g., pocket cameras, transistor radios, calculators) or somewhat valuable (cars, televisions) are more likely to be stolen. Fresh seafood, meats and poultry, fruit, and baked items deteriorate quickly and spoil easily. Shelf life is also limited to dairy goods, salad dressings, pharmaceuticals, batteries, and film. Holding costs are expressed as a percentage of unit pricing or as a dollar sum per unit in one of two ways. Annual holding expenses for most items range from 20% to 40% or more of the item's worth. To put it another way, keeping a \$100 item in inventory for a year could cost anything from \$20 to \$40.

The costs of purchasing and receiving inventories are known as ordering costs. They are the costs that change depending on when an order is placed. They involve, among other things, determining how much is needed, creating invoices, evaluating items for quality and quantity upon delivery, and transporting commodities to temporary storage. Regardless of order size, ordering costs are usually presented as a fixed dollar sum per order. Machine setup costs (e.g., preparing equipment for the job by adjusting the machine, changing cutting tools) are analogous to ordering costs when a company produces its own inventory rather than ordering it from a supplier.

When demand exceeds the availability of inventory on hand, shortage costs arise. The opportunity cost of not making a sale, as well as the loss of client goodwill, are examples of these expenses, late fees, backorder fees, and other comparable fees. Furthermore, the cost of missed output or downtime is considered a shortage cost if the shortfall occurs in an item transported for internal use (e.g., to supply an assembly line). Costs of this nature can quickly reach hundreds of dollars per minute or more. Shortage costs can be difficult to quantify, and they may have to be evaluated subjectively.

### **7.4 Inventory Control**

Inventory control is a method of selecting what to get when to order it, how much to order, and how much to stock so that buying and storing costs are minimized while production and sales are not disrupted. Inventory management primarily addresses two issues: When should an order be placed? (Amount to order) and (ii) How much should be ordered? (Place a quantity order.) Inventory models are used to answer these problems.

The scientific inventory control system finds a balance between the loss incurred as a result of an item's non-availability and the expense of maintaining an item's stock. Scientific inventory control

seeks to keep the company's essential commodities in the best possible condition at the lowest possible cost.

### Objectives of Inventory Control

1. To assure enough product supply to customers while avoiding shortages as much as feasible.
2. Ensure that the financial investment in inventories is as little as feasible (i.e., to see that the working capital is blocked to the minimum possible extent).
3. Purchasing, storing, using, and accounting for goods efficiently is a key goal.
4. To keep a timely record of all item inventories and to keep the stock within the required limits.
5. To guarantee that replenishment is done in a timely manner.
6. Maintain a reserve stock to account for fluctuations in material supply lead times.
7. To provide a scientific foundation for both short- and long-term material planning.

It is a well-known fact that the following benefits of inventory control can be obtained through the use of scientific inventory control:

1. Better customer relations as a result of on-time delivery of goods and services.
2. Consistent and smooth production, resulting in no stock out.
3. Effective working capital management.Reduces the amount of money lost owing to deterioration, obsolescence, and pilferage.
4. Purchase cost-cutting.
5. Removes the possibility of ordering twice.

## 7.5 Inventory Control Techniques

Inventory is kept in any company, depending on the type of business. When an inventory has a big number of goods and a large amount of money is required to develop it, management is concerned about maintaining adequate control over its ordering, procurement, maintenance, and consumption. Order quality and frequency can both be controlled.

(1) ABC analysis, (2) HML analysis, (3) VED analysis, (4) FSN analysis, (5) SDE analysis, (6) GOLF analysis, and (7) SOS analysis are the many inventory control approaches.

ABC analysis is the most extensively utilised approach of inventory control.The overall inventory is divided into three sub-heads in this method, and each sub-head is then exercised properly.

1. **ABC analysis:** Existing inventory is classified based on annual consumption and the annual value of the products in this analysis. As a result, we calculate yearly consumption costs by multiplying the number of inventory items consumed over the course of the year by the unit cost. The elements are then sorted by annual consumption cost in descending order.

The study is done by creating a graph based on the total number of items and the total cost of consumption.The following description will define how classification has to be done:

<i>Category</i>	<i>Percentage of items</i>	<i>Percentage of annual consumption value</i>
A	10–20	70–80
B	20–30	10–25
C	60–70	5–15

*The graphical explanation of this above ABC classification is given below in figure 6.1*

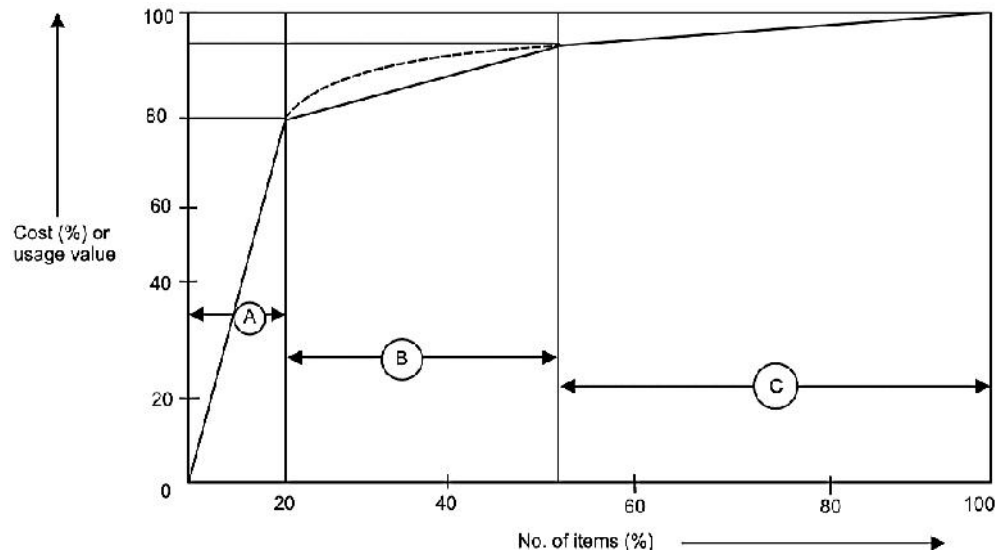

Figure 6.1: ABC Classification

Following the ABC classification, the policy control can be written as follows:

A-Item: Extremely strict control due to the high worth of the items. The control must be exercised at a higher authority level.

B-Item: Moderate control, with moderately valuable objects. The control must be exercised at the intermediate level of authority.

C-Item: Due to the low value of the items, control can be exercised at the grass-root level of authority, i.e. by the appropriate user department manager

2. **HML analysis:** In this analysis, existing inventory is classified based on the item's unit price.

They are divided into three categories: high-cost, medium-cost, and low-cost items.

3. **VED analysis:** In this analysis, existing inventory is classified according to the criticality of the products. They are divided into three categories: vital, essential, and desired. It is mostly utilized in the inventory of spare components.

4. **FSN analysis:** In this study, existing inventory is classified depending on item consumption. They are divided into three categories: those that move quickly, those that move slowly, and those that do not move at all.

5. **SDE analysis:** In this analysis, existing inventory is classified depending on the items.

6. **GOLF analysis:** In this analysis, existing inventory is classified based on the items' sources. They are divided into four categories: government supply, normally available, locally available, and international source of supply.

7. **SOS analysis:** In this analysis, existing inventory is classified based on the type of the supply of commodities. They are divided into two categories: seasonal and non-seasonal products.

A combination of ABC with VED, ABC with HML, or VED with HML analysis is commonly utilized for successful inventory control.

## 7.6 Inventory Control Deterministic Models

When demand is mainly unknown, deterministic inventory control models are used to calculate the best inventory of a single item. EOQ is one of the model popular models in this category.

**Economic Order Quantity Models:** Men, machines, money, and materials are all idle resources in inventory models. These models are concerned with two decisions: how much to order (buy or make) and when to order in order to reduce total cost. Two basic expenses are assessed for the first decision—how much to order—inventory carrying costs and ordering or acquisition costs. The inventory carrying cost rises as the quantity ordered rises, but the ordering cost falls. The quantity produced or procured during one manufacturing cycle is referred to as the 'order quantity.' By balancing the two costs, the economic order quantity is calculated. The Economic Order Quantity

(EOQ) is the order quantity that minimizes overall carrying and ordering costs. i.e., when Inventory Carrying Cost = Ordering Cost, Minimum Total Cost happens.

The following are three order size models:

1. The economic order quantity model in its most basic form.
2. The quantity model of economic production(Production Model)
3. The third model is the quantity discount model.

**Basic Model:**The simplest of the three types is the basic EOQ model. It is used to determine a fixed order size that will reduce the total annual expenditures of inventory holding and ordering. The unit purchase price of inventory items is usually not included in the overall cost because the unit cost is unchanged by order size unless quantity discounts are taken into account. When holding costs are expressed as a percentage of unit cost, the unit cost is included in the overall cost as part of holding costs.

#### Assumptions of Model:

1. There is only one product involved.
2. Demand requirements for the year are known.
3. Demand is distributed uniformly throughout the year, resulting in a generally stable demand rate.
4. The lead time is predictable and consistent.
5. Each order is delivered in one package.
6. There are no savings for purchasing in bulk.

Ordering and using inventory happens in cycles. Several inventory cycles are depicted in Figure 7.2a cycle begins with the receipt of an order of  $Q$  units, which are gradually removed at a steady rate. An order for  $Q$  units is placed with the supplier when the quantity on hand is just enough to meet demand during the lead period. Because both the usage rate and the lead time are expected to be constant, the order will be received at the same moment that the inventory on hand reaches zero.

As a result, orders are placed at specific times to avoid both excess stock and stock outs. The ideal order quantity is determined by a balance of carrying and ordering costs: One form of the cost will increase when order size changes, while the other will drop. If the typical order size is small, for example, the average inventory will be low, resulting in reduced carrying costs.

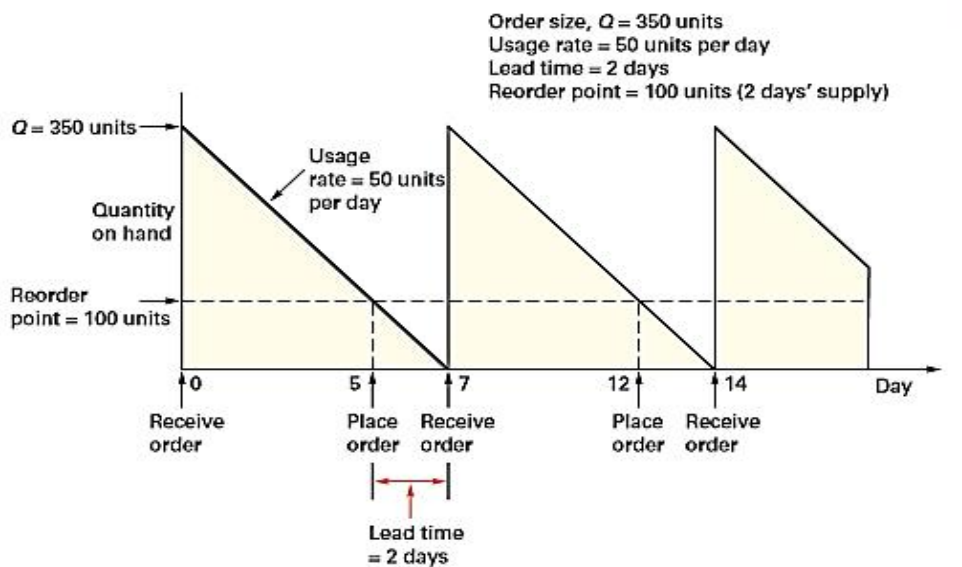

Figure 7.2: Inventory cycles

A modest order quantity, on the other hand, will need frequent orders, which will raise annual ordering costs. Ordering big quantities at rare intervals, on the other hand, can reduce annual

ordering costs, but it will result in greater average inventory levels and thus higher carrying costs. These two extremes are depicted in Figure 7.3. As a result, the optimal order size is one that produces neither a few large orders nor a huge number of tiny orders, but one that falls somewhere in the middle. The precise amount to order will be determined by the magnitudes of the carrying and order charges.

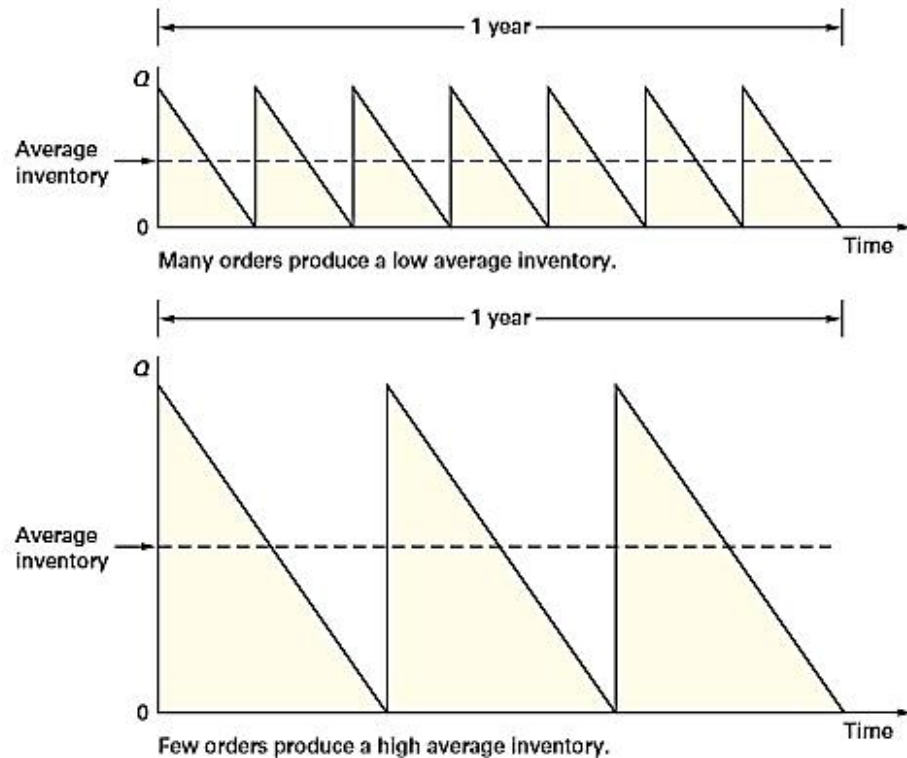

Figure 7.3: The number of orders per year and the average inventory level are inversely related:

As one grows, the other shrinks.

As a result, the optimal order size is one that produces neither a few large orders nor a huge number of tiny orders, but one that falls somewhere in the middle. The precise amount to order will be determined by the magnitudes of the carrying and order charges.

Annual carrying cost is calculated by multiplying the average amount of inventory on hand by the cost of carrying one unit for a year, even if each unit is not held for a year. The average quantity of inventory is half of the order quantity: The amount on hand constantly drops from  $Q$  units to 0, resulting in an average of  $(Q + 0)/2$ , or  $Q/2$ . The total yearly carrying cost is calculated using the symbol  $H$  to denote the average annual carrying cost per unit.

$$\text{Annual carrying cost} = \frac{Q}{2} H$$

where

$Q$  = Order quantity in units

$H$  = Holding (carrying) cost per unit per year

As shown in Figure 7.4 A, carrying costs are a linear function of  $Q$ : they increase or decrease in direct proportion to changes in order quantity  $Q$ . Annual ordering costs, on the other hand, will drop as order size grows since, for a given annual demand, the larger the order size, the fewer orders are required.

For example, if the annual demand is 12,000 units and orders are 1,000 units each, there must be 12 orders placed throughout the year. However, if  $Q = 2,000$  units are required, only six orders are required; if  $Q = 3,000$  units are required, only four orders are required. In general, the annual order volume will be  $D/Q$ , where  $D$  is the annual demand and  $Q$  is the quantity demanded. Size of the order.

Unlike carrying costs, ordering expenses are essentially unaffected by order size; regardless of the size of an order, certain actions must be completed, such as determining how much is required, monitoring sources of supply on a regular basis, and creating invoices.

Even shipment inspection, which verifies quality and quantity characteristics, is unaffected by order size because large shipments are sampled rather than thoroughly inspected. As a result, the cost of the order is viewed as a constant. The annual ordering cost is calculated by multiplying the number of orders per year by the ordering cost per order:

$$\text{Annual ordering cost} = \frac{D}{Q} S$$

where

$D$  = Demand, usually in units per year

$S$  = Ordering cost per order

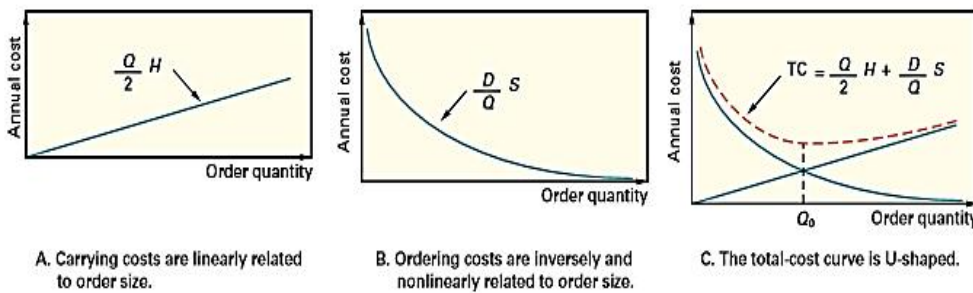

Figure 7.4: Graphical representation of costs related to EOQ

Annual ordering cost is inversely related to order size, as shown in Figure 7.4 B, because the number of orders each year,  $D/Q$ , reduces as  $Q$  grows. When  $Q$  units are ordered each time, the total annual cost (TC) of carrying and ordering inventory is

$$\text{TC} = \frac{\text{Annual carrying cost}}{\text{cost}} + \frac{\text{Annual ordering cost}}{\text{cost}} = \frac{Q}{2} H + \frac{D}{Q} S$$

..... 7.1

(Note that  $D$  and  $H$  must be expressed in the same units, such as months and years.) The total cost curve is U-shaped (i.e., convex, with one minimum) and achieves its minimum at the quantity when carrying and ordering costs are identical, as shown in Figure 7.4 C. Calculus can be used to find an expression for the optimal order quantity,  $Q$  as given below in the formula.

$$Q_0 = \sqrt{\frac{2DS}{H}}$$

.....7.2

Given annual demand, ordering cost per order, and annual carrying cost per unit, the best (economic) order quantity can be calculated. By swapping  $Q_0$  for  $Q$  in the Formula of the total cost as given in equation 7.1, the lowest overall cost is found. An order cycle's length (i.e., the time between orders) is

$$\text{Length of order cycle} = \frac{Q}{D}$$

.....7.3

**Numerical**

The ePaint Store stocks paint in its warehouse and sell it online on its Internet Web site. The store stocks several brands of paint; however, its biggest seller is Sharman-Wilson Ironcoat paint. The company wants to determine the optimal order size and total inventory cost for Ironcoat paint given an estimated annual demand of 10,000 gallons of paint, an annual carrying cost of \$0.75 per

gallon, and an ordering cost of \$150 per order. They would also like to know the number of orders that will be made annually and the time between orders (i.e., the order cycle).

$$C_c = \$0.75 \text{ per gallon}$$

$$C_o = \$150$$

$$D = 10,000 \text{ gallons}$$

The optimal order size is

$$\begin{aligned} Q_{\text{opt}} &= \sqrt{\frac{2C_o D}{C_c}} \\ &= \sqrt{\frac{2(150)(10,000)}{(0.75)}} \\ &= 2000 \text{ gallons} \end{aligned}$$

Solution

The total annual inventory cost is determined by substituting  $Q_{\text{opt}}$  into the total cost formula:

$$\begin{aligned} \text{TC}_{\text{min}} &= \frac{C_o D}{Q_{\text{opt}}} + \frac{C_c Q_{\text{opt}}}{2} \\ &= \frac{(150)(10,000)}{2000} + \frac{(0.75)(2000)}{2} \\ &= \$750 + 750 \\ &= \$1500 \end{aligned}$$

The number of orders per year is computed as follows:

$$\begin{aligned} \text{Number of orders per year} &= \frac{D}{Q_{\text{opt}}} \\ &= \frac{10,000}{2000} \\ &= 5 \text{ orders per year} \end{aligned}$$

Given that the company processes orders 311 days annually (365 days minus 52 Sundays, Thanksgiving, and Christmas), the order cycle is

$$\begin{aligned} \text{Order cycle time} &= \frac{311 \text{ days}}{D/Q_{\text{opt}}} \\ &= \frac{311}{5} \\ &= 62.2 \text{ days} \end{aligned}$$

**Production Model:** Batch mode is commonly used in manufacturing. Parts of the work are done in batches even in assembly procedures. The reason for this is that in some cases, the ability to make a part exceeds the pace at which the part is used or demanded. Order will continue to be fulfilled as long as production continues and The stockpile will continue to expand. Instead of producing continuously, it makes sense to produce such things in batches, or lots, on a regular basis.

The EPQ model's assumptions are identical to those of the EOQ model, with the exception that instead of receiving orders in a single delivery, units are delivered progressively during production.

The assumptions are as follows:

1. There is just one item involved.
2. The demand for each year is known.
3. The rate of utilization remains constant.
4. Usage happens all the time, but production happens only once in a while.
5. The rate of output remains constant.
6. There is no variation in lead time.
7. There are no savings for purchasing in bulk.

Figure 7.5 shows how making a batch of a certain item on a regular basis affects inventory. Inventory builds up at a rate equal to the difference between production and utilization rates throughout the production phase of the cycle. If the daily production rate is 20 units and the daily usage rate is 5 units, inventory will accumulate at a rate of 15 units every day. The inventory level will continue to rise as long as manufacturing continues; if production stops, the inventory level will begin to decline. As a result, when manufacturing stops, the inventory level will be at its highest. When the available inventory is depleted, production resumes, and the cycle begins again.

There are no ordering charges because the company manufactures the product. Nonetheless, there are setup expenses associated with each production run (batch), which are the expenditures associated with preparing the equipment for the operation, such as cleaning, adjusting, and replacing tools and fixtures. Setup costs are similar to ordering expenses in that they are unaffected by the size of the lot (run). They're both treated the same way in the formula. The higher the run size, the fewer runs are required, and so the annual setup cost is reduced. The yearly setup cost is equal to the number of runs or batches each year times the setup cost,  $S$ , per run:  $(D/Q)S$ .

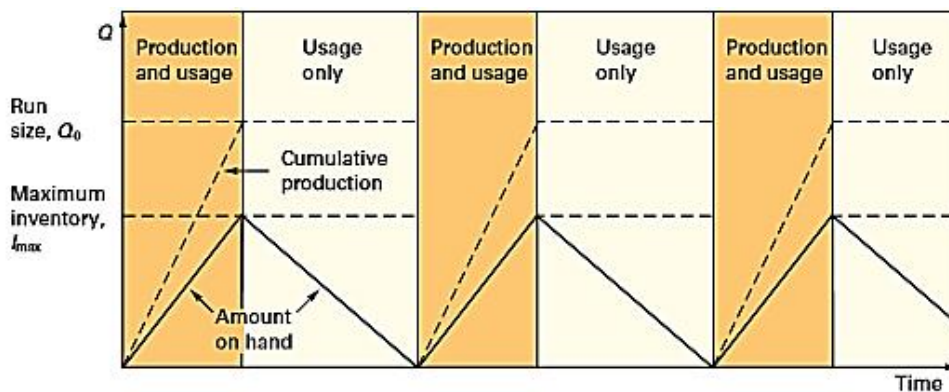

Figure 7.5: EOQ with incremental inventory buildup

The total cost is

$$TC_{\min} = \text{Carrying cost} + \text{Setup cost} = \left( \frac{I_{\max}}{2} \right) H + (D/Q)S$$

where

$$I_{\max} = \text{Maximum inventory}$$

The economic run quantity is

$$Q_p = \sqrt{\frac{2DS}{H}} \sqrt{\frac{p}{p-u}}$$

where

$p$  = Production or delivery rate

$u$  = Usage rate

Numerical



Assume that the ePaint Store has its own manufacturing facility in which it produces Ironcoat paint. The ordering cost,  $C_o$ , is the cost of setting up the production process to make paint.  $C_o = \$150$ . Recall that  $C_c = \$0.75$  per gallon and  $D = 10,000$  gallons per year. The manufacturing facility operates the same days the store is open (i.e., 311 days) and produces 150 gallons of paint per day. Determine the optimal order size, total inventory cost, the length of time to receive an order, the number of orders per year, and the maximum inventory level.

Number of orders per year, and the maximum inventory level.

### Solution

$$C_o = \$150$$

$$C_c = \$0.75 \text{ per gallons}$$

$$D = 10,000 \text{ gallons}$$

$$d = \frac{10,000}{311} = 32.2 \text{ gallons per day}$$

$$p = 150 \text{ gallons per day}$$

The optimal order size is determined as follows:

$$Q_{\text{opt}} = \sqrt{\frac{2C_oD}{C_c\left(1 - \frac{d}{p}\right)}}$$

$$= \sqrt{\frac{2(150)(10,000)}{0.75\left(1 - \frac{32.2}{150}\right)}}$$

$$= 2256.8 \text{ gallons}$$

Although an order of 2256.8 gallons should be rounded to 2257, we will use the 2256.8 to compute total cost.

This value is substituted into the following formula to determine total minimum annual inventory cost:

$$TC_{\text{min}} = \frac{C_oD}{Q} + \frac{C_cQ}{2} \left(1 - \frac{d}{p}\right)$$

$$= \frac{(150)(10,000)}{2256.8} + \frac{(0.75)(2256.8)}{2} \left(1 - \frac{32.2}{150}\right)$$

$$= \$1329$$

The length of time to receive an order for this type of manufacturing operation is commonly called the length of the *production run*.

$$\text{Production run} = \frac{Q}{p}$$

$$= \frac{2256.8}{150}$$

$$= 15.05 \text{ days per order}$$

The number of orders per year is actually the number of production runs that will be made:

$$\text{Number of production runs (from orders)} = \frac{D}{Q}$$

$$= \frac{10,000}{2256.8}$$

$$= 4.43 \text{ runs per year}$$

Finally, the maximum inventory level is

$$\begin{aligned}\text{Maximum inventory level} &= Q \left( 1 - \frac{d}{p} \right) \\ &= 2256.8 \left( 1 - \frac{32.2}{150} \right) \\ &= 1772 \text{ gallons}\end{aligned}$$

Thus, ePaint will need to set aside storage space sufficient to accommodate these 1772 gallons of paint.

**Quantity Discount model:** Customers are provided price reductions for larger orders in the form of quantity discounts to encourage them to buy in bulk.

If a buyer is offered a quantity discount, he or she must compare the possible benefits of a lower purchase price and fewer orders that come with buying in bulk against the increased carrying costs generated by greater average stocks.

With quantity discounts, the buyer's purpose is to choose the order quantity that will reduce total cost, where the total cost is the sum of carrying, ordering, and purchasing (i.e., product) costs:

$$\begin{aligned}\text{TC} &= \text{Carrying cost} + \text{Ordering cost} + \text{Purchasing cost} \\ &= \left( \frac{Q}{2} \right) H + \left( \frac{D}{Q} \right) S + PD\end{aligned}$$

where

$$P = \text{Unit price}$$

Remember that the purchasing cost is not factored into the standard EOQ model when determining order size. The reason for not adding unit price is that assuming no quantity discounts, the price per unit is the same regardless of order size. In that situation, including unit pricing in the total-cost calculation would simply increase the total cost by  $P$  times  $D$ . A horizontal line would be a graph of total annual purchasing cost vs quantity. As a result, adding purchase costs to the total-cost curve would simply raise it by the same amount ( $PD$ ) at each point. The EOQ would remain unchanged. (Refer to Figure 7.6)

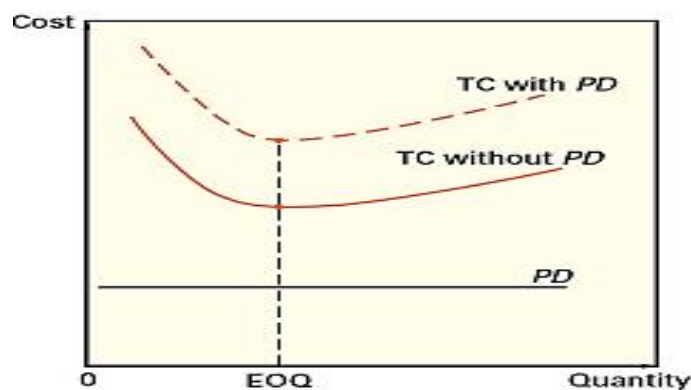

Figure 7.6: The addition of  $PD$  has no effect on  $EOQ$

When quantity reductions are available and each unit pricing has its own U-shaped total-cost curve. Including units, costs raise each curve by the same amount each time. However, each curve is raised by a different amount because the unit prices are all different: A total-cost curve will be raised less by smaller unit prices than by greater unit prices. It's worth noting that no one curve applies to the whole range of values; instead, each curve only applies to a subset of it. As a result, the relevant or feasible total cost begins on the curve with the highest unit price and gradually decreases, curve by curve, until it reaches the price breaks, which are the minimum quantities required to achieve the discounts.

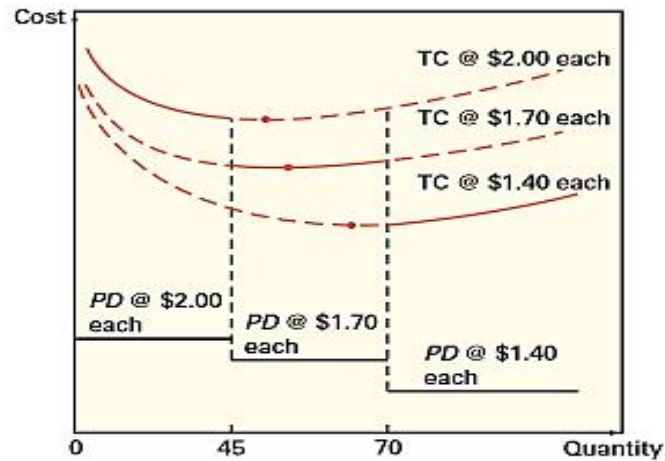

Figure 7.7: A component of the total-cost curve for each pricing is made up of the total-cost curve with quantity discounts

### Numerical

Avtek, a distributor of audio and video equipment, wants to reduce a large stock of televisions. It has offered a local chain of stores a quantity discount pricing schedule, as follows:

Quantity	Price
1-49	\$1400
50-89	1100
90+	900

The annual carrying cost for the stores for a TV is \$190, the ordering cost is \$2,500, and annual demand for this particular model TV is estimated to be 200 units. The chain wants to determine if it should take advantage of this discount or order the basic EOQ order size.

### Solution

First determine the optimal order size and total cost with the basic EOQ model.

$$C_o = \$2500$$

$$C_c = \$190 \text{ per TV}$$

$$D = 200 \text{ TVs per year}$$

$$\begin{aligned} Q_{\text{opt}} &= \sqrt{\frac{2C_o D}{C_c}} \\ &= \sqrt{\frac{2(2500)(200)}{190}} \\ &= 72.5 \text{ TVs} \end{aligned}$$

Although we will use  $Q_{\text{opt}} = 72.5$  in the subsequent computations, realistically the order size would be 73 televisions. This order size is eligible for the first discount of \$1100; therefore, this price is used to compute total cost:

$$\begin{aligned} TC_{\min} &= \frac{C_o D}{Q_{\text{opt}}} + \frac{C_c Q_{\text{opt}}}{2} + PD \\ &= \frac{(2500)(200)}{72.5} + \frac{(190)(72.5)}{2} + (1100)(200) \\ TC_{\min} &= \$233,784 \end{aligned}$$

Since there is a discount for a larger order size than 50 units (i.e., there is a lower cost curve), this total cost of \$233,784 must be compared with total cost with an order size of 90 and a discounted price of \$900:

$$\begin{aligned} TC &= \frac{C_o D}{Q} + \frac{C_c Q}{2} + PD \\ &= \frac{(2500)(200)}{90} + \frac{(190)(90)}{2} + (900)(200) \\ &= \$194,105 \end{aligned}$$

Since this total cost is lower ( $\$194,105 < \$233,784$ ), the maximum discount price should be taken, and 90 units should be ordered. We know that there is no order size larger than 90 that would result in a lower cost, since the minimum point on this total cost curve has already been determined to be 73.

## Summary

- Overstocking locks up cash that could be better used elsewhere, resulting in missed deliveries, lost sales, dissatisfied customers, and production bottlenecks; understocking results in missed deliveries, lost sales, unsatisfied customers, and production bottlenecks.
- In terms of cash spent, profit potential, sales or usage volume, or stockout penalties, an important feature of inventory management is that products retained in inventory are not of equal importance.
- Electric generators, coils of wire, and assorted nuts and bolts, for example, can be among the things carried in inventory by an electrical equipment manufacturer.
- It would be absurd to expect each of these items to receive equal attention.
- Instead, a more realistic strategy would be to divide control efforts among distinct inventory items based on their relative value.
- Inadequate inventory control can lead to both understocking and overstocking of items.

## Keywords

- **ABC system** is a method for classifying inventory items according to their dollar value to the firm based on the principle that only a few items account for the greatest dollar value of total inventory.

- **carrying costs** the cost of holding an item in inventory, including lost opportunity costs, storage, rent, cooling, lighting, interest on loans, and so on.
- **Economic order quantity (EOQ)** is a fixed-order quantity that minimizes total inventory costs.
- **The production quantity model** is also known as the production lot-size model; an inventory system in which an order is received gradually and the inventory level is depleted at the same time it is being replenished.
- **Stock out** an inventory shortage occurs when demand exceeds the inventory in stock.

### **Self Assessment**

1. To achieve \_\_\_ in purchasing and transportation, goods may be purchased in larger quantities than the actual demand.
  - A. Continuation
  - B. Quality
  - C. Cost efficiency
  - D. Potential value
  
2. Which of the following models is used to calculate the timing of the inventory order?
  - A. Economic order quantity model
  - B. Fixed order quantity model
  - C. Reorder point model
  - D. Fixed order inventory model
  
3. The type of inventory method that comprises more number of accounting transactions is known as \_\_\_\_.
  - A. Periodic inventory method
  - B. Perpetual inventory system
  - C. Finished goods inventory method
  - D. Fixed order period inventory system
  
4. In the ABC Analysis system the B category stands for \_\_\_\_.
  - A. Outstanding importance in value
  - B. Comparatively unimportant in value
  - C. Comparatively important in value
  - D. Average importance in value
  
5. Which among the following is a quantity of a specific item that is ordered from the supplier and issued as a standard quantity to the production process?
  - A. Safety stock
  - B. Lot size
  - C. Standard deviation
  - D. Inventory control

6. Which among the following components is calculated as the sum of the fixed costs that happen each time an item is ordered?
- A. Carrying cost
  - B. Order cost
  - C. Holding cost
  - D. Storing cost
7. The price reductions offered to customers for large orders, to encourage them to purchase in large quantities is known as \_\_\_\_.
- A. Freebies
  - B. Quantity discounts
  - C. Normal discounts
  - D. Premiums
8. A company that maintains a sufficient safety margin by having extra inventory against certain situations is termed as \_\_\_\_.
- A. Inventory
  - B. Lot size
  - C. Safety stock
  - D. Lead
9. Which among the following costs is the expense of storing inventory for a specified period of time?
- A. Purchasing cost
  - B. Carrying cost
  - C. Financial cost
  - D. Storing cost
10. The stock level at which the storekeeper initiates purchase requisitions is known as.....
- A. Re-order level
  - B. Danger level
  - C. Maximum stock level
  - D. none
11. ....is a buffer stock level or safety stock level under which the stock should not be allowed to fall.
- A. A Average stock level
  - B. Maximum stock level
  - C. Minimum stock level
  - D. none
12. Which of the following is not an inventory?

- A. Machines
  - B. Raw material
  - C. Finished products
  - D. Consumable tools
13. The following classes of costs are usually involved in inventory decisions except
- A. Cost of ordering
  - B. Carrying cost
  - C. Cost of shortages
  - D. Machining cost
14. The cost of insurance and taxes are included in
- A. Cost of ordering
  - B. Set up cost
  - C. Inventory carrying cost
  - D. Cost of shortages
15. The minimum stock level is calculated as
- A. Reorder level – (Normal consumption × Normal delivery time)
  - B. Reorder level + (Normal consumption × Normal delivery time)
  - C. (Reorder level + Normal consumption) × Normal delivery time
  - D. (Reorder level + Normal consumption) / Normal delivery time

### **Answers for Self Assessment**

- |       |       |       |       |       |
|-------|-------|-------|-------|-------|
| 1. C  | 2. C  | 3. B  | 4. D  | 5. B  |
| 6. B  | 7. B  | 8. C  | 9. B  | 10. A |
| 11. C | 12. A | 13. D | 14. C | 15. A |

### **Review Questions**

1. Describe the difference between independent and dependent demand and give an example of each for a pizza restaurant such as Domino or Pizza Hut.
2. What are the assumptions of the basic EOQ model, and to what extent do they limit the usefulness of the model?
3. Identify the two basic decisions addressed by inventory management and discuss why the responses to these decisions differ for continuous and periodic inventory systems.
4. Distinguish between a fixed-order-quantity system and a fixed-time-period system and give an example of each.
5. Explain how the order quantity is determined using the basic EOQ model.
6. Describe the major cost categories used in inventory analysis and their functional relationship to each other.

7. The purchasing agent for a company that assembles and sells air-conditioning equipment in a Latin American country noted that the cost of compressors has increased significantly each time they have been reordered. The company uses an EOQ model to determine order size. What are the implications of this price escalation with respect to order size? What factors other than price must be taken into consideration?
8. Explain how a decrease in setup time can lead to a decrease in the average amount of inventory a firm holds, and why that would be beneficial.
9. How has technology aided inventory management? How have technological improvements in products such as automobiles and computers impacted inventory decisions?
10. To be competitive, many fast-food chains began to expand their menus to include a wider range of foods. Although contributing to competitiveness, this has added to the complexity of operations, including inventory management. Specifically, in what ways does the expansion of menu offerings create problems for inventory management?



### **Further Readings**

- Operations Management by Norman Gaither, Cengage Learning
- Operations Management by Russell And Taylor, Wiley



### **Web Links**

- Economic Order Quantity-  
<https://www.netsuite.com/portal/resource/articles/inventory-management/economic-order-quantity-eoq.shtml>
- ABC Analysis in Inventory Management: Benefits & Best Practices-  
<https://www.netsuite.com/portal/resource/articles/inventory-management/abc-inventory-analysis.shtml?whence=>



## Unit 08: Basics of Supply Chain Management

### CONTENTS

Objectives

Introduction

- 8.1 Concept of Supply Chain
- 8.2 Purpose of Supply Chain Management
- 8.3 Supply Chain Management Decisions Areas
- 8.4 Concept of Logistics
- 8.5 Benefits of Effective Supply Chain Management
- 8.6 Concept of Reverse Logistics
- 8.7 Requirements and Steps for Creating an Effective Supply Chain
- 8.8 Lean Supply Chain
- 8.9 Agile Supply Chain

Summary

Keywords

Self Assessment

Answers for Self Assessment

Review Questions

Further Readings

### Objectives

After studying this unit, you will be able to:

- Understand the concept of supply chain management and how it enhances the value proposition of the business.
- Get familiarity with the strategic, tactical, and operational responsibilities of supply chain management.
- Understand the various popular approaches of SCM like Agile Supply chain Management and Lean manufacturing.
- Understand the role of Logistics in SCM.

### Introduction

A supply chain is the chain of companies that are involved in producing and delivering a product or service, including their facilities, operations, and activities. The cycle starts with basic raw material suppliers and continues all the way to the final client. Warehouses, factories, processing centers, distribution centers, retail stores, and offices are examples of facilities.

Forecasting, purchasing, inventory management, information management, quality assurance, scheduling, production, distribution, delivery, and customer service are some of the functions and operations. The strategic coordination of business functions inside a corporate organization and throughout its supply chain with the purpose of integrating supply and demand management is known as supply chain management. People at various levels of an organization's supply chain are in charge of managing supply and demand both within and across corporate organizations. They are in charge of planning and coordinating tasks such as sourcing and procuring materials and services, as well as transformation and logistics.

Logistics refers to the forward and reverse flow of commodities, services, money, and information in a supply chain. Inbound and outgoing transportation, material handling, warehousing, inventory, order fulfillment and distribution, third-party logistics, and reverse logistics are all examples of logistics management (the return of goods from customers). Every company is involved in at least one supply chain, and many are involved in numerous supply chains. Whether a supply chain is manufacturing or service-oriented often determines the number and type of firms in it.

## 8.1 Concept of Supply Chain

A supply chain is made up of all parties involved in completing a customer's request, whether directly or indirectly. Not only do manufacturers and suppliers play a role in the supply chain, but so do transporters, warehouses, retailers, and even customers. The supply chain encompasses all functions involved in receiving and fulfilling a customer request inside each firm, such as a manufacturer. New product creation, marketing, operations, distribution, financing, and customer support are just a few of these functions.

Consider a customer who comes into a Wal-Mart to buy detergent. The customer and his or her requirement for detergent are at the start of the supply chain. The customer visits the Wal-Mart retail shop, which is the next stage in the supply chain.

Wal-Mart replenishes its shelves with products sourced from a finished-goods warehouse or a distributor utilizing trucks provided by a third party. The manufacturer, in turn, stocks the distributor (say, Proctor & Gamble [P&G] in this case). Raw materials for the P&G manufacturing plant come from a variety of sources, some of which may have been supplied by lower-tier suppliers. Packaging material, for example, may come from the Tenneco package, but Tenneco receives raw materials from other sources to create the packaging. Figure 8.1 depicts this supply chain, with the arrows indicating the direction of physical product flow.

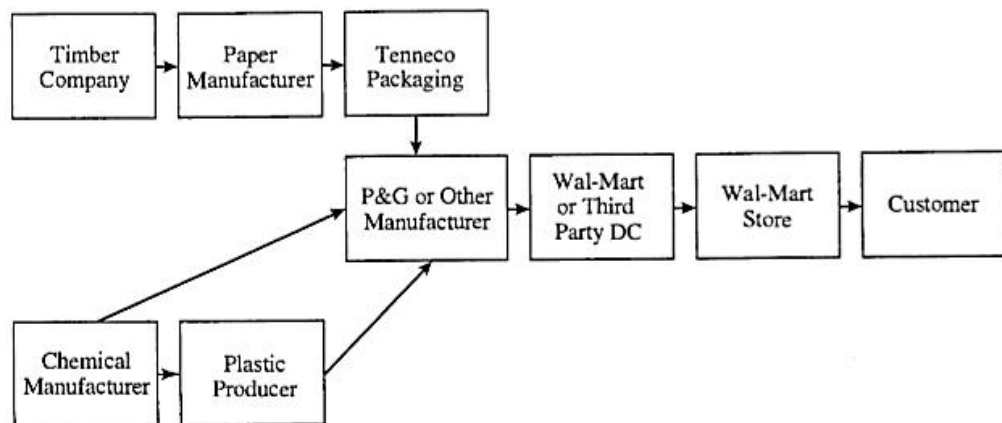

Figure 8.1: Supply Chain System

The ongoing flow of information, goods, and cash between phases of a supply chain makes it dynamic. Wal-Mart, in our case, gives the customer the goods as well as pricing and availability information. Wal-Mart receives the payments from the customer.

Wal-Mart sends point-of-sale data and replenishment orders to a warehouse or distributor, which then transports the replenishment order back to the store via trucks. Following the refill, Wal-Mart sends cash to the distributor. The distributor also delivers Wal-Mart pricing information and delivery timetables. Wal-Mart may return your packaging to be recycled. Throughout the supply chain, similar information, materials, and funds are exchanged.

Every supply chain's goal should be to maximize the overall value created. The difference between what the end product is worth to the client and the costs the supply chain incurs in fulfilling the customer's request is the value a supply chain generates. For most commercial supply chains, value is highly connected with supply network profitability (also known as supply chain surplus), which is the difference between customer revenue and overall supply chain costs.

Within the supply chain, all flows of information, product, or finances produce expenses. As a result, effective management of these flows is critical to supply chain performance. To

maximize entire supply chain profitability, effective supply chain management encompasses the management of supply chain assets and products, information, and capital flows.



#### Notes:

- Supply chains are also known as value chains, a word that refers to the concept of adding value to commodities and services as they move through the chain.
- Rather than being made up of just one company, supply or value chains are usually made up of several.
- Furthermore, any organization's supply or value chain has two components: a supply component and a demand component.
- The supply component begins at the beginning of the supply chain and concludes with the organization's internal activities.
- The demand component of the chain begins with the delivery of the organization's output to its immediate client and concludes with the chain's final customer.
- The sales and distribution segment of the value chain is known as the demand chain.
- Any corporate organization's supply network is its lifeblood.
- They form a network that connects suppliers, producers, and final customers for the creation and delivery of goods and services.
- The process of designing, implementing, and controlling supply chain operations is known as supply chain management.
- Strategy, procurement, supply management, demand management, and logistics are the essential components.

## 8.2 Purpose of Supply Chain Management

The purpose of supply chain management is to efficiently and effectively match supply to demand.

The following are some of the most important factors to consider:

1. Determining the right level of outsourcing.
2. Procurement management.
3. Managing vendors.
4. Keeping track of customer relationships.
5. The ability to recognize and respond to problems rapidly.

Flow management is an important part of supply chain management. Product and service flow, information flow, and financial flow are the three forms of flow that must be handled. The transfer of goods or services from suppliers to customers, as well as the management of customer service requests and product returns, are all part of the product and service flow.

Sharing forecast and sales data, conveying orders, tracking shipments, and updating order status are all part of the information flow. Credit periods, payments, consignment, and title ownership arrangements are all part of the financial flow. The ability to efficiently control these flows has substantially improved because of technological advancements.

## 8.3 Supply Chain Management Decisions Areas

Many decisions about the movement of information, product, and cash are required for the successful supply chain management. Every choice should be taken with the goal of increasing supply chain excess. Depending on the frequency of each decision and the time span during which a decision phase has an impact, these decisions are divided into three groups or phases. As a result, each decision category must take into account uncertainty over the decision horizon.

**1. Supply Chain Strategy or Design:** During this phase, a company decides how to structure the supply chain for the next several years, based on the marketing and price plans for a product. It determines the chain's configuration, resource allocation, and the processes that each stage will perform. Companies make strategic decisions about whether to outsource or perform supply chain functions in-house, the location and capacity of production and warehousing facilities, the products to be manufactured or stored at various locations, the modes of transportation to be made available along various shipping legs, and the type of information system to be used. During this phase, a company must verify that its supply chain configuration supports its strategic goals and increases supply chain surplus.

**2. Supply Chain Planning:** The time span examined for decisions made during this phase is a quarter to a year. As a result, the supply chain structure established during the strategic phase is set in stone. This setup defines the parameters within which planning must take place. Given the limits imposed during the strategic or design phase, the purpose of planning is to maximize the supply chain surplus that can be generated throughout the planning horizon. Companies begin the planning phase by forecasting demand in various markets for the future year (or a comparable time range). Making decisions on which markets will be serviced from which locations, manufacturing subcontracting, inventory policies to be followed, and the timing and size of marketing and pricing promotions are all part of planning. Planning decisions are Dell's judgments about markets served by a production facility and intended production quantities at each site. Planning specifies the parameters under which a supply chain will operate during a given time period. Companies must factor unpredictability in demand, exchange rates, and competition into their planning decisions over this time frame. Companies in the planning phase strive to leverage any flexibility built into the supply chain in the design phase and exploit it to maximize performance, given a shorter time frame and better projections than in the design phase. Companies create a set of operating policies that regulate short-term operations as a result of the planning process.

**3. Supply Chain Operation:** During this phase, companies make judgments on specific customer orders on a weekly or daily basis. The supply chain configuration is deemed established at the operational level, and planning policies are already defined. The purpose of supply chain operations is to efficiently process incoming client orders. Firms allocate inventory or production to individual orders, set a date for filing an order, prepare pick lists at a warehouse, and assign an order to a certain shipping method and shipment, set truck delivery schedules, and place replenishment orders during this phase. There is less ambiguity about demand information since operational decisions are made in the near period (minutes, hours, or days). The purpose of the operation phase is to leverage the decrease of uncertainty and optimize performance, given the limits imposed by the configuration and planning policies.

**Process View of Supply Chain:** A supply chain is a series of operations and flows that occur inside and across stages in order to fulfil a customer's product need.

There are two ways to look at the processes that take place in a supply chain.

**1. Cycle View:** A supply chain's processes are divided into a series of cycles, each of which is carried out at the interface between two levels of the supply chain. These Cycles are as follows

Customer order cycle • Replenishment cycle • Manufacturing cycle • Procurement cycle

**2. Push/Pull View:** A supply chain's processes are classified into two groups based on whether they are carried out in reaction to a customer order or in anticipation of customer orders.

Pull operations are started and completed in response to a client order, whereas push processes are started and completed in advance of consumer orders.

## **8.4 Concept of Logistics**

In a supply chain, logistics refers to the transportation of materials, services, money, and information. All of the physical elements used in a manufacturing process are referred to as materials. Fuels, equipment, parts, tools, lubricants, office supplies, and other support products are available in addition to raw materials and work in progress. Movement within a facility, oversight of incoming and departing shipments of goods and resources, and information flow along the supply chain are all part of logistics.

**Within a Facility, Movement:** Production control includes the movement of goods within a manufacturing facility.

Figure 8.1 depicts the various stages during which materials pass through a manufacturing facility:

1. from receiving vehicles to incoming vehicles.
2. from the point of receipt to the point of storage
3. from storage to consumption (e.g., a work centre).
4. Transferring from one work centre to the next or temporarily storing items.
5. from the last action to the last piece of storage
6. from warehousing to packaging and shipment.
7. from shipping to vehicle departure.

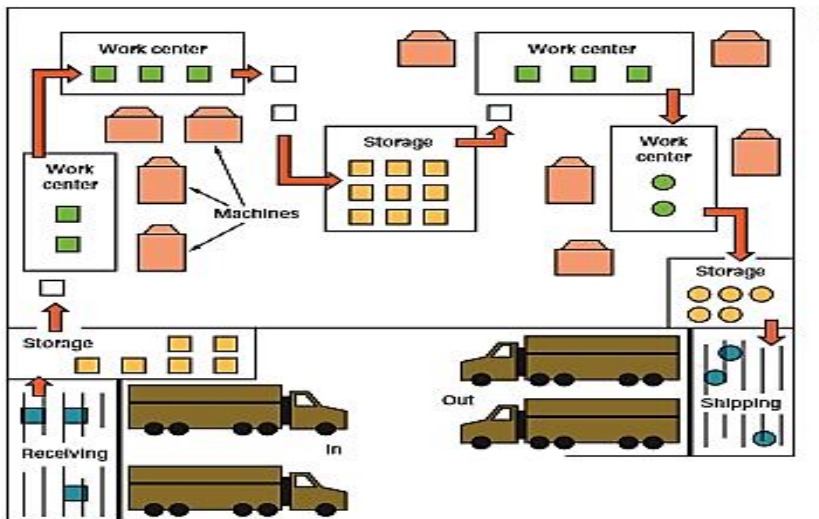

Figure 8.1: Movement within Facility

In some cases, the commodities being moved are supplies; in others, the goods are finished or partially finished products; and in still others, the goods are raw materials or acquired parts. The material movement must be coordinated so that it arrives at the right places at the right time. During movement, workers and supervisors must take care to avoid losing, stealing, or damaging items.

**Shipments arriving and Departing:** The term "traffic management" refers to the process of coordinating the shipment of incoming and exiting products. This function manages shipping schedules and decisions, taking into account the costs of various options, government regulations, the organization's needs in terms of quantities and timing, and external factors such as potential shipping delays or disruptions (e.g., highway construction, trucker strikes). Computer tracking of shipments is frequently used to keep track of current shipments and to provide additional up-to-date information on costs and scheduling.

#### Application of RFID

RFID (Radio Frequency Identification) is a technology that allows you to track your goods. The way firms track commodities in their supply networks is changing because of technological advancements. RFID, or radio frequency identification, is a technology that uses radio waves to identify objects in supply chains, such as commodities. This is accomplished by using an RFID tag affixed to an object. The tag contains an integrated circuit and an antenna that uses radio waves to transmit information or other data to network-connected RFID readers. Pallets, cases, and individual objects can all be labeled with RFID tags. They enable enterprises to identify, track, monitor, or locate virtually any object in the supply chain that is within range of a tag reader. These tags are similar to bar codes, but they have the advantage of being able to carry a lot more information and not requiring line-of-sight scanning as bar codes do. Multiple RFID tags can be read concurrently and automatically, unlike bar codes, which must be scanned separately and usually by hand. Furthermore, compared to a bar code, an RFID tag delivers more specific information:

Bar codes just indicate an object's classification, such as its stock-keeping unit, whereas tags carry specific information on each item (SKU). This allows management to track the whereabouts of every object in the supply chain. RFID has the ability to revolutionize the way businesses maintain inventories and share data, as well as substantially improve supply chain management. This technology improves inventory management, quality control, and supplier and customer relationships while increasing supply chain visibility.

At receiving docks, warehouses, and retail shelves, RFID removes the need for manual counting and bar-code scanning of items. This reduces errors and speeds up the process significantly. By putting readers at building exits and in parking lots, tags could prevent staff and customer theft. Other benefits include improved accuracy in warehouse "picking" of things for transportation or assembly, improved accuracy in dispensing drugs to patients in hospitals, and reduced surgical errors. Small, agile businesses may be able to compete with larger, more bureaucratic businesses that are sluggish to implement this new technology thanks to RFID. Large businesses, on the other hand, may be better able to afford the charges. These costs include the tags themselves, as well as the cost of attaching individual tags, readers, and computer gear and software to send and analyze the data generated.

The potential benefits for supply chain management are enormous, and merchants and manufacturers are expected to embrace RFID technology in large numbers.

Businesses must first assess the capabilities of their existing information systems, then identify where RFID can have the greatest impact, estimate the time and resources required to implement the new system, estimate the risks and rewards of early versus late adoption, and finally choose the best course of action.

At the retail level, major problems include privacy concerns if tags are not deactivated after items have been purchased and tag placement so that critical customer information is not hidden on products.

The term "third-party logistics" (3-PL) refers to the outsourcing of logistics management. Organizations are outsourcing their warehousing and delivery to specialized companies. Taking advantage of specialists' experience, their well-developed information system, and their capacity to secure more favorable shipping rates, as well as allowing the company to focus more on its main business, is some of the potential benefits.

## **8.5 Benefits of Effective Supply Chain Management**

- Customer satisfaction has improved...
- Operating costs have decreased...
- Cash flow has improved.
- Procurement and sourcing are more efficient.
- Ensure the supply of raw materials is not jeopardized.
- Inventory management that is more efficient...
- Improved relationships with distributors...
- Ensure that legal and ethical guidelines are followed.



### **Notes:**

- Depending on whether they are at the customer or supplier interface or are inside to the company, all supply chain processes can be divided into three macro processes.
- The CRM macro process encompasses all operations that work to originate, receive, and track customer orders at the firm-customer interface.
- The ISCM macro process encompasses all internal supply chain operations that operate to plan for and fulfil customer orders.
- All supply chain operations at the interface between the firm and its suppliers that work to evaluate and choose suppliers and then source goods and services from them make up the SRM macro process.

- Due to a lack of strategic alignment between the competitive and supply chain strategies, the supply chain may take activities that are inconsistent with customer needs, resulting in a decrease in supply chain surplus and profitability.
- All functions inside a company and stages in the supply chain must work toward the same goal, which must be aligned with client needs.
- To achieve a strategic fit, a business must first comprehend the needs of the clients it serves, as well as the supply chain's unpredictability and the implied uncertainty.
- The second step is to comprehend the supply chain's efficiency and responsiveness capabilities.
- The key to strategic fit is ensuring supply chain responsiveness is in line with customer expectations, supplier capabilities, and the implicit unpredictability that results.

## **8.6 Concept of Reverse Logistics**

Reverse logistics is a form of supply chain management in which goods are returned from customers to vendors or producers.

Reverse logistics is required for activities such as returns and recycling after a client receives a product. Reverse logistics begins with the end-user and works its way backward through the supply chain to the distributor or from the distributor to the manufacturer.

Reverse logistics can also refer to operations in which the end-user is responsible for the product's final disposal, such as recycling, refurbishment, or resale.

When items travel from their final destination back through the supply chain to the seller and may be back to the suppliers, organizations use reverse logistics.

The purpose is to either recover or dispose of the product's value. Returns are worth about a trillion dollars worldwide each year, and they've become more common as e-commerce has grown. Reverse logistics aims to recoup value while also ensuring repeat business. In-store purchases are returned less than 10% of the time, whereas internet purchases are returned at least 30% of the time. Reverse logistics is used by smart businesses to increase client loyalty and repeat business while reducing return losses.

## **8.7 Requirements and Steps for Creating an Effective Supply Chain**

A complete review of all components of the supply chain is required to create an effective supply chain. The term "strategic sourcing" is sometimes used to characterize the procedure.

Strategic sourcing is a method of examining product and service purchases in order to cut costs by eliminating waste and non-value-added activities, boosting profits, lower risks, and improving supplier performance.

In contrast to more typical sourcing, strategic sourcing focuses on overall cost rather than buy price. In addition to the purchase price, total expenses include storage, repair, disposal, and sustainability costs. It also works to reduce costs by consolidating purchasing power, relying on fewer suppliers and collaborative relationships, eliminating redundancies, and utilizing cross-functional teams to assist overcome typical organizational challenges.

Typically, establishing a supply chain entails the following steps:

**1. Make a strategy:** Create a strategy for managing all of the resources involved in satisfying predicted customer demand for a product or service, as well as a set of KPIs to track the supply chain.

**2. The origin:** Choose vendors who will provide the items and services required to develop products or give support services. Create a system for delivering, receiving, and confirming shipments or services as well. Payment should be structured along with KPIs for tracking and, if necessary, enhancing relationships.

**3. Create.** Create the procedures for providing services or manufacturing, testing, and packaging products. Quality, service levels, or production output, as well as labour productivity, should all be monitored.

**4. Make a delivery:** Develop a network of warehouses; choose carriers to convey goods to clients; set up an invoicing system to accept payments and construct a communication system for two-way information flow among supply chain participants.

**5. Keep track of your returns.** Establish a flexible and responsive network for accepting damaged and excess products from consumers.

Integration of all components of the supply chain is required to achieve a successful supply chain. The goal is to establish a cooperative relationship amongst supply chain partners that will make activity planning and coordination easier. To achieve this, the following requirements must be met:

**Trust:** It is critical for major trading partners to have trust in one another and to believe that they share similar aims and will act in mutually beneficial ways.

**Communication that works.** Integrated technologies and standardized ways of interacting among partners are required for effective supply chain communication.

**The rate of information flow:** Information velocity is critical; the faster (two-way) information flows, the better.

**Visibility of the supply chain:** A significant trading partner with supply chain visibility can connect to any component of its supply chain in real-time to access data on inventory levels, shipping status, and other vital information. This necessitates information sharing.

**Capability to manage events:** The capacity to recognize and respond to unforeseen occurrences such as a delayed shipment or a warehouse running out on a certain commodity is known as event management. Monitoring the system; notifying when certain planned or unplanned events occur; simulating potential solutions when an unplanned event occurs; and measuring the long-term performance of suppliers, transporters, and other supply chain partners in the supply chain are all capabilities that an event management system should have.

**Metrics for measuring performance.** Performance measurements are required to confirm whether the supply chain is operating as intended or whether there are issues that need to be addressed. There is a range of metrics that may be used to track late deliveries, inventory turnover, reaction time, and quality issues, among other things. In the retail industry, the fill rate (the percentage of demand met by stock on hand) is frequently critical. Other important performance indicators are listed in Table 8.1

<b>Financial</b>	<b>Operations</b>	<b>Order fulfillment</b>
Return on assets	Productivity	Order accuracy
Cost	Quality	Time to fill orders
Cash flow		Percentage of incomplete orders shipped
Profits		Percentage of orders delivered on time
<b>Suppliers</b>	<b>Inventory</b>	<b>Customers</b>
Quality	Average value	Customer satisfaction
On-time delivery	Turnover	Percentage of customer complaints
Cooperation	Weeks of supply	
Flexibility		

Table 8.1: Supply Chain Performance Indicators

**Concept of Return ability** For a variety of causes and under a variety of circumstances, products are returned to corporations or third-party handlers.

The following are some of them:

- Products that is defective.
- Products that have been recalled
- Products that is no longer in use.
- Products that have been returned to retailers because they were unsold.



- Field replacement of parts.
- Recyclable materials
- Debris. (Waste Materials)

The fact that the annual value of returns in the United States is projected to be in the area of \$100 billion emphasizes the importance of returns. Previously, most objects were thrown, with the exception of unsold articles.

More lately, businesses have realized that returned things can be worth a lot of money. Defective parts, for example, can be repaired or replaced, and reconditioned products can be resold. Obsolete items may contain parts or subassemblies that can be reused, or they may have value in other markets.

Parts that are replaced in the field may not be defective at all; it is estimated that around a third of these parts are not defective at all and can be reused as "reconditioned" replacement parts.

Other waste and useless products and parts may require disposal according to sometimes rigorous rules; recyclable items can be sold to recyclers and may be used for energy production; other waste and unusable products and parts may require disposal according to sometimes stringent guidelines. Governments, notably in Europe, are increasingly passing regulations requiring original manufacturers to acquire and dispose of their products at the end of their useful life.

Two key elements of managing returns are gate keeping and avoidance. Gate keeping oversees the acceptance of returned goods with the intent of reducing the cost of returns by screening returns at the point of entry into the system and refusing to accept goods that should not be returned or goods that are returned to the wrong destination. Effective gate keeping enables organizations to control the rate of returns without negatively impacting customer service. Avoidance refers to finding ways to minimize the number of items that are returned. It can involve product design and quality assurance. It may also involve monitoring forecasts during promotional programs to avoid overestimating demand to minimize returns of unsold products. The condition of returned products, as well as the timing of returns, can be unpredictable, making planning for the reverse flow problematic. Returns, on the other hand, can provide useful information, such as how and why errors happened, which can be used to enhance product quality and/or design and reduce future returns. They can also assist in identifying some areas of client unhappiness, which can benefit design.

## 8.8 Lean Supply Chain

A lean supply chain is one that is performing at its peak: it delivers items or products to the end consumer as efficiently as possible, with low waste and loss, and with enough flexibility to respond to unanticipated delays. In essence, a lean supply chain is a consequence of trimming the fat, such as ensuring that products do not spend too much time in warehouses where they are unproductive or removing any superfluous operational expenditures (such as excessive fuel consumption).

The Lean Supply Chain is a network of interconnected and interdependent partners working together to achieve supply chain goals. To ensure performance throughout the supply chain, metrics should be used to track these goals. To ensure supply chain success, these parameters should be checked on a regular basis.

The following are the steps taken to achieve these goals:

- i. Remove all waste from the supply chain, leaving just value.
- ii. Take advantage of technological advancements to improve the supply chain
- iii. Make customer usage visible to all supply chain members
- iv. Shorten the Lead Time
- v. Make a Level Flow/Level Load diagram.
- vi. Use Kanban-style pull systems.
- vii. Increase throughput and reduce variation by increasing velocity and throughput.
- viii. Use Process Discipline and Collaborate
- ix. Concentrate on the total cost of fulfillment.

**Customers can take advantage of the following advantages:**

- Customer satisfaction and fill rate have increased.
- Increased supply chain visibility and performance measurement
- Management of Risk
- Inventory turnover and stock decrease
- Transportation cost reduction in distribution centers using 5S, Kaizen/Continuous Improvement, and Lean Six Sigma: for example, use your or your Third-Party Logistics (3PL) provider partner's Transportation Management System (TMS) to optimize your freight so you add value and reduce costs by using the most efficient lanes and routes.
- Increased supplier performance: shortening lead times and lowering costs because your suppliers are specialists in their fields.
- Request that your suppliers hold a Supplier Day Conference every now and then to hunt for cost savings through Value Analysis.
- Reduction of the entire supply chain's "Total Cost"

## 8.9 Agile Supply Chain

An agile supply chain is a supply network that has the ability to respond to changing demands in a way that expedites the delivery of ordered goods to customers. Simply put, supply chain agility is a practice that many businesses use to select a dealer.

As we all know, a supply chain with flexibility and the ability to respond rapidly to emergency needs can help a company respond to its consumers more efficiently. Aside from flexibility, this sort of supply chain is also known for its speed and precision.

To appreciate the benefits of an agile supply chain, one must first understand the components of any supply chain. These include factors such as order collection and processing, supply of materials to make commodities required completing orders, packing and transportation of finished goods, and the level of customer service advertised throughout the process from point of sale through delivery and beyond. As a result, in order to consider supply chain functions to be agile, each of these pieces must be managed and coordinated in a way that allows them to react to changing circumstances. When it comes to scheduling production time, selecting shippers, and basically looking closely at each step in the order completion process to find ways to reduce the time required to successfully complete those tasks while still adhering to the customer's request, merchants must think creatively and with some flexibility.

A corporation can use agile supply to:

- Inventory should be rationalized.
- Cost-cutting
- Create a reliable supply chain.
- In a continuously changing and turbulent trading environment, agile supply chains can adjust to meet unanticipated client demand.
- Agile supply networks have the ability to manufacture a wide range of products in a short amount of time.
- The improvement in profit margins is aided by rationalizing inventory levels and cutting expenditures.

With each passing day, the complexity of the modern supply chain for businesses becomes more complex. While many firms have adopted the lean supply chain idea, thanks to advancements in digital technology, agile supply chain management is becoming more common. It works by comparing real-time data to demand estimates in the future. It also gives the chance to use what organizations need now to boost productivity and efficiency in the future.

## Summary

- Overstocking locks up cash that could be better used elsewhere, resulting in missed deliveries, lost sales, dissatisfied customers, and production bottlenecks, under stocking results in missed deliveries, lost sales, unsatisfied customers, and production bottlenecks.
- In terms of cash spent, profit potential, sales or usage volume, or stock out penalties, an important feature of inventory management is that products retained in inventory are not of equal importance.
- Electric generators, coils of wire, and assorted nuts and bolts, for example, can be among the things carried in inventory by an electrical equipment manufacturer.
- It would be absurd to expect each of these items to receive equal attention.
- Instead, a more realistic strategy would be to divide control efforts among distinct inventory items based on their relative value.
- Inadequate inventory control can lead to both under stocking and overstocking of items.

## Keywords

**The bullwhip effect** occurs when demand variability is magnified at various upstream points in the supply chain.

**Radiofrequency identification (RFID)** radio waves are used to transfer data, like an electronic product code, between an item with an embedded microchip and a reader.

**A supply chain** is the facilities, functions, and activities involved in producing and delivering a product or service from suppliers (and their suppliers) to customers (and their customers).

**Supply chain management (SCM)** manages the flow of information through the supply chain in order to attain the level of synchronization that will make it more responsive to customer needs while lowering costs.

**Sustainability** means meeting present needs without compromising the ability of future generations to meet their needs.

## Self Assessment

1. Value in logistics is expressed in terms of:-
  - A. Time and place
  - B. Time and cost of giving service
  - C. Only time
  - D. Only place
2. Which of the following is not a supporting activity of the supply channel?
  - A. Protective packaging
  - B. Warehousing
  - C. Information flows and order processing
  - D. Purchasing
3. Which of the following parameter has contributed to rapid customer order processing, quick delivery, and a high degree of product availability?
  - A. Internet
  - B. Non-continuous replenishment of inventories

- C. EOQ
  - D. Cross-docking
4. It is generally recognized that business creates four types of values in products or services i.e. form, time, place, and possession. Manufacturing firms create \_\_\_\_\_ value out of these four.
- A. Form
  - B. Time
  - C. Place
  - D. Possession
5. \_\_\_\_\_ value is often the responsibility of marketing, engineering, and finance, where the value is created by helping customers acquire the product through advertisements.
- A. Form
  - B. Time
  - C. Place
  - D. Possession
6. "A network of manufacturers and service providers that work together to convert and move goods from the raw materials stage through to the end user" is the definition of
- A. Supply chain.
  - B. Operations management.
  - C. Service operations.
  - D. Operations function.
7. The supply chain function works with marketing and engineering to identify and qualify suppliers of goods and services as well as manage ongoing supplier relationships. This supply chain activity is
- A. Logistics
  - B. Purchasing
  - C. Capacity Planning
  - D. Forecasting
8. The supply chain function works with finance and accounting on determining capital investments in manufacturing plants and resource levels, such as workforce. This supply chain activity is
- A. Purchasing
  - B. Capacity Planning
  - C. Forecasting
  - D. Logistics

- 
9. The supply chain function works with marketing to develop planning numbers, such as customer demand and availability of supply, which are needed for effective decision making. This supply chain activity is
- A. Purchasing
  - B. Logistics
  - C. Forecasting
  - D. Capacity Planning
10. The supply chain function works with marketing to manage the movement of physical goods throughout the supply chain. This supply chain activity is
- A. Capacity Planning
  - B. Purchasing
  - C. Logistics
  - D. Forecasting
11. Identify from the following list a major strategic risk associated with outsourcing.
- A. Outsourcing landed cost is usually higher than in sourcing cost.
  - B. The supplier is purchased by a competitor.
  - C. The business loses sight of market trends.
  - D. The cost of supplied material is passed on to the customer.
12. "3PL" involves using a supplier to provide \_\_\_\_\_ services.
- A. Marketing
  - B. Design
  - C. Logistics
  - D. Contract manufacturing
13. What activity involves the movement of goods into a warehouse, the placement of goods in a warehouse, and the movement of goods from storage to order picking areas and eventually to dock areas for transportation out of the warehouse?
- A. Materials handling,
  - B. Physical distribution,
  - C. Business logistics,
  - D. Order fulfillment.
14. Which one is not a reason for increased emphasis on supply chain management?
- A. Increased levels of outsourcing
  - B. Increased transportation costs
  - C. Trends toward globalization
  - D. The need to improve internal operations
15. Which one refers to reverse logistics?
- A. Returned goods

- B. Retracing the steps in a supply chain
- C. Cross-docking
- D. Customer refusal to accept damaged goods

### Answers for Self Assessment

- |       |       |       |       |       |
|-------|-------|-------|-------|-------|
| 1. A  | 2. C  | 3. A  | 4. A  | 5. D  |
| 6. A  | 7. B  | 8. B  | 9. C  | 10. C |
| 11. B | 12. C | 13. A | 14. D | 15. D |

### Review Questions

1. Define the strategic goals of supply chain management and indicate how each element of a supply chain (purchasing, production, inventory, and transportation and distribution) has an impact on these goals.
2. As Amazon.com grew rapidly after it first went "online" with Internet sales in 1995, it experienced several supply chain problems that other retail companies like L.L. Bean, Sears, and J.C. Penney were able to avoid. What might some of these problems be and why did Amazon and other dot.com companies experience them?
3. Walmart is one of the leaders in promoting the development and use of RFID and electronic product codes. Explain how Walmart plans to use RFID, why Walmart wants its suppliers to adopt RFID, and what obstacles you think may exist for this new technology.
4. Describe the supply chain for your university or college. Who are the suppliers, producers, and distributors in this supply chain? Are there different supplier tiers? How would you evaluate this supply chain? Does inventory even exist, and if it does, what form does it take?
5. What is the bullwhip effect, and why does it occur? How can it be overcome?
6. What are the elements of supply chain management? What are the strategic, tactical, and operations responsibilities in supply chain management?
7. What is meant by the term inventory velocity and why is this important? What is information velocity, and why is it important?
8. What trade-offs are involved in
  - (a) sharing information with other organizations in a supply chain and
  - (b) the acquisition of information-processing technology?
9. Who needs to be involved in
  - (a) decisions on technology acquisition for supply chain management and
  - (b) supply chain management?
10. Name three different ways that technology has improved the ability to manage supply chains.



### Further Readings

- Operations Management by Norman Gaither, Cengage Learning
- Operations Management by Russell And Taylor, Wiley



## Web Links

- Reverse Logistics-  
[https://www.logisticsmgmt.com/article/its\\_time\\_to\\_transform\\_reverse\\_logistics](https://www.logisticsmgmt.com/article/its_time_to_transform_reverse_logistics)
- The Reverse Logistics Crisis: The Avalanche of Returns-  
<https://www.dcvelocity.com/articles/53723-the-reverse-logistics-crisis-the-avalanche-of-returns>

## Unit 09: JIT and Lean Operations

### CONTENTS

Objectives

Introduction

9.1 JIT - Background and History

9.2 The Toyota Approach

9.3 Goals and Building Blocks of Lean Systems

9.4 Building Blocks

Summary

Keywords

Self Assessment

Answers for Self Assessment

Review Questions

Further Readings

### Objectives

After studying this unit, you will be able to:

- Understand concept of Lean management
- Understand concepts developed by Toyota
- Understand different blocks of lean system

### Introduction

It initially refers to the creation of goods to precisely fulfil customer demand in terms of time, quality, and quantity, regardless of whether the 'customer' is the product's end purchaser or another process farther down the production line.

#### 9.1 JIT - Background and History

JIT is a Japanese management style that has been used in many Japanese manufacturing companies since the early 1970s. Taiichi Ohno first created and polished it within Toyota manufacturing plants as a way to meet customer expectations with minimal delays. JIT's founder, Taiichi Ohno, is often referred to as the "Father of JIT."

Toyota was able to tackle the ever-increasing problems of survival by focusing on people, plants, and systems. Toyota realized that JIT would only be successful if every employee was involved and dedicated to it, if the plant and processes were set up for maximum output and efficiency, and if quality and production programmes were precisely scheduled to meet demand.

When appropriately adapted to the organization, JIT manufacturing has the potential to significantly improve the organization's competitiveness in the marketplace by eliminating waste and enhancing product quality and production efficiency.

#### 9.2 The Toyota Approach

Many of the methods that are common to lean operations were developed as part of Japanese car maker Toyota's approach to manufacturing. This include following concepts:



### Muda, Mura and Muri

These are considering three enemies of lean system. These are interrelated and thus need to be addressed simultaneously.

**Muda:** Muda means waste and inefficiencies. Muda can be found in manufacturing as well as in services. In production, waste is easy to notice and account whereas it is hidden in most of the services. In an ideal world, a production unit can be next to the source of raw material and markets. This could have resulted in non-requirement of inventory. In real world, markets and suppliers are wide apart and route optimization becomes a challenge in the competitive world. Organizations try to optimize lot size during procurement or sales. Variability in market makes storage a necessary condition at each link of the supply chain. Thus, complete elimination of wastages and inefficiencies is practically impossible. Muda identifies following wastages:

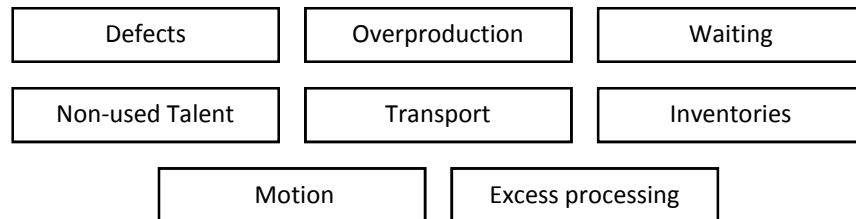

**Mura:** Mura is a Japanese word that signifies unevenness, non-uniformity, or irregularity. Mura is the reason for any of the seven wastes to exist. Mura, in other terms, is the one who drives and leads Muda. The purpose of a Lean manufacturing system is to ensure that the workload is evenly distributed and that no waste accumulates. Mura can be avoided by using 'Kanban' systems and other pull-based tactics to minimize overproduction and surplus inventory. The key concept of a Just-In-Time system is delivering and producing the right part, at the right amount, and at the right time.

**Muri:** Muri is a Japanese word that implies "overburden," "beyond one's power," "excessiveness," "impossibility," or "reasonableness." Muri can be created by Mura or, in some situations, by removing too much Muda (trash) from the process. Muri can also occur when equipment or operators are used to execute a task with more than 100% capacity or in an unsustainable manner. Employee absenteeism, disease, and machine problems can all be caused by Muri over time. By creating work processes to properly distribute workload and not overburden any individual employee or piece of equipment, standardize work can help reduce Muri.

### Heijunka

Variations in production volume lead to waste. The workload must be leveled; volume and variety must be averaged to achieve a steady flow of work. You can stop creating work in batches and start processing orders based on consumer demand by deploying Heijunka. You'll be able to lower your inventory costs because you'll have less things in reserve waiting to be purchased when order volume is low.

### Kaizen

Continuous improvement of the system. There is always room for improvement, so this effort must be ongoing. Kaizen is based on the philosophical belief that everything can be improved. With this approach, incremental changes add up to substantial changes over the longer term, without the need for radical innovation.

Kaizen is known for following benefits:

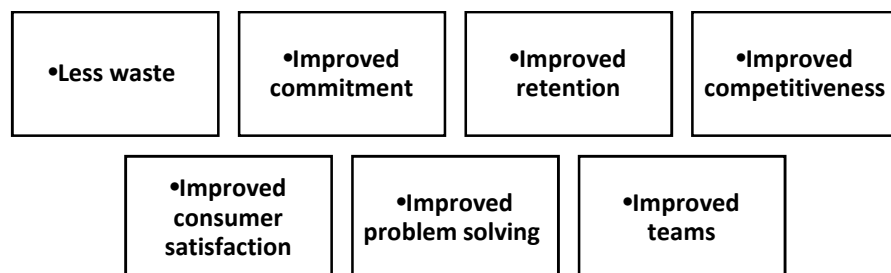

### Jidoka

The wellspring of quality. Autonomy is another term for it. Jidoka is a lean manufacturing principle in which machines stop functioning automatically when an abnormal state is detected, and operators try to remedy the defect to avoid it from happening again. It works on following four principles:

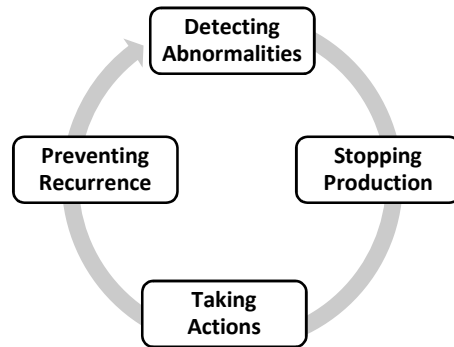

### 9.3 Goals and Building Blocks of Lean Systems

Lean system overall goal is to have a balanced and rapid flow. Lot of variables affect supply and demand. A commonly adopted practice is to have a buffer which can compensate variation in demand. Another approach is to match the demand with outsourcing. In either case, cost implications exist in addition to the overall impact on employees and the system.

Overall goal of lean system can be divided into three supporting goals:

- Elimination of disruptions
- Eliminating wastes
- Making system flexible

#### **Elimination of disruptions**

Disruptions have a negative impact on the system because they disrupt the steady flow of items through it, and they should be avoided at all costs. A variety of issues might create disruptions, including poor quality, equipment malfunctions, timetable changes, and late deliveries. Because there is no excess inventory in lean systems to replace damaged items, quality issues are extremely disruptive. Wherever possible, any disruptions should be avoided. This will lessen the amount of uncertainty the system has to deal with.

#### **Making system flexible**

A flexible system is one that is capable of handling a variety of goods on a daily basis, as well as fluctuations in output levels while maintaining balance and throughput speed. As a result, the system is able to cope with some uncertainty. Long setup durations and lead times have a negative impact on the system's adaptability. As a result, in a lean system, reducing setup and lead times is critical.

#### **Eliminating wastes**

Waste is a resource that isn't being used productively; decreasing waste can free up resources and increase productivity. Inventory is a squandering resource that takes up space and costs money. It should be kept as low as feasible.

Seven types of wastages are:

Inventory	•beyond minimal quantities, an idle resource, takes up floor space, and adds to cost.
Overproduction	•involves excessive use of manufacturing resources.
Waiting time	•requires space, adds no value.
Unnecessary transporting	•increases handling, increases work-in-process inventory.
Processing waste	•makes unnecessary production steps, scrap.
Inefficient work methods	•reduce productivity, increase scrap, increase work-in-process inventory.
Product defects	•require rework costs and possible lost sales due to customer dissatisfaction.

## 9.4 Building Blocks

The cornerstone for achieving the aforementioned goals is the design and operation of a lean system. Four building blocks are:

1. Product design.
2. Process design.
3. Personnel/organizational elements.
4. Manufacturing planning and control.

### 1. Product Design

Four elements of product design are:

#### Standard parts.

- Fewer parts to deal with
- Training times reduced
- Costs are reduced
- Purchasing, handling, and checking quality are more routine
- Ability to use standard processing.

#### Modular design

- Extension of standard parts
- Clusters of parts treated as a single unit
- Lesser number of parts to deal with
- Simplified assembly, purchasing, handling, training
- Standardization results in simplified bill of material

#### Highly capable production systems with quality built in

- Lean requires highly capable production systems.
- Quality must be embedded in goods and processes.
- The systems are geared to a smooth flow of work
- Avoid shutdowns and to quickly resolve problems when they do appear.
- Product design and process design must go hand in hand

#### Concurrent engineering

Concurrent engineering, also known as simultaneous engineering, is a process of product design and development in which the various stages are carried out in parallel rather than sequentially. It reduces the time it takes to design a product as well as the time it takes to get it to market, resulting in increased production and lower costs.

## 2. Process Design

Eight aspects are covered under process design:

### 1. Small lot sizes

Smaller lot size gives following advantage:

- Reduced carrying costs, space requirements, and clutter in the workplace
- Inspection and rework costs are less when problems with quality occur
- Fewer items in a lot to inspect and rework
- Greater flexibility in scheduling
- Repetitive systems produce a small variety of products

### 2. Setup time reduction

Small batches and constantly changing product combinations necessitate regular setups. The time and expense of completing these tasks can be prohibitive unless they are quick and relatively inexpensive. Long setup durations need the storage of more goods than quick setup times. As a result, there is a strong focus on decreasing setup times.

With the development of the single-minute exchange of die (SMED) system for lowering changeover time, Shigeo Shingo made a significant contribution to lean operations. Simple and consistent setup tools and equipment, as well as setup methods, are required.

### 3. Manufacturing cells

Machines and tools for processing families of parts with comparable processing requirements are housed in many manufacturing cells. The cells are, in essence, highly specialized and productive production centers. Reduced changeover times, increased equipment utilization, and simplicity of cross-training operators are all advantages of manufacturing cells.

### 4. Quality improvement

The occurrence of quality flaws during the process can cause the work to flow in an unorganized manner. Autonomy is sometimes used in lean production systems to reduce faults. Jidoka entails the automatic detection of flaws during the manufacturing process. It can be utilized in both automated and manual processes.

### 5. Production flexibility

A lean system's overall purpose is to be able to process a variety of products or services in a seamless flow. Bottlenecks, which occur when parts of the system get overwhelmed, are one potential stumbling block to this goal. The presence of bottlenecks indicates a system's inflexibility. In a variety of ways, process design can boost production flexibility and eliminate bottlenecks.

### 6. A balanced system

Line balancing (i.e., evenly distributing workload among workstations) aids in achieving a quick flow of work through the system. Work given to each workstation must be completed in less than or equal to the cycle time. The takt time is used to determine how long the cycle takes.

### 7. Little inventory storage.

Lean systems are created with the goal of reducing inventory storage. Carrying all that extra stuff costs a lot of money and takes up a lot of room, and it leaves problems unsolved. The lean method is to gradually reduce inventories in order to expose problems. Low inventories are the product of a successful problem-solving process that has taken place over time.

In a lean system, one option to reduce inventory storage is to have suppliers deliver directly to the production floor, eliminating the need to hold incoming parts and materials. Completed units are delivered out as soon as they are ready, reducing finished goods storage. These properties, when

combined with low work-in-process inventory, result in systems that function with extremely little inventory.

### **8. Fail-safe methods.**

Failsafing is the practice of incorporating safeguards into a process to limit or eliminate the possibility of errors occurring during the process. Shigeo Shingo's work, which actively pushed the use of Failsafing in operations, is credited with a large part of the credit for poka-yoke thinking. Some examples include password authentication for using computers, warning indicators in cars, designing power-plug to fit in a particular way.

## **3. Personnel/Organizational Elements**

The five elements are as followed:

### **1. Workers as assets**

Workers are assets, according to a core premise of the lean ideology. A lean system relies on well-trained and motivated employees. They have more decision-making authority than their counterparts in traditional systems, but they are also expected to do more.

### **2. Cross-trained workers**

Workers are cross-trained to perform many tasks and operate a wide range of machinery. This increases system flexibility by allowing workers to assist one another in the event of bottlenecks or when a teammate is absent. It also aids in the balance of lines.

### **3. Continuous improvement**

Workers in a lean system are expected to be more involved in problem resolution and continuous improvement than workers in traditional systems, and they are held more accountable for quality. Workers in the lean system are given comprehensive training in statistical process control, quality improvement, and problem-solving techniques.

A major concept of a truly lean approach is to work toward continuous system improvement—reducing inventories, lowering setup costs and time, improving quality, boosting output rate, and reducing waste and inefficiency in general.

### **4. Cost accounting**

Labor-intensive jobs (those that use a high proportion of direct labour) may be given a disproportionately high share of overhead, which does not accurately reflect true costs. As a result, managers are more likely to make incorrect decisions. Furthermore, keeping track of direct labour hours can be a time-consuming task in and of itself. Activity-based costing is an alternate approach of distributing overhead.

### **5. Leadership/project management.**

Managers are expected to be leaders and facilitators, not order givers. Lean encourages two-way communication between workers and managers.

## **4. Manufacturing Planning and Control**

Seven elements of manufacturing planning and control are:

- **Level loading.**

The goal of lean systems is to achieve stable, level daily mix schedules. In order to do this, a master production schedule is created to ensure level capacity loading. A smooth production schedule necessitates a level production schedule. The daily production requirements of each product or model are the starting point for mixed-model sequencing.

- **Pull systems**

Push and pull are phrases used to describe two alternative strategies for moving work through a manufacturing process. A push system is utilized in typical production environments: When a workstation's output is completed, it is pushed to the next station or, in the event of the last operation, to final inventory. In a pull system, on the other hand, the subsequent operation is in

charge of transferring the work; each workstation pulls the output from the preceding station as needed; the final operation's output is pulled by consumer demand or the master schedule.

- **Visual systems**

The "next-step demand" dictates the work flow in a pull system. A system can transmit such demand in a variety of ways, including a yell or a wave, but the kanban card is by far the most prevalent device. The Japanese word kanban means "signal" or "visible record." A kanban card is used by a worker who requires goods or labor from a previous station. The kanban card is, in effect, permission to move or work on parts.

- **Limited work-in-process (WIP)**

The kanban method and the continual work-in-process method are two common techniques to regulating WIP (CONWIP). WIP control in Kanban is focused on individual workstations, but WIP control in CONWIP is focused on the system as a whole. When a job quits the system in CONWIP, a new job is allowed to enter. As a result, the amount of work-in-progress remains constant.

- **Close vendor relationships**

Good vendor connections are critical in JIT purchasing. Buyers take steps to decrease the number of suppliers on their lists, focusing on maintaining close working relationships with a select few. Many customers try to find local vendors to cut delivery lead times and reduce lead time variability because they need frequent, modest deliveries.

Another benefit of having vendors close by is quick reaction time in the event of a crisis. Long-term connections between buyers and vendors help in JIT purchasing. Given a long-term connection, vendors are more inclined to commit resources to shipping according to a buyer's JIT method. Furthermore, price frequently takes a back seat to other aspects of the partnership.

- **Reduced transaction processing.**

Traditional manufacturing systems often have many built-in transactions that do not add value.

**Logistical transactions:** The ordering, execution, and confirmation of commodities transported from one site to another are all examples of logistical transactions. Personnel for shipping and receiving, expediting orders, data entry, and data processing are all included in the costs.

**Balancing transactions:** Forecasting, production planning, production control, procurement, scheduling, and order processing are all examples of balancing transactions. Personnel costs for these and related tasks are included in the associated costs.

**Quality transactions:** Determining and communicating standards, as well as monitoring, documenting, and follow-up operations, are all part of quality transactions. Internal failures (e.g., scrap, rework, retesting, delays, administration activities) and external failures (e.g., scrap, rework, retesting, delays, administration activities) are all included in the costs (e.g., warranty costs, product liability, returns, potential loss of future business).

**Change transactions:** Engineering modifications and the resulting changes in specifications, bills of materials, scheduling, processing instructions, and so on are the most common types of change transactions.

- **Preventive maintenance and housekeeping.**

Companies utilize preventative maintenance programs to reduce breakdowns by focusing on keeping equipment in good working order and replacing parts that have a tendency to fail before they fail. Workers are frequently responsible for their own equipment maintenance.

Even with preventive maintenance, equipment breakdowns will occur on occasion. Companies must be prepared for this so that they can rapidly restore service to their equipment. This could entail keeping important spare parts on hand and implementing other emergency preparations, such as keeping a small repair team on hand or teaching staff to perform some repairs themselves.

## Summary

- Lean is a concept and a practice that focuses on reducing waste (non-value-added tasks) and streamlining operations by synchronizing all activities closely.

- Because of their highly coordinated activities and timely delivery of goods, lean systems are also referred to as just-in-time (JIT) systems.
- The overall goal of the lean system can be broken down into three sub-goals: Disruption elimination, waste elimination, and system flexibility
- Many of the methods used in lean operations were developed as part of Toyota's manufacturing strategy.
- A balanced system, or one that accomplishes a smooth, quick flow of materials and/or work through the system, is the ultimate goal of lean.

### Keywords

- **Just-in-time (JIT)** smoothing the flow of material to arrive just as it is needed; evolved into a system for eliminating waste.
- **poka-yoke** any foolproof device or mechanism that prevents defects from occurring.
- **lean production** both a philosophy and an integrated system of management that emphasizes the elimination of waste and the continuous improvement of operations.
- **Muda** anything other than the minimum amount of equipment, materials, parts, space, and time that are absolutely essential to add value to the product.
- **pull system** a production system in which items are manufactured only when called for by the users of those items.
- **push system** a production system in which items are manufactured according to a schedule prepared in advance.

### Self Assessment

1. JIT was successfully implemented by
  - A. Toyota
  - B. Honda
  - C. Suzuki
  - D. Volkswagen
  
2. In JIT system
  - A. There is no delay
  - B. Conveyance times are balanced
  - C. Both a and b
  - D. There is unequal production at different places
  
3. In JIT the vendor is to be viewed by the company as a
  - A. Manager
  - B. Worker
  - C. Partner
  - D. None of the above
  
4. JIT is
  - A. Single unit production

- 
- B. Big lot size production
  - C. Both a and b
  - D. None of the above
- 
5. JIT does not believe in
    - A. Quality
    - B. Over production
    - C. Human relations
    - D. All of the above
- 
6. JIT combines the benefits of
    - A. Job order production and line production
    - B. Job order production and batch production
    - C. Batch production and line production
    - D. None of the above
- 
7. JIT aimed at
    - A. Zero inventories
    - B. Reduced manpower
    - C. Over production
    - D. All of the above
- 
8. The following is(are) the prerequisites for JIT
    - A. Multi skilled workers
    - B. Vendor should produce defect free
    - C. Worker should be empowered by his own decision
    - D. All of the above
- 
9. MRP is different from JIT in terms of
    - A. Inventory
    - B. Quality
    - C. Human orientation
    - D. All of the above
- 
10. A JIT production system would not include an emphasis on
    - A. The quantity of individual output
    - B. Producing products as needed by the next stage
    - C. Decentralization of support services
    - D. a and b
- 
11. Which of the following is not related with JIT implementation?
    - A. Pull System
    - B. Push System



- C. Zero inventory  
D. Zero lead time
12. MRP is a \_\_\_\_ system and JIT is a \_\_\_\_ system.  
A. Pull, pull  
B. Push, push  
C. Push, pull  
D. Pull, push
13. Which of the following are not results of successful implementation of JIT?  
A. Improved quality  
B. Sporadic improvement of productivity  
C. Elimination of waste  
D. Reduction in cost of operations
14. Which of the following is not a principle of JIT manufacturing?  
A. Total Quality Management  
B. Production Management  
C. MRP  
D. Supplier Management
15. Which of the following is not a benefit of JIT?  
A. Reduction in throughput time  
B. Improvement in quality  
C. Improvement in productivity  
D. High reliance on suppliers

**Answers for Self Assessment**

1. A      2. C      3. C      4. A      5. B  
6. A      7. A      8. D      9. D      10. A  
11. B      12. C      13. B      14. C      15. D

**Review Questions**

1. Differentiate between a push and a pull production system.
2. What trade-offs are involved in shifting from a traditional operations system to a lean system for:
  - a. A manufacturing firm?
  - b. A service firm?

3. What is the ultimate goal of a lean system? What are the supporting goals? What are the building blocks?
4. What are some of the main obstacles that must be overcome in converting from a traditional system to lean?
5. Briefly discuss vendor relations in lean systems in terms of the following issues:
  - a. Why are they important?
  - b. How do they tend to differ from the more adversarial relations of the past?
  - c. Why might suppliers be hesitant about JIT purchasing?
6. Compare and contrast the philosophy of traditional and JIT manufacturing. What are their objectives? How do they achieve them?
7. Explain the role of people in JIT. What is the meaning of *empowerment of workers* in JIT?
8. Explain the relationship between capacity utilization and manufacturing lead times.
9. List and explain the prerequisites of JIT manufacturing. Briefly explain why each is a prerequisite.
10. In recent years, many service organizations have adopted some of the techniques of JIT in order to achieve reduced waste, improved quality and shorter lead times. Explain such techniques.



### Further Readings

- Kiyoshi Suzuki, 1987, *The New Manufacturing Challenge: techniques for continuous improvement*, the Free Press, London.
- Yasuhiro Monden, 1993, *Toyota Production System: an integrated approach to Just-In Time*. Second edition, Industrial Engineering and Management Press, Institute of Industrial Engineers, Norcross, Georgia.
- Cheng TCE and Podolsky S, 1993, *Just-in-Time Manufacturing - an introduction*, Chapman and Hall, London.



### Web Links

- Kanban system in operations management  
<https://study.com/academy/lesson/kanban-system-in-operations-management.html>
- What is Poka Yoke technique  
<https://kanbanize.com/lean-management/improvement/what-is-poka-yoke>

## Unit 10: Linear Programming

### CONTENTS

Objectives

Introduction

10.1 Formulation of LPP

10.2 LPP Applications

10.3 Mathematical Model of LPP

10.4 Examples of LPP Formulation

10.5 Graphical Solution for LPP

10.6 LPP Simplex Solution

10.7 LPP solution by Simplex Big-M method

Summary

Keywords

Self Assessment

Answers for Self Assessment

Review Questions

Further Readings

### Objectives

After studying this unit, you will be able to:

- Understand concept of linear programming
- Formulate linear programming problem
- Find optimum solution for LPP through graphical method, simplex method, and simplex Big-M method

### Introduction

The word linear refers to linear relationship among variables in a model. For any change in one variable, proportional change caused in another variable. For example, doubling the salary of employees, engaged in a certain project, may increase output by two folds. The word programming refers to the mathematical modeling and solving of a problem that involves the use of limited resources, by choosing a particular strategy among the given strategies, in order to achieve the desired objective

Linear Programming is a mathematical technique useful for allocation of 'scarce' or 'limited' resources, to several competing activities on the basis of a given criterion of optimality.

A linear programming problem (LPP) consists of linear constraints and objective function, which is to be optimized. In this regard, initially two variable linear programming models are considered to understand the problem and investigated through the graphical method. The beauty of the graphical method is that it can give a clear picture to understand the nature of the problem as well as its solutions. Then the idea of a two-variable LPP is generalized into  $n$  number of variables that are solved by various techniques.

## 10.1 Formulation of LPP

Model formulation is the process of transforming a real word decision problem into an **operations research model**. Linear programming problem (LPP) comprises of following parts:

### Decision variables

Decision variables are the variables representing availability of different resources. These resources are linked with activities, represented by  $X_1, X_2, \dots, X_n$  in LPP. The value of these variables (activities) represents the extent to which each of these is performed. The value of certain variables may or may not be under the decision-maker's control. If values are under the control of the decision-maker, then such variables are said to be controllable, otherwise they are said to be uncontrollable.

### Objective function

The objective function of each LP problem is expressed in terms of decision variables to optimize the criterion of optimality such as profit, cost, revenue, distance etc. In its general form, it is represented as:

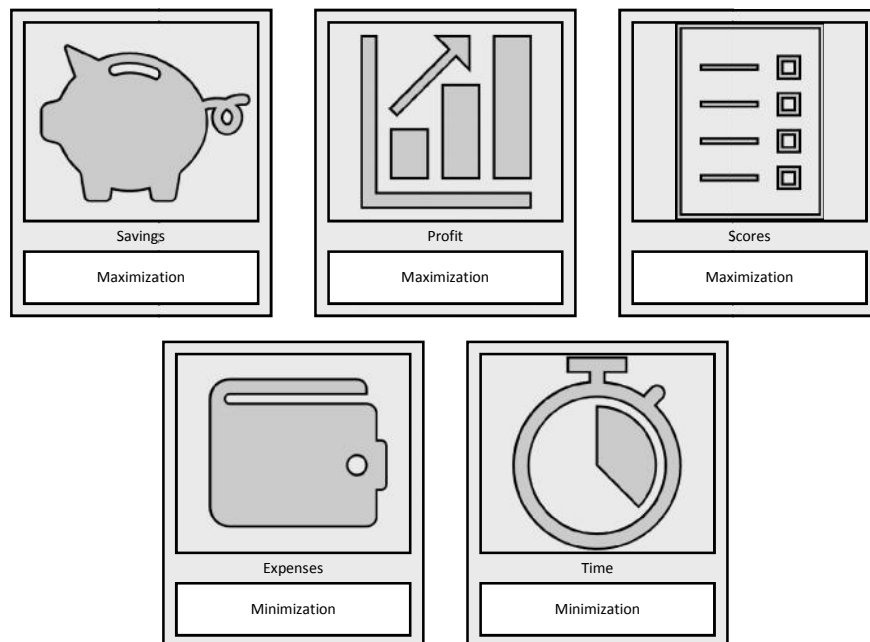

$$\text{Optimize (Maximize or Minimize) } Z = C_1X_1 + C_2 X_2 + \dots + C_nX_n,$$

This can be of minimization or maximization type



### The constraints

There are always certain limitations (or constraints) on the use of resources, such as: labor, machine, raw material, space, money, etc., that limit the degree to which an objective can be achieved. Such constraints must be expressed as linear equalities or inequalities in terms of decision variables. The solution of an LP model must satisfy these constraints. Some of the examples are shown below:

Labors	Machines	Raw Material
		
<input type="checkbox"/> Operation hours	<input type="checkbox"/> Operation hours	<input type="checkbox"/> Availability
<input type="checkbox"/> Availability	<input type="checkbox"/> Number of machines	<input type="checkbox"/> Grade
<input type="checkbox"/> Category	<input type="checkbox"/> Input/output type	<input type="checkbox"/> Assembly
<input type="checkbox"/> Efficiency	<input type="checkbox"/> Efficiency	

## 10.2 LPP Applications

LPP is used in many fields. Some of the common applications are:

- Agriculture
  - Farm economics
  - Farm management
- Military
  - Weapon selection
  - Efficient fuel utilization
  - Efficient weapon damage rate
- Production management
  - Product matrix
  - Production planning
  - Assembly-line balancing
  - Blending problems
  - Trim loss
- Financial management
  - Portfolio selection
  - Profit planning
- Marketing management
  - Media selection
  - Travelling salesman problem
  - Physical distribution
- Personnel Management
  - Staffing problem
  - Salary calculations
  - Selection process

## 10.3 Mathematical Model of LPP

For any linear model with  $n$  decision variable and  $m$  constraints, LPP is represented as:

Objective Function:

Linear Constraints

$$\sum_{j=1}^n a_{ij} x_j (\leq, =, \geq) b_i; \quad i = 1, 2, \dots, m$$

$$x_j \geq 0; \quad j = 1, 2, \dots, n$$

Where,

- The  $c_j$  s are coefficients representing the per unit profit (or cost) of decision variable  $x_j$  to the value of objective function.
- The  $a_{ij}$ 's are referred as technological coefficients. These coefficients can be positive, negative or zero.
- The  $b_i$  represents the total availability of the  $i^{\text{th}}$  resource.

LP problem, the expression ( $\leq, =, \geq$ ) means that in any specific problem each constraint may take only one of the three possible forms: (i) less than or equal to ( $\leq$ ) (ii) equal to ( $=$ ) (iii) greater than or equal to ( $\geq$ )

**Steps in LPP formulation:**

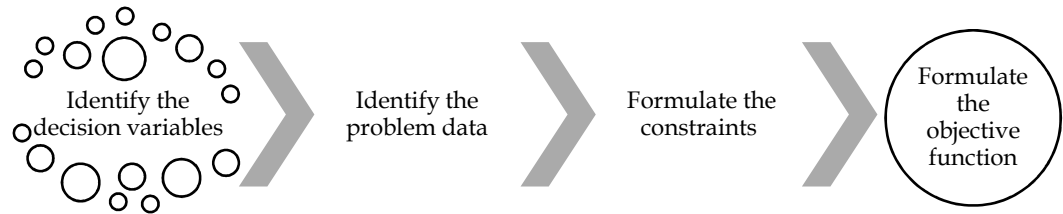

### 10.4 Examples of LPP Formulation

LPP formulation is done in a similar fashion across different industries. Some of the examples are as followed:



**Example 1:** A tire manufacturer produce three type of tires A, B & C. Raw material supply is sufficient to make 50 units of A, 30 units of B and 40 units of C. Daily 200 man-hours are permitted. A, B and C contributes 20, 30 & 50 Rs. profit per unit of production and takes 1, 2 and 2 hrs machine time per unit. Daily commitment is 20 units each for A, B & C. Manager is trying to maximize profit.

**Solution:**

1. Identify the decision variables

Units of tires manufactured of type A, B and C

Let number of units of tires A, B and C manufactured be:  $x_a$ ,  $x_b$  and  $x_c$

2. Identify the problem data

Product Type	Units manufactured	Raw material (Max.)	Profit per unit (Rs.)	Machine time per unit (Hrs.)	Target (Min. Units)
A	$x_a$	50	20	1	20
B	$x_b$	30	30	2	20
C	$x_c$	40	50	2	20
Limit			Maximize	Max. 200	

3. Formulate the constraints

- Raw material availability

- $X_a \leq 50$
- $X_b \leq 30$
- $X_c \leq 40$

- Target Requirement

- $X_a \geq 20$
- $X_b \geq 20$
- $X_c \geq 20$

- Labor Hours available

- $X_a + 2 \cdot X_b + 2 \cdot X_c \leq 200$

4. Formulate the objective function

- Maximize Profit = Max. Profit (from A + from B + from C)

- $\text{Max. } Z (\text{Profit}) = 20 X_a + 30 X_b + 50 X_c \leq 200$



**Example 2:** Accompany wishes to advertise on three different media: television, radio and a magazine. The objective is to reach as many potential customers as possible. The following are the results of a market study:

	Prime Day Television	Prime Time Television	Radio	Magazine
Advertisement cost ('000 Rs.)	40	75	30	15
Expected customers (Lks.)/ unit	4	9	5	2
Expected women customers (Lks.)/ unit	3	4	2	1

Some of the decisions of executive team are:

- Spending should be less than Rs. 8 Lks.
- Exposure to women should be at least 20 Lks.
- Cost of advertisement on television should be limited to Rs.5 Lks
- At least 3 advertisements during prime day
- At least 2 advertisements during prime time
- Number of advertisements on radio and magazine should each be at least 5 but not more than 10 each.

**Solution:**

Let  $x_1$ ,  $x_2$ ,  $x_3$  and  $x_4$  = number of advertising in prime day and time on television, radio and magazine, respectively.

**Objective Function:**

$$\text{Max. Reach} :: \quad \text{Maximize } Z = 4,00,000x_1 + 9,00,000x_2 + 5,00,000x_3 + 2,00,000x_4$$

**Constraints:**

**Budget:**

$$40,000x_1 + 75,000x_2 + 30,000x_3 + 15,000x_4 \leq 8,00,000$$

$$\text{Reach-women} :: \quad 3,00,000x_1 + 4,00,000x_2 + 2,00,000x_3 + 1,00,000x_4 \geq 20,00,000$$

$$\text{Television Ad:} \quad 40,000x_1 + 75,000x_2 \leq 5,00,000$$

$$x_1 \geq 3$$

$$x_2 \geq 2$$

$$\text{Radio \& magazine Ad:} \quad 5 \leq x_3 \leq 10$$

$$5 \leq x_4 \leq 10$$

## 10.5 Graphical Solution for LPP

Graphical solution is possible for an LPP where two variables are present. On graph, each axis represents a variable. Different constraints are represented as lines and associated area. Objective function is represented as a set of lines representing combination of both variables. In order to get maximized or minimized condition, common area represented by constraints, is considered. All points within this area represent possible solution for the LPP.

Corners of common area are checked with objective function. Point satisfying objective condition is the solution of LPP. Steps to solve LPP are as followed:

- Develop an LP model
- Replace the inequality sign in each constraint by an equality sign.

- Draw these straight lines on the graph paper and based on inequality signs, decide the area of feasible solutions.
- The final shaded area is called the feasible region.
- Determine the coordinates of each extreme point of the feasible solution area
- Compare the value of the objective function at each extreme point
- Identify the extreme point that gives desired (max. or min.) value of the objective function



Example:

$$\text{MAX } Z_x = 3x_1 + 2x_2$$

subject to

$$5x_1 + x_2 \geq 10$$

$$x_1 + x_2 \geq 6$$

$$x_1 + 4x_2 \geq 12$$

$$2x_1 + 3x_2 \leq 18$$

$$\text{and } x_1, x_2 \geq 0;$$

1. To draw constraint  $5x_1 + x_2 \geq 10 \rightarrow (1)$

Treat it as  $5x_1 + x_2 = 10$

When  $x_1 = 0$  then  $x_2 = ?$

$$\Rightarrow 5(0) + x_2 = 10$$

$$\Rightarrow x_2 = 10$$

When  $x_2 = 0$  then  $x_1 = ?$

$$\Rightarrow 5x_1 + (0) = 10$$

$$\Rightarrow 5x_1 = 10$$

$$\Rightarrow x_1 = \frac{10}{5} = 2$$

$x_1$	0	2
$x_2$	10	0

2. To draw constraint  $x_1 + x_2 \geq 6 \rightarrow (2)$

Treat it as  $x_1 + x_2 = 6$

When  $x_1 = 0$  then  $x_2 = ?$

$$\Rightarrow (0) + x_2 = 6$$

$$\Rightarrow x_2 = 6$$

When  $x_2 = 0$  then  $x_1 = ?$

$$\Rightarrow x_1 + (0) = 6$$

$$\Rightarrow x_1 = 6$$

$x_1$	0	6
$x_2$	6	0



## Unit 10: Linear Programming

3. To draw constraint  $x_1 + 4x_2 \geq 12 \rightarrow (3)$

Treat it as  $x_1 + 4x_2 = 12$

When  $x_1 = 0$  then  $x_2 = ?$

$$\Rightarrow (0) + 4x_2 = 12$$

$$\Rightarrow 4x_2 = 12$$

$$\Rightarrow x_2 = \frac{12}{4} = 3$$

When  $x_2 = 0$  then  $x_1 = ?$

$$\Rightarrow x_1 + 4(0) = 12$$

$$\Rightarrow x_1 = 12$$

$x_1$	0	12
$x_2$	3	0

4. To draw constraint  $2x_1 + 3x_2 \leq 18 \rightarrow (4)$

Treat it as  $2x_1 + 3x_2 = 18$

When  $x_1 = 0$  then  $x_2 = ?$

$$\Rightarrow 2(0) + 3x_2 = 18$$

$$\Rightarrow 3x_2 = 18$$

$$\Rightarrow x_2 = \frac{18}{3} = 6$$

When  $x_2 = 0$  then  $x_1 = ?$

$$\Rightarrow 2x_1 + 3(0) = 18$$

$$\Rightarrow 2x_1 = 18$$

$$\Rightarrow x_1 = \frac{18}{2} = 9$$

$x_1$	0	9
$x_2$	6	0

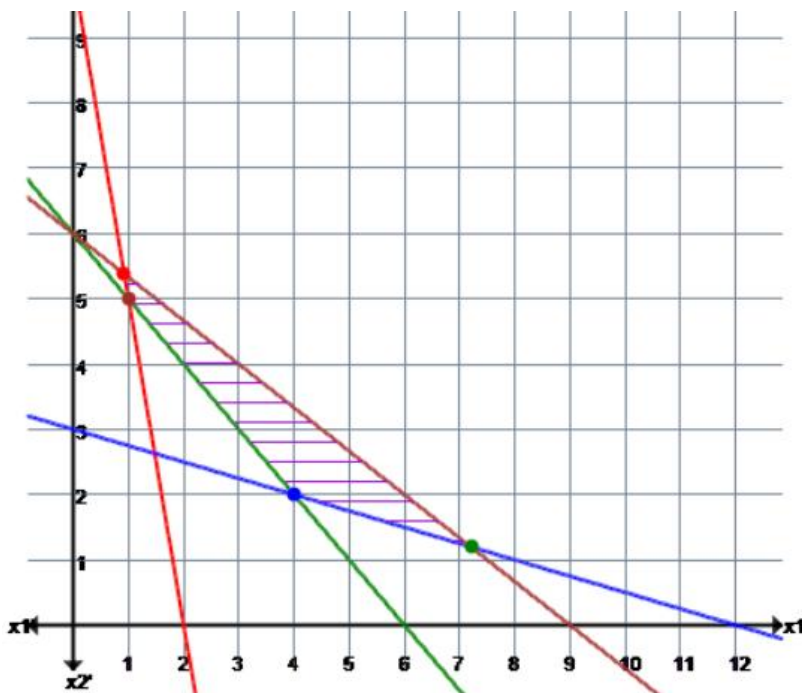

Objective function value  
 $Z = 3x_1 + 2x_2$

$$3\left(\frac{12}{13}\right) + 2\left(\frac{70}{13}\right) = \frac{176}{13}$$

$$3\left(\frac{36}{5}\right) + 2\left(\frac{6}{5}\right) = 24$$

$$3(4) + 2(2) = 16$$

$$3(1) + 2(5) = 13$$

The maximum value of the objective function  $Z = 24$  occurs at the extreme point  $\left(\frac{36}{5}, \frac{6}{5}\right)$ .

Hence, the optimal solution to the given LP problem is :  $x_1 = \frac{36}{5}, x_2 = \frac{6}{5}$  and  $\max Z = 24$ .

## 10.6 LPP Simplex Solution

Most real-life problems when formulated as an LP model have more than two variables and therefore need a more efficient method to suggest an optimal solution for such problems. The concept of simplex method is similar to the graphical method.

- In the graphical method, extreme points of the feasible solution space are examined in order to search for the optimal solution that lies at one of these points.
- For LP problems with several variables, we may not be able to graph the feasible region.
- The optimal solution will still lie at an extreme point of the many-sided, multidimensional figure that represents the feasible solution space.
- The simplex method examines these extreme points in a systematic manner, repeating the same set of steps of the algorithm until an optimal solution is found.

### LPP Standard form

LPP standard format has following characteristics:

- All the constraints should be expressed as equations by adding slack or surplus and/or artificial variables.
- The right-hand side of each constraint should be made non-negative (if not) by multiplying both sides of the resulting constraint by  $-1$
- The objective function should be of the maximization type.

The standard form of the LP problem is expressed as:

$$\text{Optimize (Max or Min) } Z = c_1x_1 + c_2x_2 + \dots + c_nx_n + 0s_1 + 0s_2 + \dots + 0s_m$$

subject to the linear constraints

$$a_{11}x_1 + a_{12}x_2 + \dots + a_{1n}x_n + s_1 = b_1$$

$$a_{21}x_1 + a_{22}x_2 + \dots + a_{2n}x_n + s_2 = b_2$$

$$\vdots$$

$$a_{m1}x_1 + a_{m2}x_2 + \dots + a_{mn}x_n + s_m = b_m$$

and  $x_1, x_2, \dots, x_n, s_1, s_2, \dots, s_m \geq 0$

Steps:

- Formulation of the mathematical model
- Set-up the initial solution
- Test for optimality
- Select the variable to enter the basis
- Test for feasibility (variable to leave the basis)
- Finding the new solution
- Repeat the procedure

### Flow Chart

Simplex LPP follows following flowchart:

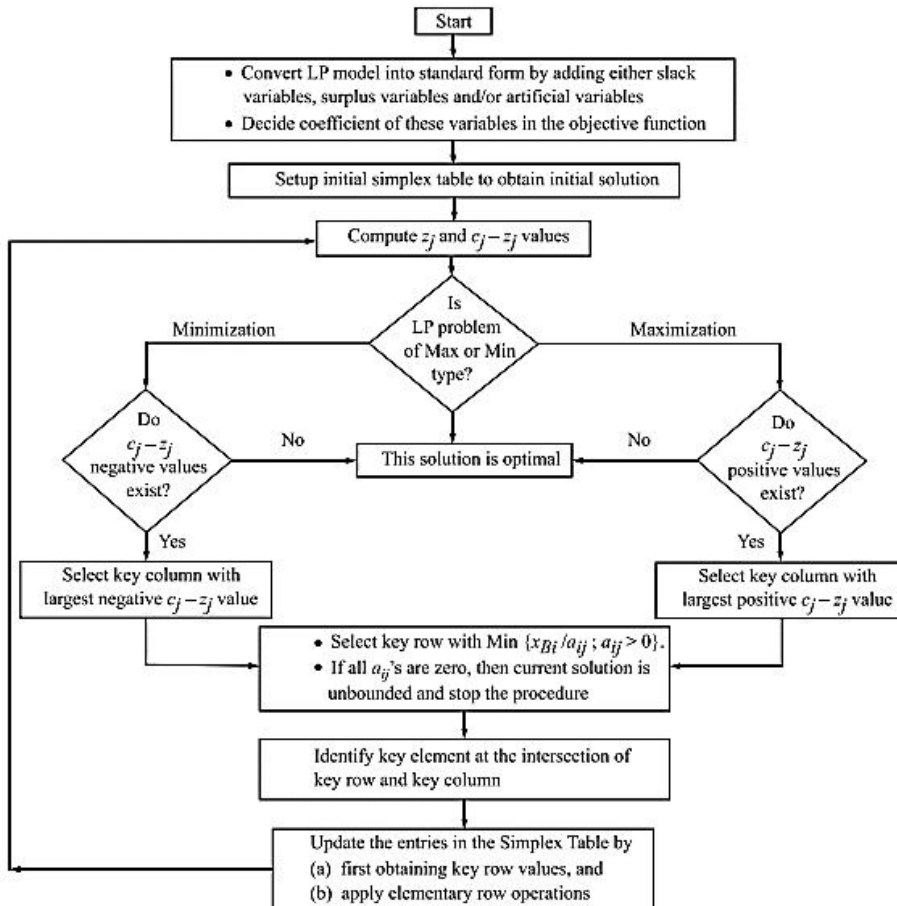

### Example:

Solve following LPP using simple method:

$$\text{Max } Z = 3x_1 + 5x_2 + 4x_3$$

subject to

$$2x_1 + 3x_2 \leq 8$$

$$2x_2 + 5x_3 \leq 10$$

$$3x_1 + 2x_2 + 4x_3 \leq 15$$

$$\text{and } x_1, x_2, x_3 \geq 0;$$

### Operations Management and Research

The problem is converted to canonical form by adding slack, surplus and artificial variables as appropriate

1. As the constraint-1 is of type ' $\leq$ ' we should add slack variable  $S_1$
2. As the constraint-2 is of type ' $\leq$ ' we should add slack variable  $S_2$
3. As the constraint-3 is of type ' $\leq$ ' we should add slack variable  $S_3$

#### After introducing slack variables

$$\text{Max } Z = 3x_1 + 5x_2 + 4x_3 + 0S_1 + 0S_2 + 0S_3$$

subject to

$$2x_1 + 3x_2 + S_1 = 8$$

$$2x_2 + 5x_3 + S_2 = 10$$

$$3x_1 + 2x_2 + 4x_3 + S_3 = 15$$

$$\text{and } x_1, x_2, x_3, S_1, S_2, S_3 \geq 0$$

Iteration-1		$C_j$	3	5	4	0	0	0	
$B$	$C_B$	$X_B$	$x_1$	$x_2$	$x_3$	$S_1$	$S_2$	$S_3$	MinRatio $\frac{X_B}{x_2}$
$S_1$	0	8	2	(3)	0	1	0	0	$\frac{8}{3} = 2.6667 \rightarrow$
$S_2$	0	10	0	2	5	0	1	0	$\frac{10}{2} = 5$
$S_3$	0	15	3	2	4	0	0	1	$\frac{15}{2} = 7.5$
$Z = 0$		$Z_j$	0	0	0	0	0	0	
		$C_j - Z_j$	3	5 $\uparrow$	4	0	0	0	

Positive maximum  $C_j - Z_j$  is 5 and its column index is 2. So, the entering variable is  $x_2$ .

Minimum ratio is 2.6667 and its row index is 1. So, the leaving basis variable is  $S_1$ .

$\therefore$  The pivot element is 3.

Entering =  $x_2$ , Departing =  $S_1$ , Key Element = 3

$$+ R_1(\text{new}) = R_1(\text{old}) \div 3$$

$$+ R_2(\text{new}) = R_2(\text{old}) - 2R_1(\text{new})$$

$$+ R_3(\text{new}) = R_3(\text{old}) - 2R_1(\text{new})$$

Iteration-2		$C_j$	3	5	4	0	0	0	
$B$	$C_B$	$X_B$	$x_1$	$x_2$	$x_3$	$S_1$	$S_2$	$S_3$	MinRatio $\frac{X_B}{x_3}$
$x_2$	5	$\frac{8}{3}$	$\frac{2}{3}$	1	0	$\frac{1}{3}$	0	0	—
$S_2$	0	$\frac{14}{3}$	$-\frac{4}{3}$	0	(5)	$-\frac{2}{3}$	1	0	$\frac{14}{5} = \frac{14}{15} = 0.9333 \rightarrow$
$S_3$	0	$\frac{29}{3}$	$\frac{5}{3}$	0	4	$-\frac{2}{3}$	0	1	$\frac{29}{4} = \frac{29}{12} = 2.4167$
$Z = \frac{40}{3}$		$Z_j$	$\frac{10}{3}$	5	0	$\frac{5}{3}$	0	0	
		$C_j - Z_j$	$-\frac{1}{3}$	0	4 $\uparrow$	$-\frac{5}{3}$	0	0	

## Unit 10: Linear Programming

Positive maximum  $C_j - Z_j$  is 4 and its column index is 3. So, the entering variable is  $x_3$ .

Minimum ratio is 0.9333 and its row index is 2. So, the leaving basis variable is  $S_2$ .

∴ The pivot element is 5.

Entering =  $x_3$ , Departing =  $S_2$ , Key Element = 5

$$+ R_2(\text{new}) = R_2(\text{old}) \div 5$$

$$+ R_1(\text{new}) = R_1(\text{old})$$

$$+ R_3(\text{new}) = R_3(\text{old}) - 4R_2(\text{new})$$

Iteration-3		$C_j$	3	5	4	0	0	0	
$B$	$C_B$	$X_B$	$x_1$	$x_2$	$x_3$	$S_1$	$S_2$	$S_3$	Min Ratio $\frac{X_B}{x_1}$
$x_2$	5	$\frac{8}{3}$	$\frac{2}{3}$	1	0	$\frac{1}{3}$	0	0	$\frac{8}{3} \div \frac{2}{3} = 4$
$x_3$	4	$\frac{14}{15}$	$-\frac{4}{15}$	0	1	$-\frac{2}{15}$	$\frac{1}{5}$	0	—
$S_3$	0	$\frac{89}{15}$	$\left(\frac{41}{15}\right)$	0	0	$-\frac{2}{15}$	$-\frac{4}{5}$	1	$\frac{89}{15} \div \frac{41}{15} = \frac{89}{41} = 2.1707 \rightarrow$
$Z = \frac{256}{15}$		$Z_j$	$\frac{34}{15}$	5	4	$\frac{17}{15}$	$\frac{4}{5}$	0	
		$C_j - Z_j$	$\frac{11}{15} \uparrow$	0	0	$-\frac{17}{15}$	$-\frac{4}{5}$	0	

Positive maximum  $C_j - Z_j$  is  $\frac{11}{15}$  and its column index is 1. So, the entering variable is  $x_1$ .

Minimum ratio is 2.1707 and its row index is 3. So, the leaving basis variable is  $S_3$ .

∴ The pivot element is  $\frac{41}{15}$ .

Entering =  $x_1$ , Departing =  $S_3$ , Key Element =  $\frac{41}{15}$

$$+ R_3(\text{new}) = R_3(\text{old}) \times \frac{15}{41}$$

$$+ R_1(\text{new}) = R_1(\text{old}) - \frac{2}{3}R_3(\text{new})$$

$$+ R_2(\text{new}) = R_2(\text{old}) + \frac{4}{15}R_3(\text{new})$$

Iteration-4		$C_j$	3	5	4	0	0	0
$B$	$C_B$	$X_B$	$x_1$	$x_2$	$x_3$	$S_1$	$S_2$	$S_3$
$x_2$	5	$\frac{50}{41}$	0	1	0	$\frac{15}{41}$	$\frac{8}{41}$	$-\frac{10}{41}$
$x_3$	4	$\frac{62}{41}$	0	0	1	$-\frac{6}{41}$	$\frac{5}{41}$	$\frac{4}{41}$
$x_1$	3	$\frac{89}{41}$	1	0	0	$-\frac{2}{41}$	$-\frac{12}{41}$	$\frac{15}{41}$
$Z = \frac{765}{41}$		$Z_j$	3	5	4	$\frac{45}{41}$	$\frac{24}{41}$	$\frac{11}{41}$
		$C_j - Z_j$	0	0	0	$-\frac{45}{41}$	$-\frac{24}{41}$	$-\frac{11}{41}$

Since all  $C_j - Z_j \leq 0$

Hence, optimal solution is arrived with value of variables as :

$$x_1 = \frac{89}{41}, x_2 = \frac{50}{41}, x_3 = \frac{62}{41}$$

$$\text{Max } Z = \frac{765}{41}$$

## 10.7 LPP solution by Simplex Big-M method

Simplex can be solved using Big-M method. It is another method of removing artificial variables from the basis. Large undesirable coefficients to artificial variables are assigned. If the objective function  $Z$  is to be minimized, then a very large positive price (called penalty) is assigned to each artificial variable. Similarly, if  $Z$  is to be maximized, then a very large negative price (also called penalty) is assigned to each of these variables. This penalty is designated by  $-M$ , for a maximization problem, and  $+M$ , for a minimization problem, where  $M > 0$ .

### Steps for Big-M Simplex method

Big M method involves following steps:

- Express the LP problem in the standard form by adding slack variables, surplus variables and/or artificial variables.
- Assign a zero coefficient to both slack and surplus variables.
- Assign a very large coefficient  $+M$  (minimization case) and  $-M$  (maximization case) to artificial variable in the objective function.
- The initial basic feasible solution is obtained by assigning zero value to decision variables
- Calculate the values of  $c_j - z_j$  in last row of the simplex table and examine these values.
- If all  $c_j - z_j \geq 0$ , then the current basic feasible solution is optimal.
- If for a column,  $k$ ,  $c_k - z_k$  is most negative and all entries in this column are negative, then the problem has an unbounded optimal solution.
- If one or more  $c_j - z_j < 0$  (minimization case), then select the variable to enter into the basis (solution mix) with the largest negative  $c_j - z_j$  value (largest per unit reduction in the objective function value).
- Determine the key row and key element
- Continue with the procedure to update solution at each iteration till optimal solution is obtained.



### Example:

Use Big-M method to solve the following LPP:

$$\text{Minimize } Z = 5x_1 + 3x_2$$

## Unit 10: Linear Programming

Subject to the constraints,

1.  $2x_1 + 4x_2 \leq 12$ ,
  2.  $2x_1 + 2x_2 = 10$ ,
  3.  $5x_1 + 2x_2 \geq 10$
- and  $x_1, x_2 \geq 0$

**After introducing slack, surplus, artificial variables**

$$\text{Min } Z = 50x_1 + 30x_2 + 0S_1 + 0S_2 + MA_1 + MA_2$$

subject to

$$20x_1 + 40x_2 + S_1 = 120$$

$$20x_1 + 20x_2 + A_1 = 100$$

$$50x_1 + 20x_2 - S_2 + A_2 = 100$$

and  $x_1, x_2, S_1, S_2, A_1, A_2 \geq 0$

Iteration-1		$C_j$	50	30	0	0	$M$	$M$	
$B$	$C_B$	$X_B$	$x_1$	$x_2$	$S_1$	$S_2$	$A_1$	$A_2$	MinRatio $\frac{X_B}{x_1}$
$S_1$	0	120	20	40	1	0	0	0	$\frac{120}{20} = 6$
$A_1$	$M$	100	20	20	0	0	1	0	$\frac{100}{20} = 5$
$A_2$	$M$	100	(50)	20	0	-1	0	1	$\frac{100}{50} = 2 \rightarrow$
$Z = 200M$		$Z_j$	$70M$	$40M$	0	$-M$	$M$	$M$	
		$C_j - Z_j$	$-70M + 50 \uparrow$	$-40M + 30$	0	$M$	0	0	

Negative minimum  $C_j - Z_j$  is  $-70M + 50$  and its column index is 1. So, the entering variable is  $x_1$ .

Minimum ratio is 2 and its row index is 3. So, the leaving basis variable is  $A_2$ .

$\therefore$  The pivot element is 50.

Entering =  $x_1$ , Departing =  $A_2$ , Key Element = 50

$$+ R_3(\text{new}) = R_3(\text{old}) \div 50$$

$$+ R_1(\text{new}) = R_1(\text{old}) - 20R_3(\text{new})$$

$$+ R_2(\text{new}) = R_2(\text{old}) - 20R_3(\text{new})$$

Iteration-2		$C_j$	50	30	0	0	$M$	
$B$	$C_B$	$X_B$	$x_1$	$x_2$	$S_1$	$S_2$	$A_1$	MinRatio $\frac{X_B}{x_2}$
$S_1$	0	80	0	(32)	1	$\frac{2}{5}$	0	$\frac{80}{32} = 2.5 \rightarrow$
$A_1$	$M$	60	0	12	0	$\frac{2}{5}$	1	$\frac{60}{12} = 5$
$x_1$	50	2	1	$\frac{2}{5}$	0	$-\frac{1}{50}$	0	$\frac{2}{\frac{2}{5}} = 5$
$Z = 60M + 100$		$Z_j$	50	$12M + 20$	0	$\frac{2M}{5} - 1$	$M$	
		$C_j - Z_j$	0	$-12M + 10 \uparrow$	0	$-\frac{2M}{5} + 1$	0	

*Operations Management and Research*

---

Negative minimum  $C_j - Z_j$  is  $-12M + 10$  and its column index is 2. So, the entering variable is  $x_2$ .

Minimum ratio is 2.5 and its row index is 1. So, the leaving basis variable is  $S_1$ .

∴ The pivot element is 32.

Entering =  $x_2$ , Departing =  $S_1$ , Key Element = 32

$$+ R_1(\text{new}) = R_1(\text{old}) \div 32$$

$$+ R_2(\text{new}) = R_2(\text{old}) - 12R_1(\text{new})$$

$$+ R_3(\text{new}) = R_3(\text{old}) - \frac{2}{5}R_1(\text{new})$$

Iteration-3		$C_j$	50	30	0	0	$M$	
$B$	$C_B$	$X_B$	$x_1$	$x_2$	$S_1$	$S_2$	$A_1$	MinRatio $\frac{X_B}{S_2}$
$x_2$	30	$\frac{5}{2}$	0	1	$\frac{1}{32}$	$\frac{1}{80}$	0	$\frac{5}{\frac{1}{80}} = 200$
$A_1$	$M$	30	0	0	$-\frac{3}{8}$	$\left(\frac{1}{4}\right)$	1	$\frac{30}{\frac{1}{4}} = 120 \rightarrow$
$x_1$	50	1	1	0	$-\frac{1}{80}$	$-\frac{1}{40}$	0	—
$Z = 30M + 125$		$Z_j$	50	30	$-\frac{3M}{8} + \frac{5}{16}$	$\frac{M}{4} - \frac{7}{8}$	$M$	
		$C_j - Z_j$	0	0	$\frac{3M}{8} - \frac{5}{16}$	$-\frac{M}{4} + \frac{7}{8} \uparrow$	0	

Negative minimum  $C_j - Z_j$  is  $-\frac{M}{4} + \frac{7}{8}$  and its column index is 4. So, the entering variable is  $S_2$ .

Minimum ratio is 120 and its row index is 2. So, the leaving basis variable is  $A_1$ .

∴ The pivot element is  $\frac{1}{4}$ .

Entering =  $S_2$ , Departing =  $A_1$ , Key Element =  $\frac{1}{4}$

$$+ R_2(\text{new}) = R_2(\text{old}) \times 4$$

$$+ R_1(\text{new}) = R_1(\text{old}) - \frac{1}{80}R_2(\text{new})$$

$$+ R_3(\text{new}) = R_3(\text{old}) + \frac{1}{40}R_2(\text{new})$$



## Unit 10: Linear Programming

Iteration-4		$C_j$	50	30	0	0
$B$	$C_B$	$X_B$	$x_1$	$x_2$	$S_1$	$S_2$
$x_2$	30	1	0	1	$\frac{1}{20}$	0
$S_2$	0	120	0	0	$-\frac{3}{2}$	1
$x_1$	50	4	1	0	$-\frac{1}{20}$	0
$Z = 230$		$Z_j$	50	30	-1	0
		$C_j - Z_j$	0	0	1	0

Since all  $C_j - Z_j \geq 0$

Hence, optimal solution is arrived with value of variables as :

$$x_1 = 4, x_2 = 1$$

$$\text{Min } Z = 230$$

## Summary

- Linear programming (LP) is a widely used mathematical modelling technique developed to help decision makers in planning and decision-making regarding optimal use of scarce resources
- A graphical method is used to reach an optimal solution to an LP problem that has a number of constraints binding the objective function.
- Both extreme point methods and the iso-profit (or cost) function line method are used for graphically solving any LP problem that has only two decision variables
- Simplex consists of a series of rules that, in effect, algebraically examine corner (extreme) points of the solution space in a systematic way.
- Each step in simplex moves towards the optimal solution by increasing profit or decreasing cost, while maintaining feasibility.

## Keywords

**Artificial Variable:**The artificial variable technique is a device to get the starting basic feasible solution, so that simplex procedure may be adopted as usual until the optimal solution is obtained.

**Constraints:**The linear inequalities or equations or restrictions on the variables of a linear programming problem are called constraints. The conditions  $x \geq 0, y \geq 0$  are called non-negative restrictions.

**LPP:**Linear programming or linear optimization is a process which takes into consideration certain linear relationships to obtain the best possible solution to a mathematical model. It is also denoted as LPP. It includes problems dealing with maximizing profits, minimizing costs, minimal usage of resources, etc. These problems can be solved through the simplex method or graphical method.

**Objective Function:**The objective function in linear programming problems is the real-valued function whose value is to be either minimized or maximized subject to the constraints defined on the given LPP over the set of feasible solutions.

**Slack Variable:**An additional variable that has been introduced to the optimization problem to turn an inequality constraint into an equality constraint

**Surplus Variable:**A variable which is subtracted from a constraint to turn the inequality into an equation. This is required to turn an inequality into an equality where a linear combination of variables is greater than or equal to a given constant in the former.

**SelfAssessment**

1. If  $a$  is number of students and  $b$  is number of teachers, which of the equations is not possible
  - A.  $a + b \geq 100$
  - B.  $a, b \geq 0$
  - C. Both are possible
  - D. Insufficient information
  
2. LPP deals with how many variables?
  - A. 0
  - B. 1
  - C. 2
  - D. 2 or more
  
3. Graphical solution of LPP is limited to \_\_\_\_ number of constraints.
  - A. 0
  - B. 1
  - C. 2
  - D. No Limit
  
4. What type of constraints are not considered in LPP problem?
  - A. With  $= <$
  - B. With  $\geq =$
  - C. Equality
  - D. All 3 types can be considered
  
5. Bounded area represented by LPP problem can give \_\_\_\_\_ number of solution(s).
  - A. 0
  - B. 1
  - C. 2
  - D. All of the above
  
6. Un-bounded area represented by LPP problem can give \_\_\_\_\_ number of solution(s).
  - A. 0
  - B. 1
  - C. 2
  - D. All of the above
  
7.  $2x + y \geq 10$  cuts x axis at:
  - A. 5
  - B. 10
  - C. 0
  - D. None of the above

8.  $2x+y \geq 10$  represents area including:
- A. Origin (0,0)
  - B. 4,2
  - C. 2,4
  - D. None of the above
9. Multiple solutions of LPP problem are possible when:
- A. One constraint is redundant
  - B. Objective function is parallel to one of the constraints
  - C. Two constraints are parallel
  - D. All the above
10. \_\_\_\_\_ is a linear function of variables which is maximized or minimized in LPP
- A. Constraints
  - B. Objective functions
  - C. Decision variable
  - D. None of the above
11. In \_\_\_\_\_ solution, value of objective function increases indefinitely by changing variables value
- A. Bounded
  - B. Unbounded
  - C. Finite
  - D. None of the above
12. Which of the following is/are assumption(s) in LPP?
- A. Divisibility
  - B. Proportionality
  - C. Both divisibility and proportionality
  - D. None of the above
13. LPP is used for:
- A. Fund management
  - B. Efficient manpower utilization
  - C. Optimum material utilization
  - D. All of the above is true
14. Artificial variables are used for \_\_\_\_\_ type of constraints
- A. " $\leq$ " type
  - B. " $\geq$ " type
  - C. "=" type
  - D. " $\geq$ " and "=" type

15. Which of the following is possible with LPP problem
- Can always be solved by both graphical and simplex method
  - Can always be solved by Simplex method
  - Can always be solved by graphical method
  - None of the above

### Answers for Self Assessment

- |       |       |       |       |       |
|-------|-------|-------|-------|-------|
| 1. C  | 2. D  | 3. D  | 4. D  | 5. D  |
| 6. D  | 7. A  | 8. B  | 9. D  | 10. B |
| 11. B | 12. C | 13. D | 14. D | 15. B |

### Review Questions

- Identify food items which are part of your daily diet. Find per unit contribution of fat, carbohydrate, and protein from these food items. Formulate LPP problem where these food items can help you attain 80% of your daily dietary requirement, but at the least cost possible.
- Review your spending and earning sources. Formulate an LPP problem where you can maximize your savings while meeting your monthly budget constraint.
- Find solution using graphical method

$$\text{MIN } z = 2x_1 + x_2$$

Subject to

$$x_1 + 2x_2 \leq 10$$

$$x_1 + x_2 \leq 6$$

$$x_1 - x_2 \leq 2$$

$$x_1 - 2x_2 \leq 1$$

$$\text{and } x_1, x_2 \geq 0$$

- Find solution using graphical method

$$\text{MIN } z = 4x_1 + 3x_2$$

Subject to

$$200x_1 + 100x_2 \geq 4000$$

$$x_1 + 2x_2 \geq 50$$

$$40x_1 + 40x_2 \geq 1400$$

$$\text{and } x_1, x_2 \geq 0$$

- Find solution using graphical method

$$\text{MAX } z = 2x_1 + x_2$$

Subject to

$$x_1 + 2x_2 \leq 10$$

$$x_1 + x_2 \geq 6$$

$$x_1 - x_2 \geq 2$$

$$x_1 - 2x_2 \geq 1$$

$$\text{And } x_1, x_2 \geq 0$$

6. Find solution using Simplex method

$$\text{MAX } Z = 3x_1 + 5x_2$$

Subject to

$$x_1 - 2x_2 \leq 6$$

$$x_1 \leq 10$$

$$x_2 \leq 1$$

$$\text{and } x_1, x_2 \geq 0$$

7. Find solution using Simplex method (BigM method)

$$\text{MAX } Z = x_1 + 2x_2 + 3x_3 - x_4$$

Subject to

$$x_1 + 2x_2 + 3x_3 \geq 15$$

$$2x_1 + x_2 + 5x_3 = 20$$

$$x_1 + 2x_2 + x_3 + x_4 = 10$$

$$\text{and } x_1, x_2, x_3, x_4 \geq 0$$

8. Find solution using Simplex method (BigM method)

$$\text{MIN } Z = 5x_1 + 10x_2 + 8x_3$$

Subject to

$$3x_1 + 5x_2 + 2x_3 \leq 60$$

$$4x_1 + 4x_2 + 4x_3 \geq 72$$

$$2x_1 + 4x_2 + 5x_3 = 100$$

$$\text{and } x_1, x_2, x_3 \geq 0$$



### Further Readings

- Operations Research, By Sivarethinamohan, McGraw-Hill Education (India) Pvt Limited
- Quantitative Techniques, Theory and Problems, By P. C. Tulsian, Pearson Education



### Web Links

- <https://www.geeksforgeeks.org/graphical-solution-of-linear-programming-problems/>
- <https://ncert.nic.in/ncerts/l/lemh206.pdf>
- <https://people.richland.edu/james/ictcm/2006/simplex.html>
- <http://www.universalteacherpublications.com/univ/ebooks/or/Ch3/mmethod.htm>



## Unit 11: Assignment and Transportation Problem

### CONTENTS

Objectives

Introduction

11.1 Transportation Problem

11.2 Transportation Model

11.3 Algorithm to Solve Transportation Problem

11.4 IFS with NWC Method

11.5 IFS with LCM Method

11.6 IFS with VAM Method

11.7 Test for Optimality

11.8 The Modified-distribution (MODI) method

11.9 Assignment Problem

11.10 Hungarian Method

Summary

Keywords

Self Assessment

Answers for Self Assessment

Review Questions

Further Readings

### Objectives

After studying this unit, you will be able to:

- Understand assignment and transportation problem.
- Solve assignment problem using Hungarian model. (HAM)
- Calculate initial feasible solution.
- Check optimality of transportation problem.
- Solve initial feasible solution to get optimum solution.

### Introduction

Linear programming is widely used to solve real life problems. These LPP problems deal with multiple variables and constraints. Some of the applications are in Logistics and material management. We might have a situation where we have multiple points to receive input and multiple points where these inputs need to be distributed. Multiple combinations of these sources can be identified. Situation is complex when each of this combination can take range of transportation units.

LPP can be formulated where optimum transportation quantities on each route may be calculated. Objective of least cost or maximum profit can be achieved through it. Transportation problem works on this logic and represents LPP in tabular format.

In some scenarios, quantity variation need not to be considered. Linking a task with performer, in most optimum way, might be desired. Thus, Transportation problem may be further restricted to optimum route identification. This special case is also referred as Assignment problem.

## 11.1 Transportation Problem

The transportation problem is a type of Linear Programming Problem (LPP) in which items are carried from a set of sources to a set of destinations, with the total cost of transportation reduced, based on the supply and demand of the sources and destinations, respectively. The traditional simplex method is not suitable for solving transportation problems due to its unique structure.

Transportation problem is solved in two stages. Basic feasible solution is calculated using methods like North-west corner method, Vogel's Approximation method or Least Cost Method. This solution might not be optimum. Methods like Stepping Stone or MODI method is used to find optimum solution.

## 11.2 Transportation Model

- **Sources and Destinations**

In transportation model, we have multiple sources, which may be represented by  $S_1, S_2, \dots, S_n$ .

Destinations may be represented by  $D_1, D_2, \dots, D_m$ .

- **Cost of Transportation**

Based on past experience and calculations, transportation cost on each route can be calculated as:

$C_{1.1}, C_{1.2}, \dots, C_{1.m}$

$C_{2.1}, C_{2.2}, \dots, C_{2.m}$

..

..

$C_{n.1}, C_{n.2}, \dots, C_{n.m}$

- **Total supply limit**

Supply distributed from a source to multiple destinations can't exceed total supply from source. This can be represented as:

$Q_{1.1} + Q_{1.2} + \dots + Q_{1.m} = Q_1$

$Q_{2.1} + Q_{2.2} + \dots + Q_{2.m} = Q_2$

...

...

$Q_{n.1} + Q_{n.2} + \dots + Q_{n.m} = Q_n$

- **Total Demand Limit**

Supply received from multiple sources can't exceed total demand at the destination. This can be represented as:

$Q_{1.1} + Q_{2.1} + \dots + Q_{n.1} = Q_{.1}$

$Q_{1.2} + Q_{2.2} + \dots + Q_{n.2} = Q_{.2}$

...

...

$Q_{1.m} + Q_{2.m} + \dots + Q_{n.m} = Q_{.m}$

- **Objective Function**

Objective of the allocation may be to allocate routes with minimum total cost

Minimize  $(Q_{1.1} * C_{1.1} + \dots + Q_{1.m} * C_{1.m} + \dots + Q_{n.m} * C_{n.m})$

- **Representation of Transportation Matrix**

Above constraints may be represented in tabular format as:



Unit 11: Assignment and Transportation Problem

		Demand			Total Supply
		D1	D2	D3	
Supply	S1	2	5	6	100
	S2	4	8	8	200
	S3	2	7	9	300
Total Demand		200	200	200	

**11.3 Algorithm to Solve Transportation Problem**

Following steps are taken to solve transportation problem:

**Step 1 – Formulation**

The transportation problem is comparable to the LP problem in terms of formulation. The total transportation cost is the objective function, and the constraints are the quantity of supply and demand available at each source and destination, respectively.

**Step 2 – Initial feasible solution**

Three different methods may be used for finding initial feasible solution (IFS). These methods are:

- A. North-west corner method (NWC method)
- B. Least Cost method (LCM)
- C. Vogel's approximation method (VAM)

IFS obtained from any of these methods should follow following conditions:

- A. Rim condition: The solution must be feasible, i.e. it must satisfy all the supply and demand constraints
- B. The number of positive allocations must be equal to  $m + n - 1$ , where  $m$  is the number of rows and  $n$  is the number of columns.

If the IFS satisfy the above conditions, it is called non-degenerate basic feasible solution, otherwise, degenerate solution.

**Step 3 – Test for Optimality**

Modified distribution (MODI) method or Stepping-Stone method can be used to check optimality. If solution is not optimal, algorithm can be used to improvise solution.

**11.4 IFS with NWC Method**

Following steps are taken:

Step 1	Start with the cell at the upper left (north-west) corner of the transportation table (or matrix) and allocate commodity equal to the minimum of the rim values for the first row and first column, i.e. $\min(a_1, b_1)$
--------	---

Step 2	If allocation made in Step 1 is equal to the supply available at first source (a1, in first row), then move vertically down to the cell (2, 1), i.e., second row and first column. Apply Step 1 again, for next allocation.	If allocation made in Step 1 is equal to the demand of the first destination (b1 in first column), then move horizontally to the cell (1, 2), i.e., first row and second column. Apply Step 1 again for next allocation.	If $a_1 = b_1$ , allocate $x_{11} = a_1$ or $b_1$ and move diagonally to the cell (2, 2)
Step 3	Continue the procedure step by step till an allocation is made in the south-east corner cell of the transportation table.		



**Example:** Find Solution using North-West Corner method

	D1	D2	D3	Supply
S1	11	13	17	250
S2	16	18	14	300
S3	21	24	13	400
Demand	200	225	275	

**Solution:**

TOTAL number of supply constraints : 3. TOTAL number of demand constraints : 3  
 Problem Table is

Here Total Demand = 700 is less than Total Supply = 950. So We add a dummy demand constraint with 0 unit cost and with allocation 250. Now, the modified table is:

	D1	D2	D3	Ddummy	Supply
S1	11	13	17	0	250
S2	16	18	14	0	300
S3	21	24	13	0	400
Demand	200	225	275	250	

The rim values for  $S_1=250$  and  $D_1=200$  are compared. The smaller of the two i.e.  $\min(250,200) = 200$  is assigned to  $S_1 D_1$ . This meets the complete demand of  $D_1$  and leaves  $250 - 200=50$  units with  $S_1$

	D1	D2	D3	Ddummy	Supply
S1	11(200)	13	17	0	50
S2	16	18	14	0	300
S3	21	24	13	0	400
Demand	0	225	275	250	

Unit 11: Assignment and Transportation Problem

The rim values for  $S_1=50$  and  $D_2=225$  are compared. The smaller of the two i.e.  $\min(50,225) = 50$  is assigned to  $S_1 D_2$ . This exhausts the capacity of  $S_1$  and leaves  $225 - 50=175$  units with  $D_2$

	D1	D2	D <sub>3</sub>	Ddummy	Supply
S1	11(20 0)	13(50)	17	0	0
S2	16	18	14	0	300
S3	21	24	13	0	400
Demand	0	175	27 5	250	

The rim values for  $S_2=300$  and  $D_2=175$  are compared. The smaller of the two i.e.  $\min(300,175) = 175$  is assigned to  $S_2 D_2$ . This meets the complete demand of  $D_2$  and leaves  $300 - 175=125$  units with  $S_2$

	D1	D2	D3	Ddummy	Supply
S1	11(200 )	13(50)	17	0	0
S2	16	18(175 )	14	0	125
S3	21	24	13	0	400
Demand	0	0	27 5	250	

The rim values for  $S_2=125$  and  $D_3=275$  are compared. The smaller of the two i.e.  $\min(125,275) = 125$  is assigned to  $S_2 D_3$ . This exhausts the capacity of  $S_2$  and leaves  $275 - 125=150$  units with  $D_3$

	D1	D2	D3	Ddummy	Supply
S1	11(200 )	13(50)	17	0	0
S2	16	18(175 )	14(125 )	0	0
S3	21	24	13	0	400
Demand	0	0	150	250	

The rim values for  $S_3=400$  and  $D_3=150$  are compared. The smaller of the two i.e.  $\min(400,150) = 150$  is assigned to  $S_3 D_3$ . This meets the complete demand of  $D_3$  and leaves  $400 - 150=250$  units with  $S_3$

	D1	D2	D3	Ddummy	Supply
S1	11(200 )	13(50)	17	0	0

S2	16	18(175)	14(125)	0	0
S3	21	24	13(150)	0	250
Demand	0	0	0	250	

The rim values for S3=250 and Ddummy = 250 are compared. The smaller of the two i.e. min (250,250) = 250 is assigned to S3 Ddummy

	D1	D2	D3	Ddummy	Supply
S1	11(200)	13(50)	17	0	0
S2	16	18(175)	14(125)	0	0
S3	21	24	13(150)	0(250)	0
Demand	0	0	0	0	

Initial feasible solution is

	D1	D2	D3	Ddummy	Supply
S1	11 (200)	13 (50)	17	0	250
S2	16	18 (175)	14 (125)	0	300
S3	21	24	13 (150)	0 (250)	400
Demand	200	225	275	250	

The minimum total transportation cost =  $11 \times 200 + 13 \times 50 + 18 \times 175 + 14 \times 125 + 13 \times 150 + 0 \times 250 = 9700$   
 Here, the number of allocated cells = 6 is equal to  $m + n - 1 = 3 + 4 - 1 = 6$   
 $\therefore$  this solution is non-degenerate

### 11.5 IFS with LCM Method

Since the primary goal is to reduce total transportation costs, transport as much as feasible via the routes (cells) with the lowest unit transportation costs. For getting the initial answer, this method considers the lowest unit cost of transportation. Steps are as followed:

**Step 1:** Select the cell with the lowest unit cost in the entire transportation table and allocate as much as possible to this cell. Then eliminate (line out) that row or column in which either the supply or demand is fulfilled. If a row and a column are both satisfied simultaneously, then crossed off either a row or a column. In case the smallest unit cost cell is not unique, then select the cell where the maximum allocation can be made.

---

**Unit 11: Assignment and Transportation Problem**

---

**Step 2:**After adjusting the supply and demand for all uncrossed rows and columns repeat the procedure to select a cell with the next lowest unit cost among the remaining rows and columns of the transportation table and allocate as much as possible to this cell. Then crossed off that row and column in which either supply or demand is exhausted.

**Step 3:**Repeat the procedure until the available supply at various sources and demand at various destinations is satisfied. The solution so obtained need not be non-degenerate

**Example:**Find Solution using LCM method

	D1	D2	D3	Supply
S1	11	13	17	250
S2	16	18	14	300
S3	21	24	13	400
Demand	200	225	275	

Solution:

Here Total Demand = 700 is less than Total Supply = 950. So we add a dummy demand constraint with 0 unit cost and with allocation 250. Now, the modified table is

	D1	D2	D3	Ddummy	Supply
S1	11	13	17	0	250
S2	16	18	14	0	300
S3	21	24	13	0	400
Demand	200	225	275	250	

**Here dummy column is used and method is LCM. So we first allocate cells except dummy column and at last step in dummy column**

the smallest transportation cost is 11 in cell S1D1.

The allocation to this cell is  $\min(250,200) = 200$ . This satisfies the entire demand of D1 and leaves  $250 - 200 = 50$  units with S1

	D1	D2	D3	Ddummy	Supply
S1	11( <b>200</b> )	13	17	0	50
S2	16	18	14	0	300
S3	21	24	13	0	400
Demand	0	225	275	250	

The smallest transportation cost is 13 in cell S3D3. The allocation to this cell is  $\min(400,275) = 275$ . This satisfies the entire demand of D3 and leaves  $400 - 275 = 125$  units with S3

	D1	D2	D3	Ddummy	Supply

*Operations Management and Research*

S1	11( <b>200</b> )	13	17	0	50
S2	16	18	14	0	300
S3	21	24	13( <b>275</b> )	0	125
Demand	0	225	0	250	

The smallest transportation cost is 13 in cell S1D2  
 The allocation to this cell is  $\min(50,225) = 50$ .  
 This exhausts the capacity of S1 and leaves  $225 - 50 = 175$  units with D2

	D1	D2	D3	Ddummy	Supply
S1	11( <b>200</b> )	13( <b>50</b> )	17	0	0
S2	16	18	14	0	300
S3	21	24	13( <b>275</b> )	0	125
Demand	0	175	0	250	

The smallest transportation cost is 18 in cell S2D2  
 The allocation to this cell is  $\min(300,175) = 175$ .  
 This satisfies the entire demand of D2 and leaves  $300 - 175 = 125$  units with S2

	D1	D2	D3	Ddummy	Supply
S1	11( <b>200</b> )	13( <b>50</b> )	17	0	0
S2	16	18( <b>175</b> )	14	0	125
S3	21	24	13( <b>275</b> )	0	125
Demand	0	0	0	250	

The smallest transportation cost is 0 in cell S2Ddummy  
 The allocation to this cell is  $\min(125,250) = 125$ .  
 This exhausts the capacity of S2 and leaves  $250 - 125 = 125$  units with Ddummy

	D1	D2	D3	Ddummy	Supply
S1	11( <b>200</b> )	13( <b>50</b> )	17	0	0
S2	16	18( <b>175</b> )	14	0( <b>125</b> )	0
S3	21	24	13( <b>275</b> )	0	125
Demand	0	0	0	125	

The smallest transportation cost is -1 in cell S2Ddummy  
 the allocation to this cell is  $\min(0,125) = 0$ .  
 This exhausts the capacity of S2 and leaves  $125 - 0 = 125$  units with Ddummy

Unit 11: Assignment and Transportation Problem

	D1	D2	D3	Ddummy	Supply
S1	11( <b>200</b> )	13( <b>50</b> )	17	0	0
S2	16	18( <b>175</b> )	14	0	0
S3	21	24	13( <b>275</b> )	0	125
Demand	0	0	0	125	

The smallest transportation cost is -1 in cell S2Ddummy

The allocation to this cell is  $\min(0,125) = 0$ .

This exhausts the capacity of S2 and leaves  $125 - 0 = 125$  units with Ddummy

	D1	D2	D3	Ddummy	Supply
S1	11( <b>200</b> )	13( <b>50</b> )	17	0	0
S2	16	18( <b>175</b> )	14	0	0
S3	21	24	13( <b>275</b> )	0	125
Demand	0	0	0	125	

The smallest transportation cost is -1 in cell S2Ddummy

The allocation to this cell is  $\min(0,125) = 0$ .

This exhausts the capacity of S2 and leaves  $125 - 0 = 125$  units with Ddummy

	D1	D2	D3	Ddummy	Supply
S1	11( <b>200</b> )	13( <b>50</b> )	17	0	0
S2	16	18( <b>175</b> )	14	0	0
S3	21	24	13( <b>275</b> )	0	125
Demand	0	0	0	125	

This is Initial feasible solution.

The minimum total transportation cost  $= 11 \times 200 + 13 \times 50 + 18 \times 175 + 13 \times 275 = 9575$

Here, the number of allocated cells = 4, which is two less than to  $m + n - 1 = 3 + 4 - 1 = 6$

$\therefore$  this solution is degenerate

## 11.6 IFS with VAM Method

An allocation is based on the opportunity (or penalty) cost that would have been incurred if the allocation in particular cells with the lowest unit transportation cost had been missed. As a result, allocations are made in a way that minimizes the penalty cost. This method yields an initial answer that is either closer to or the same as the optimal solution.

Steps are as followed:

**Step 1:** Calculate the penalties for each row (column) by taking the difference between the smallest and next smallest unit transportation cost in the same row (column). This difference indicates the penalty or extra cost that has to be paid if decision-maker fails to allocate to the cell with the minimum unit transportation cost.

**Step 2:** Select the row or column with the largest penalty and allocate as much as possible in the cell that has the least cost in the selected row or column and satisfies the rim conditions. If there is a tie

**Operations Management and Research**

in the values of penalties, it can be broken by selecting the cell where the maximum allocation can be made.

**Step 3:** Adjust the supply and demand and cross out the satisfied row or column. If a row and a column are satisfied simultaneously, only one of them is crossed out and the remaining row (column) is assigned a zero supply (demand). Any row or column with zero supply or demand should not be used in computing future penalties.

**Step 4:** Repeat Steps 1 to 3 until the available supply at various sources and demand at various destinations is satisfied.



**Example:** Find Solution using VAM method

	D1	D2	D3	Supply
S1	11	13	17	250
S2	16	18	14	300
S3	21	24	13	400
Demand	200	225	275	

**Solution:**

Here Total Demand = 700 is less than Total Supply = 950. So We add a dummy demand constraint with 0 unit cost and with allocation 250.

Now, the modified table is

	D1	D2	D3	Ddummy	Supply
S1	11	13	17	0	250
S2	16	18	14	0	300
S3	21	24	13	0	400
Demand	200	225	275	250	

	D1	D2	D3	Ddummy	Supply	Row Penalty
S1	11	13	17	0	250	11=11-0
S2	16	18	14	0	300	14=14-0
S3	21	24	13	0	400	13=13-0
Demand	200	225	275	250		
Column Penalty	5=16-11	5=18-13	1=14-13	0=0-0		

The maximum penalty, 14, occurs in row S2.

The minimum cij in this row is c24=0.



Unit 11: Assignment and Transportation Problem

The maximum allocation in this cell is  $\min(300,250) = 250$ .

It satisfy demand of Ddummy and adjust the supply of S2 from 300 to 50 ( $300 - 250=50$ ).

	D1	D2	D3	Ddummy	Supply	Row Penalty
S1	11	13	17	0	250	$2=13-11$
S2	16	18	14	0(250)	50	$2=16-14$
S3	21	24	13	0	400	$8=21-13$
Demand	200	225	275	0		
Column Penalty	$5=16-11$	$5=18-13$	$1=14-13$	--		

The maximum penalty, 8, occurs in row S3.

The minimum  $c_{ij}$  in this row is  $c_{33}=13$ .

The maximum allocation in this cell is  $\min(400,275) = 275$ .

It satisfy demand of D3 and adjust the supply of S3 from 400 to 125 ( $400 - 275=125$ ).

	D1	D2	D3	Ddummy	Supply	Row Penalty
S1	11	13	17	0	250	$2=13-11$
S2	16	18	14	0(250)	50	$2=18-16$
S3	21	24	13(275)	0	125	$3=24-21$
Demand	200	225	0	0		
Column Penalty	$5=16-11$	$5=18-13$	--	--		

The maximum penalty, 5, occurs in column D1.

The minimum  $c_{ij}$  in this column is  $c_{11}=11$ .

The maximum allocation in this cell is  $\min(250,200) = 200$ .

It satisfy demand of D1 and adjust the supply of S1 from 250 to 50 ( $250 - 200=50$ ).

	D1	D2	D3	Ddummy	Supply	Row Penalty
S1	11(200)	13	17	0	50	13
S2	16	18	14	0(250)	50	18
S3	21	24	13(275)	0	125	24
Demand	0	225	0	0		
Column Penalty	--	$5=18-13$	--	--		

*Operations Management and Research*

The maximum penalty, 24, occurs in row S3.

The minimum  $c_{ij}$  in this row is  $c_{32}=24$ .

The maximum allocation in this cell is  $\min(125,225) = 125$ .

It satisfy supply of S3 and adjust the demand of D2 from 225 to 100 ( $225 - 125=100$ ).

	D1	D2	D3	Ddummy	Supply	Row Penalty
S1	11( <b>200</b> )	13	17	0	50	13
S2	16	18	14	0( <b>250</b> )	50	18
S3	21	24( <b>125</b> )	13( <b>275</b> )	0	0	--
Demand	0	100	0	0		
Column Penalty	--	5=18-13	--	--		

The maximum penalty, 18, occurs in row S2.

The minimum  $c_{ij}$  in this row is  $c_{22}=18$ .

The maximum allocation in this cell is  $\min(50,100) = 50$ .

It satisfy supply of S2 and adjust the demand of D2 from 100 to 50 ( $100 - 50=50$ ).

	D1	D2	D3	Ddummy	Supply	Row Penalty
S1	11( <b>200</b> )	13	17	0	50	13
S2	16	18( <b>50</b> )	14	0( <b>250</b> )	0	--
S3	21	24( <b>125</b> )	13( <b>275</b> )	0	0	--
Demand	0	50	0	0		
Column Penalty	--	13	--	--		

The maximum penalty, 13, occurs in row S1.

The minimum  $c_{ij}$  in this row is  $c_{12}=13$ .

The maximum allocation in this cell is  $\min(50,50) = 50$ .

It satisfies supply of S1 and demand of D2.

Initial feasible solution is

	D1	D2	D3	Ddummy	Supply	Row Penalty
S1	11( <b>200</b> )	13( <b>50</b> )	17	0	250	11   2   2   13   13   13
S2	16	18( <b>50</b> )	14	0( <b>250</b> )	300	14   2   2   18   18   --
S3	21	24( <b>125</b> )	13( <b>275</b> )	0	400	13   8   3   24   --   --
Demand	200	225	275	250		

Unit 11: Assignment and Transportation Problem

	5	5	1	0		
Column	5	5	1	--		
Penalty	5	5	--	--		
	--	5	--	--		
	--	5	--	--		
	--	13	--	--		

The minimum total transportation cost =  $11 \times 200 + 13 \times 50 + 18 \times 50 + 0 \times 250 + 24 \times 125 + 13 \times 275 = 10325$

Here, the number of allocated cells = 6 is equal to  $m + n - 1 = 3 + 4 - 1 = 6$

$\therefore$  This solution is non-degenerate

### 11.7 Test for Optimality

After obtaining an initial solution, the following stage is to determine its optimal value in terms of solution feasibility and total minimum transit cost.

The test of optimality begins by calculating an opportunity cost for each unoccupied cell in the transportation table (which represents an underutilized route). To be included in the new set of transit routes, a vacant cell with the highest negative opportunity cost is chosen (allocations). This number represents the cost savings per unit that can be realized by allocating resources appropriately in the vacant cell. An arriving cell is another name for this type of cell (or variable). The occupied cell (basic variable) is the outgoing cell (or variable) from the current solution, where allocation will become zero as allocation is performed in the vacant cell with the highest negative opportunity cost. The total transportation cost is reduced as a result of this transaction. The method is repeated until no negative opportunity cost remains. That is to say, the current solution is the best option.

### 11.8 The Modified-distribution (MODI) method

The Modified-distribution (MODI) method (also known as the u-v method or multiplier method) is used to compute the opportunity cost associated with each unoccupied cell before optimizing the present solution.

In MODI method, dual variables are used. The dual variables  $u_i$  and  $v_j$  represent the shadow price (value of the commodity) for the supply centers and demand centers, respectively. Steps involved in MODI method is as followed:

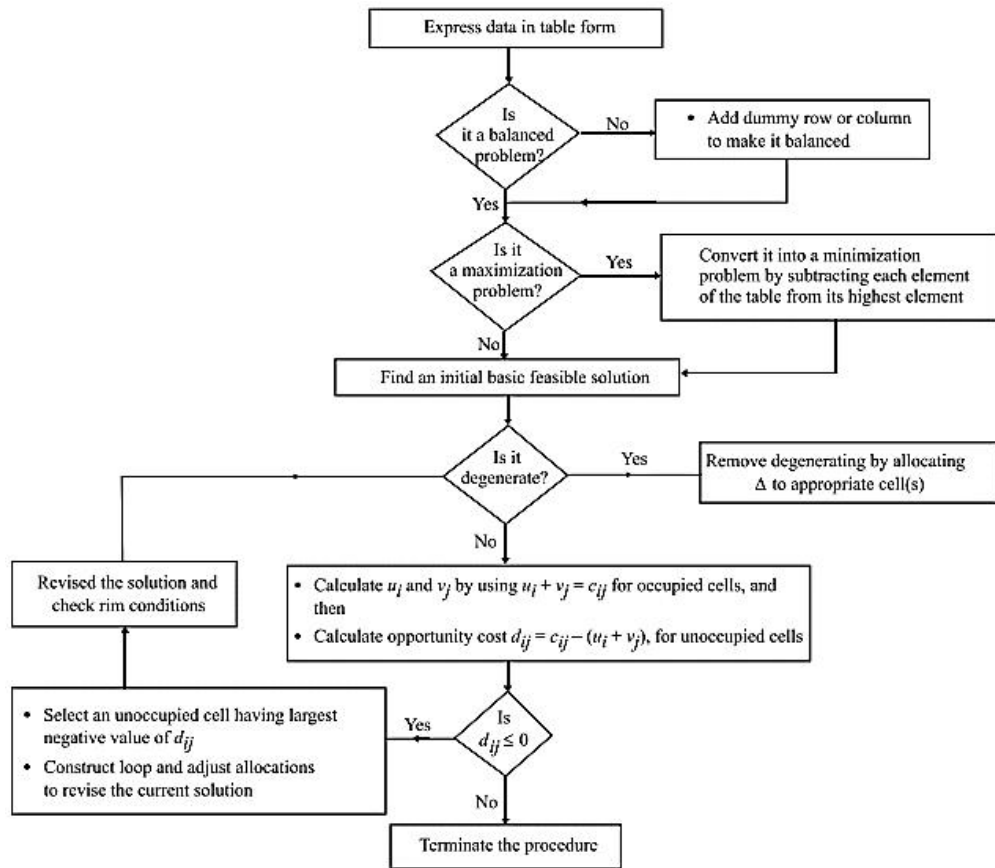

Source: Operation Research by J.K.Sharma



Example: Test the following IFS (obtained through VAM) for optimality by MODI method:

	D1	D2	D3	Ddummy	Supply
S1	11(200)	13(50)	17	0	250
S2	16	18(50)	14	0(250)	300
S3	21	24(125)	13(275)	0	400
Demand	200	225	275	250	

Solution:

Iteration-1 of optimality test

1. Find  $u_i$  and  $v_j$  for all occupied cells  $(i,j)$ , where  $c_{ij}=u_i+v_j$

Substituting,  $v_2=0$ , we get

$$c_{12}=u_1+v_2 \Rightarrow u_1=c_{12}-v_2 \Rightarrow u_1=13-0 \Rightarrow u_1=13$$

$$c_{11}=u_1+v_1 \Rightarrow v_1=c_{11}-u_1 \Rightarrow v_1=11-13 \Rightarrow v_1=-2$$

$$c_{22}=u_2+v_2 \Rightarrow u_2=c_{22}-v_2 \Rightarrow u_2=18-0 \Rightarrow u_2=18$$

$$c_{24}=u_2+v_4 \Rightarrow v_4=c_{24}-u_2 \Rightarrow v_4=0-18 \Rightarrow v_4=-18$$

$$c_{32}=u_3+v_2 \Rightarrow u_3=c_{32}-v_2 \Rightarrow u_3=24-0 \Rightarrow u_3=24$$

$$c_{33}=u_3+v_3 \Rightarrow v_3=c_{33}-u_3 \Rightarrow v_3=13-24 \Rightarrow v_3=-11$$

## Unit 11: Assignment and Transportation Problem

	D1	D2	D3	Ddummy	Supply	ui
S1	11 <b>(200)</b>	13 <b>(50)</b>	17	0	250	$u_1=13$
S2	16	18 <b>(50)</b>	14	0 <b>(250)</b>	300	$u_2=18$
S3	21	24 <b>(125)</b>	13 <b>(275)</b>	0	400	$u_3=24$
Demand	200	225	275	250		
vj	$v_1=-2$	$v_2=0$	$v_3=-11$	$v_4=-18$		

2. Find  $d_{ij}$  for all unoccupied cells  $(i,j)$ , where  $d_{ij}=c_{ij}-(u_i+v_j)$

$$d_{13}=c_{13}-(u_1+v_3)=17-(13-11)=15$$

$$d_{14}=c_{14}-(u_1+v_4)=0-(13-18)=5$$

$$d_{21}=c_{21}-(u_2+v_1)=16-(18-2)=0$$

$$d_{23}=c_{23}-(u_2+v_3)=14-(18-11)=7$$

$$d_{31}=c_{31}-(u_3+v_1)=21-(24-2)=-1$$

$$d_{34}=c_{34}-(u_3+v_4)=0-(24-18)=-6$$

	D1	D2	D3	Ddummy	Supply	ui
S1	11 <b>(200)</b>	13 <b>(50)</b>	17 [15]	0 [5]	250	$u_1=13$
S2	16 [0]	18 <b>(50)</b>	14 [7]	0 <b>(250)</b>	300	$u_2=18$
S3	21 [-1]	24 <b>(125)</b>	13 <b>(275)</b>	0 [-6]	400	$u_3=24$
Demand	200	225	275	250		
vj	$v_1=-2$	$v_2=0$	$v_3=-11$	$v_4=-18$		

3. Now choose the minimum negative value from all  $d_{ij}$  (opportunity cost) =  $d_{34} = [-6]$  and draw a closed path from S3Ddummy.

Closed path is S3Ddummy → S3D2 → S2D2 → S2Ddummy

Closed path and plus/minus sign allocation...

	D1	D2	D3	Ddummy	Supply	ui
S1	11 <b>(200)</b>	13 <b>(50)</b>	17 [15]	0 [5]	250	$u_1=13$
S2	16 [0]	18 <b>(50)(+)</b>	14 [7]	0 <b>(250)(-)</b>	300	$u_2=18$
S3	21 [-1]	24 <b>(125)(-)</b>	13 <b>(275)</b>	0 [-6] <b>(+)</b>	400	$u_3=24$
Demand	200	225	275	250		
vj	$v_1=-2$	$v_2=0$	$v_3=-11$	$v_4=-18$		

4. Minimum allocated value among all negative position (-) on closed path = 125  
Subtract 125 from all (-) and Add it to all (+)

	D1	D2	D3	Ddummy	Supply
S1	11 (200)	13 (50)	17	0	250
S2	16	18 (175)	14	0 (125)	300
S3	21	24	13 (275)	0 (125)	400
Demand	200	225	275	250	

5. Repeat the step 1 to 4, until an optimal solution is obtained.

### Iteration-2 of optimality test

1. Find  $u_i$  and  $v_j$  for all occupied cells  $(i,j)$ , where  $c_{ij}=u_i+v_j$

Substituting,  $u_1=0$ , we get

$$c_{11}=u_1+v_1 \Rightarrow v_1=c_{11}-u_1 \Rightarrow v_1=11-0 \Rightarrow v_1=11$$

$$c_{12}=u_1+v_2 \Rightarrow v_2=c_{12}-u_1 \Rightarrow v_2=13-0 \Rightarrow v_2=13$$

$$c_{22}=u_2+v_2 \Rightarrow u_2=c_{22}-v_2 \Rightarrow u_2=18-13 \Rightarrow u_2=5$$

$$c_{24}=u_2+v_4 \Rightarrow v_4=c_{24}-u_2 \Rightarrow v_4=0-5 \Rightarrow v_4=-5$$

$$c_{34}=u_3+v_4 \Rightarrow u_3=c_{34}-v_4 \Rightarrow u_3=0+5 \Rightarrow u_3=5$$

$$c_{33}=u_3+v_3 \Rightarrow v_3=c_{33}-u_3 \Rightarrow v_3=13-5 \Rightarrow v_3=8$$

	D1	D2	D3	Ddummy	Supply	$u_i$
S1	11 (200)	13 (50)	17	0	250	$u_1=0$
S2	16	18 (175)	14	0 (125)	300	$u_2=5$
S3	21	24	13 (275)	0 (125)	400	$u_3=5$
Demand	200	225	275	250		
$v_j$	$v_1=11$	$v_2=13$	$v_3=8$	$v_4=-5$		

2. Find  $d_{ij}$  for all unoccupied cells  $(i,j)$ , where  $d_{ij}=c_{ij}-(u_i+v_j)$

$$d_{13}=c_{13}-(u_1+v_3)=17-(0+8)=9$$

$$d_{14}=c_{14}-(u_1+v_4)=0-(0-5)=5$$

$$d_{21}=c_{21}-(u_2+v_1)=16-(5+11)=0$$

$$d_{23}=c_{23}-(u_2+v_3)=14-(5+8)=1$$

$$d_{31}=c_{31}-(u_3+v_1)=21-(5+11)=5$$

$$d_{32}=c_{32}-(u_3+v_2)=24-(5+13)=6$$

	D1	D2	D3	Ddummy	Supply	$u_i$
S1	11 (200)	13 (50)	17 [9]	0 [5]	250	$u_1=0$

Unit 11: Assignment and Transportation Problem

S2	16 [0]	18 (175)	14 [1]	0 (125)	300	$u_2 = 5$
S3	21 [5]	24 [6]	13 (275)	0 (125)	400	$u_3 = 5$
Demand	200	225	275	250		
$v_j$	$v_1 = 11$	$v_2 = 13$	$v_3 = 8$	$v_4 = -5$		

Since all  $d_{ij} \geq 0$ .

So final optimal solution is arrived.

	D1	D2	D3	Ddummy	Supply
S1	11 (200)	13 (50)	17	0	250
S2	16	18 (175)	14	0 (125)	300
S3	21	24	13 (275)	0 (125)	400
Demand	200	225	275	250	

The minimum total transportation cost =  $11 \times 200 + 13 \times 50 + 18 \times 175 + 0 \times 125 + 13 \times 275 + 0 \times 125 = 9575$

Notice alternate solution is available with unoccupied cell S2D1:  $d_{21} = [0]$ , but with the same optimal value.

## 11.9 Assignment Problem

A fundamental combinatorial optimization problem is the assignment problem. The problem can be stated in its most general form as follows: There are several agents and tasks in this problem instance. Any agent can be assigned to any task, which comes at a cost that varies depending on the agent-task assignment.

The assignment problem is a type of LPP that involves assigning personnel to machines, clerks to various checkouts, salespeople to various sales areas, service crews to various districts, and so on. Because people have diverse capacities for completing different activities, assignment is a challenge. As a result, the prices of performing those jobs by different persons vary. Obviously, if everyone could complete a task in the same amount of time or for the same price, it wouldn't matter who was assigned the task. In an assignment problem, the question is how to make the assignments in such a way that the total cost is reduced.

The problem is known as balanced assignment if the number of agents and tasks are equal. Otherwise, it's referred to as an unbalanced assignment. The problem is called linear assignment when the total cost of the assignment for all tasks equals the sum of the costs for each agent (or the sum of the costs for each job (which is the same thing in this case).

## 11.10 Hungarian Method

Hungarian method is used to solve assignment problem. Following steps are taken for the same:

1. Develop the cost matrix from the given problem
2. Find the opportunity cost matrix

3. Make assignments in the opportunity cost matrix
4. Optimality criterion
5. Revise the opportunity cost matrix
6. Develop the new revised opportunity cost matrix
7. Repeat steps

Process is explained in the flowchart below:

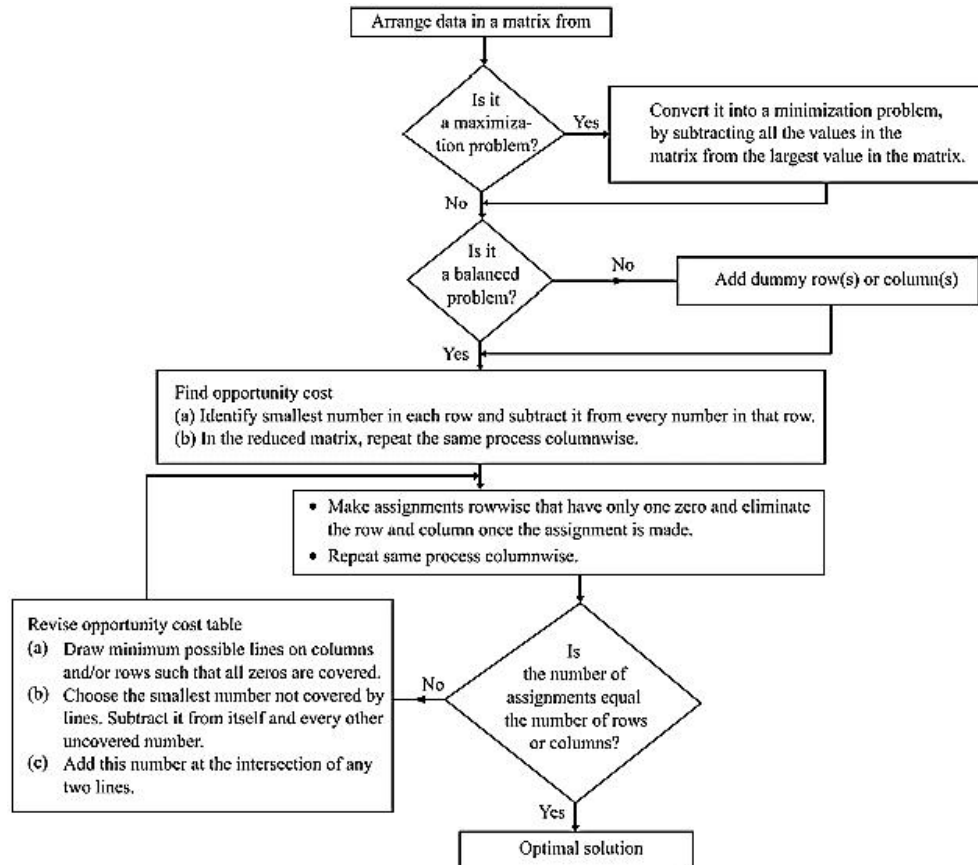

Source: Operation Research by J.K.Sharma



Example:

**Find Solution of Assignment problem using Hungarian method-1 (MIN case)**

Work \ Job	1	2	3	4	5
A	10	5	13	15	16
B	3	9	18	13	6
C	10	7	2	2	2
D	7	11	9	7	12

**Solution:**

The number of rows = 4 and columns = 5

Here given problem is unbalanced and add 1 new row to convert it into a balance.



Unit 11: Assignment and Transportation Problem

	1	2	3	4	5	
A	10	5	13	15	16	
B	3	9	18	13	6	
C	10	7	2	2	2	
D	7	11	9	7	12	
W5	0	0	0	0	0	

**Step-1: Find out the each row minimum element and subtract it from that row**

	1	2	3	4	5	
A	5	0	8	10	11	(-5)
B	0	6	15	10	3	(-3)
C	8	5	0	0	0	(-2)
D	0	4	2	0	5	(-7)
W5	0	0	0	0	0	(-0)

**Step-2: Find out the each column minimum element and subtract it from that column.**

	1	2	3	4	5	
A	5	0	8	10	11	
B	0	6	15	10	3	
C	8	5	0	0	0	
D	0	4	2	0	5	
W5	0	0	0	0	0	
	(-0)	(-0)	(-0)	(-0)	(-0)	

**Iteration-1 of steps 3 to 6**

Step-3: Make assignment in the opportunity cost table

- (1) Rowwise cell (A,2) is assigned, so columnwise cell (W5,2) crossed off.
- (2) Rowwise cell (B,1) is assigned, so columnwise cell (D,1),(W5,1) crossed off.
- (3) Rowwise cell (D,4) is assigned, so columnwise cell (C,4),(W5,4) crossed off.
- (4) Rowwise cell (C,3) is assigned, so columnwise cell (W5,3) crossed off., sorowwise cell (C,5) crossed off.
- (5) Rowwise cell (W5,5) is assigned

Rowwise&columnwise assignment shown in table

	1	2	3	4	5	

A	5	[0]	8	10	11	
B	[0]	6	15	10	3	
C	8	5	[0]	0	0	
D	0	4	2	[0]	5	
W5	0	0	0	0	[0]	

Step-4: Number of assignments = 5, number of rows = 5

Which is equal, so solution is optimal?

Optimal assignments are

	1	2	3	4	5	
A	5	[0]	8	10	11	
B	[0]	6	15	10	3	
C	8	5	[0]	0	0	
D	0	4	2	[0]	5	
W5	0	0	0	0	[0]	

Optimal solution is

Work	Job	Cost
A	2	5
B	1	3
C	3	2
D	4	7
W5	5	0
	Total	17

#### Alternate Solution-2

opportunity cost table

	1	2	3	4	5	
A	5	0	8	10	11	
B	0	6	15	10	3	
C	8	5	0	0	0	
D	0	4	2	0	5	

Unit 11: Assignment and Transportation Problem

W5	0	0	0	0	0	

Step-3: Make assignment in the opportunity cost table

- (1) Rowwise cell (A,2) is assigned, so columnwise cell (W5,2) crossed off.
- (2) Rowwise cell (B,1) is assigned, so columnwise cell (D,1),(W5,1) crossed off.
- (3) Rowwise cell (D,4) is assigned, so columnwise cell (C,4),(W5,4) crossed off.
- (4) Rowwise cell (C,5) is assigned, so columnwise cell (W5,5) crossed off., so rowwise cell (C,3) crossed off.
- (5) Rowwise cell (W5,3) is assigned

Rowwise&columnwise assignment shown in table

	1	2	3	4	5	
A	5	[0]	8	10	11	
B	[0]	6	15	10	3	
C	8	5	∅	∅	[0]	
D	∅	4	2	[0]	5	
W5	∅	∅	[0]	∅	∅	

Step-4: Number of assignments = 5, number of rows = 5

Which is equal, so solution is optimal

Optimal assignments are

	1	2	3	4	5	
A	5	[0]	8	10	11	
B	[0]	6	15	10	3	
C	8	5	∅	∅	[0]	
D	∅	4	2	[0]	5	
W5	∅	∅	[0]	∅	∅	

Optimal solution is

Wor k	Job	Cos t
A	2	5
B	1	3

C	5	2
D	4	7
W5	3	0
	Total	17

### Summary

- The transportation problem's structure entails many shipping routes from multiple supply locations to multiple demand centres. The goal is to determine the number of units of an item (commodity or product) that should be shipped from an origin to a destination in order to satisfy the required quantity of goods or services at each destination centre.
- A balanced transportation problem occurs when total supply equals total demand; otherwise, an unbalanced transportation problem occurs. When the need arises, a dummy supply centre (row) or a dummy demand centre (column) can be added to balance the unbalanced transportation situation.
- The solution is considered to be degenerate if the number of positive allocations (values of choice variables) at any step of the viable solution is fewer than the needed number (rows + columns - 1), i.e. number of independent constraint equations.
- Cells in the transportation table with a positive allocation, i.e.,  $x_{ij} > 0$ , are referred to as occupied cells, whereas non-occupied (or empty) cells are referred to as non-occupied (or empty) cells.
- The North-West Corner Method, the Least Cost Method, and Vogel's Approximation (or Penalty) Method are three ways for obtaining an initial basic feasible solution.
- The Modified-distribution (MODI) method (also called u-v method or method of multipliers) is used to calculate opportunity cost associated with each unoccupied cell and then improving the current solution leading to an optimal solution
- An assignment problem is a particular case of a transportation problem where the resources (say facilities) are assignees and the destinations are activities
- The problem of assignment arises because the resources that are available such as men, machines, etc., have varying degree of efficiency for performing different activities. Therefore, the cost, profit or time of performing different activities is also different.

### Keywords

**Assignment Problem:** An assignment problem is a particular case of transportation problem where the objective is to assign a number of resources to an equal number of activities so as to minimize total cost or maximize total profit of allocation

**Balanced Transportation Problem:** When total demand equals total supply, the transportation problem is said to be balanced

**Degenerated Transportation Problem:** In a transportation problem with  $m$  origins and  $n$  destinations, if a basic feasible solution has less than  $m + n - 1$  allocation (occupied cells), the problem is said to be a degenerate transportation problem

**Dual Variable:** A variable which measures the comparative advantage of additional unit of supply or shadow price (or value) of available supply at centre.

**Transportation Problem:** Transportation problem is a special kind of Linear Programming Problem (LPP) in which goods are transported from a set of sources to a set of destinations subject to the supply and demand of the sources and destination respectively such that the total cost of transportation is minimized.

### **Self Assessment**

1. Assignment problem is solved through:
  - A. Reduced matrix method
  - B. MODI method
  - C. Hungarian method
  - D. None of the above
  
2. An activity is assigned to a resource through a square with zero opportunity cost in an assignment problem. Why?
  - A. Minimize total cost of assignment
  - B. Reduce the cost of assignment to zero
  - C. Reduce the cost of that particular assignment to zero
  - D. All of the above
  
3. An assignment problem is considered as a special case of a transportation problem as:
  - A. The number of rows equals columns
  - B. All  $x_{ij} = 0$  or 1
  - C. All rim conditions are 1
  - D. All of the above
4. In an assignment problem, number of assignments should be:
  - A. Rows or columns
  - B. Rows and columns
  - C. Rows + columns - 1
  - D. None of the above
  
5. An assignment problem can also be solved by
  - A. Simplex method
  - B. Transportation method
  - C. Both (a) and (b)
  - D. None of the above
  
6. What is true for an Assignment problem
  - A. Requires that only one activity be assigned to each resource
  - B. A special case of transportation problem
  - C. Can be used to maximize resources
  - D. All of the above
  
7. While solving transportation problem for initial feasible solution, what should be considered?
  - A. The solution be optimal

- B. The rim conditions are satisfied
  - C. The solution not be degenerate
  - D. All of the above
8. Dummy is added in transportation problem to:
- A. Satisfy rim conditions
  - B. Prevent solution from becoming degenerate
  - C. Ensure that total cost does not exceed a limit
  - D. None of the above
9. North-west-corner method has a shortcoming over other methods that:
- A. It is complicated to use
  - B. It does not take into account cost of transportation
  - C. It leads to a degenerate initial solution
  - D. All of the above
10. Transportation problem (with  $m$ -rows and  $n$ -columns) solution is considered feasible when number of positive allocations is:
- A.  $m + n$
  - B.  $m \times n$
  - C.  $m + n - 1$
  - D.  $m + n + 1$
11. VAM, a method to find initial feasible solution for transportation problem, stands for:
- A. Vogel's approximation method
  - B. Value addition method
  - C. Value approximation method
  - D. None of the above
12. Which method(s) is/are used to verify the optimality of the current solution of the transportation problem,
- A. Least cost method
  - B. Vogel's approximation method
  - C. Modified distribution method
  - D. All of the above
13. Which of the following method is expected to give solution closer to optimum solution?
- A. NWC method
  - B. LCM method
  - C. VAM method
  - D. All of the above
14. The Hungarian method for solving an assignment problem can also be used to solve
- A. A transportation problem

Unit 11: Assignment and Transportation Problem

- B. A travelling salesman problem  
 C. Both (a) and (b)  
 D. Only (b)
15. An optimal solution of an assignment problem can be obtained only if  
 A. Each row and column has only one zero element  
 B. Each row and column has at least one zero element  
 C. The data are arrangement in a square matrix  
 D. None of the above

**Answers for Self Assessment**

1. C      2. A      3. D      4. A      5. C  
 6. D      7. B      8. A      9. B      10. C  
 11. A      12. C      13. C      14. B      15. D

**Review Questions**

1. Explain a real scenario where solution can be achieved using Assignment method.
2. Explain a real life application of Transportation model.
3. A dairy company has three freezers and five ice cream machines. The transportation costs (rupees per unit) for shipping cold content from freezers to machines are given in the following table:

	M1	M2	M3	M4	M5	Supply	
F1		40	20	30	20	60	1800
F2		50	40	50	20	10	1200
F3		60	50	40	70	70	1400
Demand		400	400	600	800	800	

What is the optimal shipping schedule?

4. Refer the following table:

		To			
		I	II	III	Supply
From	A	5	1	7	10
	B	6	4	6	80
	C	3	2	5	15
Demand		75	20	50	

Demand of cars to three markets (I, II, & III) is fulfilled from three locations (A, B & C). Cost of transportation for each route (in '000) is reflecting in the table. Find most optimum schedule.

5. Refer the following distribution and find Initial feasible solution using North west corner method. Solve it further with MODI method and comment on results.

	<i>I</i>	<i>II</i>	<i>III</i>	<i>IV</i>
<i>A</i>	20	21	16	18
<i>B</i>	17	28	14	16
<i>C</i>	29	23	19	20

6. Refer the following distribution and find Initial feasible solution using Least cost method. Solve it further with MODI method and comment on results.

	<i>I</i>	<i>II</i>	<i>III</i>	<i>IV</i>
<i>A</i>	20	21	16	18
<i>B</i>	17	28	14	16
<i>C</i>	29	23	19	20

7. Refer the following distribution and find Initial feasible solution using VAM method. Solve it further with MODI method and comment on results.

	<i>I</i>	<i>II</i>	<i>III</i>	<i>IV</i>
<i>A</i>	20	21	16	18
<i>B</i>	17	28	14	16
<i>C</i>	29	23	19	20

8. Find Solution of Assignment problem using Hungarian method-1 (MIN case)

Work <sup>Job</sup>	1	2	3	4
<b>A</b>	85	75	65	125
<b>B</b>	90	78	66	132
<b>C</b>	75	66	57	114
<b>D</b>	80	72	60	120
<b>E</b>	76	64	56	112

9. Find Solution of Assignment problem using Hungarian method-1 (MAX case)

Work <sup>Job</sup>	1	2	3	4
<b>A</b>	85	75	65	125
<b>B</b>	90	78	66	132
<b>C</b>	75	66	57	114
<b>D</b>	80	72	60	120
<b>E</b>	76	64	56	112



**Further Readings**

Operations Research, By Sivarethinamohan, McGraw-Hill Education (India) Pvt Limited  
Quantitative Techniques, Theory and Problems, By P. C. Tulsian, Pearson Education

**Web Links**

<https://www.hungarianalgorithm.com/examplehungarianalgorithm.php>

<https://www.mbaknol.com/management-science/transportation-and-assignment-models-in-operations-research/>

**Unit 12: Project Management and Queuing Theory****CONTENTS**

Objectives

Introduction

- 12.1 Project Management
- 12.2 PERT & CPM Difference
- 12.3 Network Components
- 12.4 AOA and AON Representation
- 12.5 Errors and Dummies in PERT/CPM Network
- 12.6 CPM Process
- 12.7 Floats in CPM
- 12.8 PERT Process
- 12.9 Queuing Theory
- 12.10 Kendall Notations
- 12.11 M/M/1 : Infinite/FCFS Model

Keywords

Self Assessment

Answers for Self Assessment

Review Questions

Further Readings

**Objectives**

After studying this unit, you will be able to:

- Understand difference between PERT and CPM
- Identify critical activities
- Schedule projects efficiently
- Optimize queue length for better service levels

**Introduction**

Project management is the process of managing a team's efforts to meet all project objectives while staying within budget restrictions. Typically, this data is described in project documentation, which is prepared at the start of the development process. Scope, time, and budget are the three main restraints.

On a very basic level, project management includes the planning, initiation, execution, monitoring, and closing of project. Many different types of project management methodologies and techniques exist, including traditional, waterfall, agile, and lean. Project management is used across industries and is an important part of the success of construction, engineering, and IT companies.

A. K. Erlang is credited with the invention of queuing theory. He began investigating the impact of variable service demand on the use of automatic dial technology in 1905. However, the waiting line model may now be used to explain a wide range of problem situations.

A queue, often known as a waiting line, is a relatively familiar sight in everyday life. There's a line for the bus, a line for rations, a line for a movie ticket, and so on. Standing in line wastes a lot of

time that could be spent doing something else. Queues can also be seen on the shop floor, where in-process goods wait for the next operation or inspection, or to be transported to a different location. Such delays in the manufacturing lines, of course, lengthen production cycles, raise product costs, and may disrupt the entire system, making it impossible to achieve given delivery dates, causing annoyance to powerful customers.

If waiting lines cannot be totally eliminated (economically), they can be minimized by increasing the number of service stations or altering the service timings at one or more of them. Queue forming issues are solved using waiting line theory or queuing theory.

## 12.1 Project Management

Following definitions appropriately define project management:

- The techniques of operations research used for planning, scheduling and controlling large and complex projects are often referred to as *network analysis, network planning or network planning and scheduling techniques*.
- Project management is the discipline of using established principles, procedures and policies to successfully guide a project from conception through completion.

## 12.2 PERT & CPM Difference

PERT and CPM are two project management techniques used in different scenarios. PERT is the technique used to manage uncertain (i.e., time is not known) activities of any project. CPM is used to manage only certain (i.e., time is known) activities of any project. Other difference in these two methods is as followed:

PERT	CPM
Element of uncertainty in the estimation of duration.	One estimate of completion time of each activity.
Three estimates are used to form a weighted average of the expected completion time of each activity.	Duration of each activity was known with certainty.
Helps in identifying critical areas in a project so that necessary adjustments can be made.	Used for completing of projects that involve activities of repetitive nature.

## 12.3 Network Components

Network diagram is represented using following components:

**Nodes:** Nodes are breakpoints representing end of an activity and starting of another one.

## 12.4 AOA and AON Representation

These are two different ways of representing activities, involved in a project.

**Activity on Arrow (AOA):** Nodes are connected by arrows, each representing an activity. Nodes have different incremental numbers representing flow of the project.

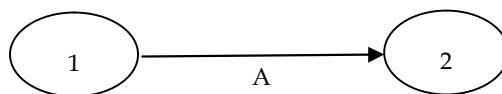

If an activity is presided by multiple activities, multiple activities may be converging on a single node. If multiple activities have a common preceding activity, multiple arrows burst out of a single node.

Unit 12: Project Management and Queuing Theory

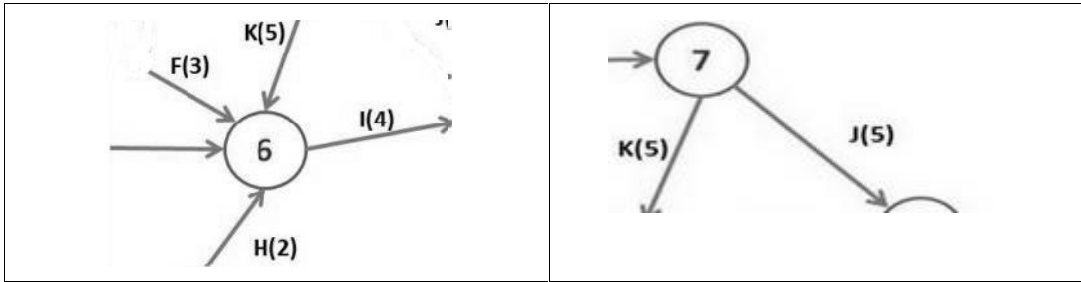

Activity on Node (AON): Arrows connect nodes, each representing an activity. Precedence condition can be easily represented without using dummy activities.

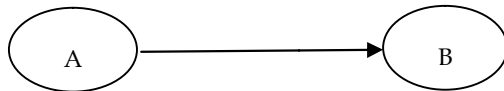

Both AOA and AON can be used for representation. We will be using AOA further in this text.

12.5 Errors and Dummies in PERT/CPM Network

Certain representations are not used to represent project flow. These errors are:

	<p><b>Looping:</b> This is considered as an error because every project is expected to start and end within a time period. Looping results in never ending project representation</p>
	<p><b>Dangling:</b> If one activity is dangling, its completion or non-completion doesn't affect project duration. This simply means that this activity is not a part of the project. Thus, such activities should either be removed or should be connected to end node.</p>
	<p><b>Parallel Activities:</b> Parallel activities should not be represented with same starting and ending node. Alternate representations can be picked based on the precedence conditions:</p>

12.6 CPM Process

Critical path method involves following steps:

- Precedence diagram
- Forward Pass (Early Start & Early Finish)
- Backward Pass (Late Start & Late Finish)
- Critical Path (Connected activities with Zero Slack)

Example:

Activity	Precedence Activity	Duration
A	-	14

B	A	4
C	B	2
D	C	1
E	A	2
F	E	3
G	E	2
H	E	4
I	H,L	3
J	K	12
K	D,F,G	4
L	J	2

**Step 1: Precedence diagram:**

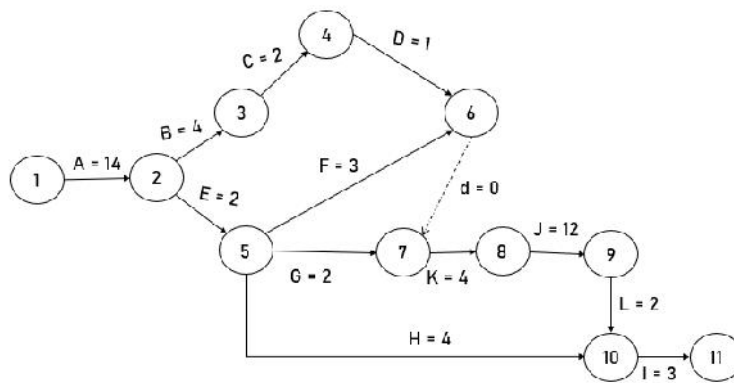

Here, d=0 represents dummy activity with duration = 0. Activities are represented on arrows.

**Step - 2: Forward Pass:**

Early start is a time by which any activity can start. Early finish is completion time of the activity and is calculated as:

$$\text{Early finish} = \text{Early start} + \text{Activity duration.}$$

Early start of following activity is calculated as:

$$\text{Early start (i+1)} = \text{Early finish (i)}$$

In case of multiple precedence activities, early start of following activity is calculated as:

$$\text{Early start (i+1)} = \text{Max. (Early finish of precedent activities)}$$

Early start and early finish calculations for forward pass is as followed:

- E1=0
- E2=E1+t1,2 [t1,2=A=14]=0+14=14
- E3=E2+t2,3 [t2,3=B=4]=14+4=18
- E4=E3+t3,4 [t3,4=C=2]=18+2=20
- E5=E2+t2,5 [t2,5=E=2]=14+2=16
- E6=Max{Ei+ti,6}[i=4,5,6]=Max{E4+t4,6;E5+t5,6}=Max{20+1;16+3}=Max{21;19}=21
- E7=Max{Ei+ti,7}[i=5,6,7]=Max{E5+t5,7;E6+t6,7}=Max{16+2;21+0}=Max{18;21}=21
- E8=E7+t7,8 [t7,8=K=4]=21+4=25
- E9=E8+t8,9 [t8,9=J=12]=25+12=37
- E10=Max{Ei+ti,10}[i=5,9,10]=Max{E5+t5,10;E9+t9,10}=Max{16+4;37+2}=Max{20;39}=39
- E11=E10+t10,11 [t10,11=I=3]=39+3=42

**Step - 3: Backward Pass**

Late finish is maximum possible completion time of the activity. Late start is a time by which any activity should start and is calculated as:

$$\text{Late finish} - \text{Activity duration} = \text{Late start}$$

## Unit 12: Project Management and Queuing Theory

Late finish of following activity is calculated as:

$$\text{Late finish (i)} = \text{Late start (i+1)}$$

In case of multiple precedence activities, early start of following activity is calculated as:

$$\text{Late finish (i)} = \text{Min. (Late start of following activities)}$$

Late start and late finish calculations for forward pass is as followed:

$$L_{11} = E_{11} = 42$$

$$L_{10} = L_{11} - t_{10,11} [t_{10,11} = I = 3] = 42 - 3 = 39$$

$$L_9 = L_{10} - t_{9,10} [t_{9,10} = L = 2] = 39 - 2 = 37$$

$$L_8 = L_9 - t_{8,9} [t_{8,9} = J = 12] = 37 - 12 = 25$$

$$L_7 = L_8 - t_{7,8} [t_{7,8} = K = 4] = 25 - 4 = 21$$

$$L_6 = L_7 - t_{6,7} [t_{6,7} = d = 0] = 21 - 0 = 21$$

$$L_5 = \text{Min}\{L_j - t_{5,j}\} [j=10,7,6] = \text{Min}\{L_{10} - t_{5,10}; L_7 - t_{5,7}; L_6 - t_{5,6}\} = \text{Min}\{39 - 4; 21 - 2; 21 - 3\} = \text{Min}\{35; 19; 18\} = 18$$

$$L_4 = L_6 - t_{4,6} [t_{4,6} = D = 1] = 21 - 1 = 20$$

$$L_3 = L_4 - t_{3,4} [t_{3,4} = C = 2] = 20 - 2 = 18$$

$$L_2 = \text{Min}\{L_j - t_{2,j}\} [j=5,3] = \text{Min}\{L_5 - t_{2,5}; L_3 - t_{2,3}\} = \text{Min}\{18 - 2; 18 - 4\} = \text{Min}\{16; 14\} = 14$$

$$L_1 = L_2 - t_{1,2} [t_{1,2} = A = 14] = 14 - 14 = 0$$

### Step-4: Critical Path

Critical path is identified by connecting starting and end node with set of activities where early start = late start (or early finish = late finish).

The critical path of the project is: 1-2-3-4-6-7-8-9-10-11 and critical activities are A,B,C,D,d,K,J,L,I  
The total project time is 42

## 12.7 Floats in CPM

It is the amount of activity time that can increase or delayed without delaying project completion time. This float is calculated as the difference between the latest finish time and the earliest finish time for the activity. Three types of floats are:

<b>Total float (TF<sub>ij</sub>)</b> = $(L_j - E_i) - t_{ij}$ = $LS_{ij} - ES_{ij} = LF_{ij} - EF_{ij}$	This is the length of time by which an activity can be delayed until all preceding activities are completed at their earliest possible time and all successor activities can be delayed until their latest permissible time.
<b>Free float (FF<sub>ij</sub>)</b> = $(E_j - E_i) - t_{ij} = \text{Min}\{ES_{ij}, \text{for all immediate successors of activity (i, j)}\} - EF_{ij}$	This is the length of time by which the completion time of any non-critical activity can be delayed without causing any delay in its immediate successor activities.
<b>Independent float (IF<sub>ij</sub>)</b> = $(E_j - L_i) - t_{ij} = \{ES_{ij} - LS_{ij}\} - t_{ij}$	This is the length of time by which completion time of any non-critical activity (i, j) can be delayed without causing any delay in its predecessor or the successor activities.

Floats in the above example can be calculated as:

Activity (i,j) (1)	Duration (t <sub>ij</sub> ) (2)	Earliest time Start (E <sub>i</sub> ) (E <sub>j</sub> ) (L <sub>i</sub> ) (3) (4) (5)			Latest time Finish (L <sub>j</sub> ) (6)	Earliest time Finish (E <sub>i</sub> - t <sub>ij</sub> ) (7) = (3) + (2)	Latest time Start (L <sub>j</sub> - t <sub>ij</sub> ) (8) = (6) - (2)	Total Float (L <sub>j</sub> - t <sub>ij</sub> ) - E <sub>i</sub> (9) = (8) - (3)	Free Float (E <sub>j</sub> - E <sub>i</sub> ) - t <sub>ij</sub> (10) = ((4) - (3)) - (2)	Independent Float (E <sub>j</sub> - L <sub>i</sub> ) - t <sub>ij</sub> (11) = ((4) - (5)) - (2)
2-5	2	14	16	14	18	15	15	2	0	0
5-6	3	16	21	18	21	19	18	2	2	0
5-7	2	16	21	18	21	18	19	3	3	1
5-10	4	16	39	18	39	20	35	19	19	17

## 12.8 PERT Process

The US Navy's Special Projects Office first generated PERT charts in the 1950s to assist the Polaris nuclear submarine project. PERT charts use nodes, which are spheres or rectangles that represent project events or milestones. Vectors, or lines, connect these nodes, which represent various jobs.

### Operations Management and Research

Managers can use a PERT chart to estimate the amount of time and resources needed to complete a project.

A PERT chart is a visual representation of a sequence of events that must occur during the life of a project. The flow and sequence of events required for project completion are indicated by the direction of the arrows. Dummy activities—items that are located on a different PERT path—are represented by dotted activity lines. Within each vector, numbers and time allotments are assigned and shown.

These graphs have their own set of definitions and terminologies, the most essential of which predicts how long a project will take to complete. The smallest period is referred to as "optimistic time." The logically longest time frame is "pessimistic time." The "most likely time" is a conservative estimate of the best-case scenario, whereas the "expected time" takes into account problems and roadblocks.

Program Evaluation Review Technique PERT involves following steps:

- Precedence diagram
- Estimated time and activity standard deviation calculations
- Forward Pass (Early Start & Early Finish) using estimated time
- Backward Pass (Late Start & Late Finish) using estimated time
- Critical Path (Connected activities with Zero Slack)



**Example:**

Activity	P. Activity	$t_o$	$t_m$	$t_p$
A	-	1	1	7
B	-	1	4	7
C	-	2	2	8
D	A	1	1	1
E	B	2	5	14
F	C	2	5	8
G	D,E	3	6	15

**Step 1 - Estimated time and S.D. (or variance) calculation**

Activity	$t_o$	$t_m$	$t_p$	$t_e = \frac{t_o + 4 \cdot t_m + t_p}{6}$	$\sigma^2 = \left(\frac{t_p - t_o}{6}\right)^2$
A	1	1	7	2	1
B	1	4	7	4	1
C	2	2	8	3	1
D	1	1	1	1	0
E	2	5	14	6	4
F	2	5	8	5	1
G	3	6	15	7	4

Using these estimated time, precedence diagram can be drawn:

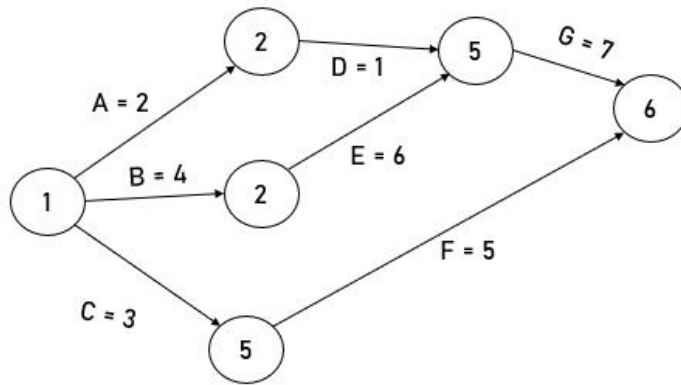

Similar to CPM method, Forward and backward pass can be conducted to identify critical path.

#### ForwardPass Method

$$E_1=0$$

$$E_2=E_1+t_1, 2 [t_1,2=A=2]=0+2=2$$

$$E_3=E_1+t_1, 3 [t_1,3=B=4]=0+4=4$$

$$E_4=E_1+t_1, 4 [t_1,4=C=3]=0+3=3$$

$$E_5=\text{Max}\{E_i+t_i,5\}[i=2,3]=\text{Max}\{E_2+t_2,5;E_3+t_3,5\}=\text{Max}\{2+1;4+6\}=\text{Max}\{3;10\}=10$$

$$E_6=\text{Max}\{E_i+t_i,6\}[i=4,5]=\text{Max}\{E_4+t_4,6;E_5+t_5,6\}=\text{Max}\{3+5;10+7\}=\text{Max}\{8;17\}=17$$

#### Backward Pass Method

$$L_6=E_6=17$$

$$L_5=L_6-t_5, 6 [t_5,6=G=7]=17-7=10$$

$$L_4=L_6-t_4, 6 [t_4,6=F=5]=17-5=12$$

$$L_3=L_5-t_3, 5 [t_3,5=E=6]=10-6=4$$

$$L_2=L_5-t_2, 5 [t_2,5=D=1]=10-1=9$$

$$L_1=\text{Min}\{L_j-t_{1,j}\}[j=2,3,4,5]=\text{Min}\{L_2-t_{1,2};L_3-t_{1,3};L_4-t_{1,4};L_5-t_{1,5}\}=\text{Min}\{9-1;4-4;12-3;10-2\}=\text{Min}\{8;0;9;8\}=0$$

#### The critical path

The critical path of the project is: 1-3-5-6 and critical activities are B, E; G. The total project time is 17

## 12.9 Queuing Theory

Queuing theory is the study of the movement of people, objects, or information through a line. Studying congestion and its causes in a process is used to help create more efficient and cost-effective services and systems.

An increase in the existing service facilities would reduce the customer's waiting time. Conversely, decreasing the level of service would result in long queue(s). This means an increase in the level of service increases the cost of operating service facilities but decreases the cost of customers waiting for service.

Queuing theory suggest a balance between these two cost. A basic queuing system consists of an arrival process (how customers arrive at the queue, how many customers are present in total), the queue itself, the service process for attending to those customers, and departures from the system.

## 12.10 Kendall Notations

It's customary to use the following symbols:

- The mean (or average) number of arrivals per time period, i.e. the mean arrival rate, is lamda.



- to represent the mean (or average) number of clients served over a given time period, i.e. the mean service rate

Queuing systems are classified as **A/B/C/D/E** according to a standard notation scheme:

- A the probability distribution for the arrival process
- B the probability distribution for the service process
- C the number of channels (servers)
- D the maximum number of customers allowed in the queuing system (either being served or waiting for service)
- E the maximum number of customers in total

Common options for A and B are:

- M for a Poisson arrival distribution (exponential interarrival distribution) or a exponential service time distribution
- D for a deterministic or constant value
- G for a general distribution (but with a known mean and variance)

If D and E are not specified then it is assumed that they are infinite.

The queue discipline is the order (or manner) in which customers from the queue are selected for service. It can be:

- First-come, first-served (FCFS)
- Last-come, first-served (LCFS)
- Service in Random Order (SIRO)
- Pre-emptive priority (or emergency)
- Non-pre-emptive priority where an important customer goes ahead in the queue, but service is started immediately on completion of the current service

Arrival pattern can have one of the following cases:

- **Balking:** Customer decides not to join the queue by seeing the number of customers already in service system.
- **Reneging:** Customer after joining the queue, waits for some time and leaves the service system due to delay in service.
- **Jockeying:** Customer moves from one queue to another thinking that he will get served faster by doing so.

### **12.11 M/M/1 : Infinite/FCFS Model**

This is a basic model of Queuing theory. Assumptions under this model are:

- Arrivals - Poisson probability distribution
- Arrivals from an infinite calling population
- Single waiting line
- Infinite capacity queue
- No balking or reneging.
- Queue discipline is 'first-come, first-served'.
- Single server or channel
- Service times follow exponential distribution
- Customers arrival is independent
- Customer's arrival rate (average number of arrivals) does not change over time.
- The average service rate is more than the average arrival rate.

Based on these assumptions, following performance measures can be derived:

## Unit 12: Project Management and Queuing Theory

Measures	Formula
Expected number of customers in the system	$L_s = \frac{\rho}{1-\rho} = \frac{\lambda}{\mu-\lambda}; \rho = \frac{\lambda}{\mu}$
Expected number of customers waiting in the queue	$L_q = \frac{\lambda}{\lambda-\mu} - \frac{\lambda}{\mu} = \frac{\lambda^2}{\mu(\mu-\lambda)}; 1-P_0 = \frac{\lambda}{\mu}$
Expected waiting time for a customer in the queue	$W_q = \lambda \left(1 - \frac{\lambda}{\mu}\right) \frac{1}{(\mu-\lambda)^2} = \frac{\lambda}{\mu(\mu-\lambda)}$ or $\frac{L_q}{\lambda}$
Expected waiting time for a customer in the system	$W_s = W_q + \frac{1}{\mu} = \frac{\lambda}{\mu(\mu-\lambda)} + \frac{1}{\mu} = \frac{1}{\mu-\lambda}$ or $\frac{L_s}{\lambda}$
The variance (fluctuation) of queue length	$\text{Var}(n) = \frac{\rho}{(1-\rho)^2} = \frac{\lambda\mu}{(\mu-\lambda)^2}$
Probability that the queue is non-empty	$P(n > 1) = 1 - P_0 - P_1$ $= 1 - \left(1 - \frac{\lambda}{\mu}\right) - \left(1 - \frac{\lambda}{\mu}\right)\left(\frac{\lambda}{\mu}\right) = \left(\frac{\lambda}{\mu}\right)^2$
Probability that the number of customers, n in the system exceeds a given number k	$P(n \geq k) = \left(\frac{\lambda}{\mu}\right)^k$ and $P(n > k) = \left(\frac{\lambda}{\mu}\right)^{k+1}$
Expected length of non-empty queue	$\frac{L_q}{P(n > 1)} = \frac{\lambda^2\mu(\mu-\lambda)}{(\lambda\mu)^2} = \frac{\mu}{\mu-\lambda}$

**Summary**

- The goal of a project management study is to schedule activities related with any project in an efficient manner so that the project is completed on or before a set deadline, at the lowest cost, and to the highest quality level possible.
- PERT and CPM are two project management approaches that are often used to highlight the logical sequence of tasks that must be completed in order to meet project objectives.
- PERT is useful for projects where there is a degree of uncertainty in estimating activity duration, such as novel types of projects that have never been undertaken before.
- CPM is beneficial for determining time-cost trade-offs for projects involving recurring operations.
- A queue forms when a customer (human beings or physical entities) who requires service is forced to wait because the number of customers outnumbers the number of service facilities, or when service facilities do not perform efficiently and take longer than expected to serve a customer.
- Queuing theory can be used in a variety of circumstances where it is impossible to correctly estimate the rate (or time) at which consumers will arrive and the rate (or time) at which the service facility or facilities will provide service.
- Models of queuing theory are classified using specific (or standard) notations, which were first specified by D.G. Kendall in the form (a/b/c). The symbols d and c were later added to Kendall's notation by A.M. Lee.

**Keywords**

- **CPM** - CPM is a technique which is used for the projects where the time needed for completion of project is already known. It is majorly used for determining the approximate time within which a project can be completed.
- **Expected time** - Assuming there are problems, the best estimate of how much time will be required to complete a task.
- **Most likely time** - Assuming there are no problems, the best or most reasonable estimate of how long it should take to complete a task.
- **PERT** - PERT is appropriate technique which is used for the projects where the time required or needed to complete different activities are not known
- **Pessimistic time** - The maximum amount of time it should take to complete a task
- **Queuing system**- A flow system in which a commodity moves through one or more channels in order to go from one point to another
- **Service pattern** - This is known as the rate of arrival of customers and can be differentiated based on haphazard or patterned arrival
- **Service in Priority** -This is a system where people having the highest priority and especially those in sensitive areas get the required service.
- **Last come first serve** - This is a system where people who come last are served at the first instance depending on their requirement.
- **First come first serve** -This is the usual technique that is followed, wherein people who have come first are served immediately.
- **Service in Priority** -This is a system where people having the highest priority and especially those in sensitive areas get the required service.
- **Last come first serve** - This is a system where people who come last are served at the first instance depending on their requirement.
- **First come first serve** - This is the usual technique that is followed, wherein people who have come first are served immediately.

**Self Assessment**

1. PERT involves \_\_\_\_\_ time estimates:
  - A. One
  - B. Two
  - C. Three
  - D. None of the above
  
2. CPM involves \_\_\_\_\_ time estimates:
  - A. One
  - B. Two
  - C. Three
  - D. None of the above
  
3. \_\_\_\_\_ is used for repetitive activities where activity durations are known with certainty:
  - A. PERT
  - B. CPM

---

*Unit 12: Project Management and Queuing Theory*

---

- C. Anyone can be used
  - D. Insufficient information
4. \_\_\_\_\_ is used where element of uncertainty is present:
- A. PERT
  - B. CPM
  - C. Anyone can be used
  - D. Insufficient information
5. If Optimistic and pessimistic timing of an activity in a PERT method is 20 days and 32 days respectively, estimated time of completion for that activity will be:
- A. 26 days
  - B. 22 days
  - C. 29 days
  - D. Insufficient information
6. If Optimistic and pessimistic timing of an activity in a PERT method is 20 days and 32 days respectively, standard deviation of that activity will be:
- A. 2 days
  - B. 4 days
  - C. 6 days
  - D. Insufficient information
7. What need to be considered in managing queue and servers?
- A. Increase in cost of adding servers
  - B. Increase in customer satisfaction
  - C. Both A & B
  - D. None of the above
8. In a bank with three cash withdrawal counters (all servicing customers), if 20 customers are in bank, what is queue length?
- A. 23
  - B. 17
  - C. 20
  - D. None of the above
9. Customer after joining the queue, waits for some time and leaves the service system due to delay in service. This is called:
- A. Balking
  - B. Reneging
  - C. Jockeying
  - D. None of the above

10. SIRO queue discipline stands for:
- A. Service in Random Order
  - B. Service in reversed order
  - C. Service in ranked order
  - D. None of the above
11. In queuing theory, which of the following can be considered as customers?
- A. Automobiles in garage
  - B. Patients in a hospital
  - C. Applicants for an Interview
  - D. All of the above
12. Kendall notation "b" stands for:
- A. Arrivals distribution
  - B. Service time
  - C. Number of service channels
  - D. None of the above
13. In queuing theory, if a customer enters every 5 minutes,  $\lambda$  (Lambda) will be:
- A. 12 customers per hour
  - B. 0.2 customers per minute
  - C. Both A & B
  - D. None of the above
14. In queuing theory, if  $\lambda$  (Lambda) = 10 customers/hr and  $\mu$  (Mu) = 20 customers/hr, expected number of customers in the system will be:
- A. 1
  - B. 0.5
  - C. 2
  - D. Zero
15. In queuing theory, if  $\lambda$  (Lambda) = 10 customers/hr and  $\mu$  (Mu) = 20 customers/hr, expected waiting time of a customers in the queue will be:
- A. 0.05
  - B. 0.5
  - C. 20
  - D. Zero

**Answers for Self Assessment**

1. C      2. A      3. B      4. A      5. D  
 6. A      7. C      8. B      9. B      10. A  
 11. D      12. B      13. C      14. A      15. A

**Review Questions**

1. Explain a real scenario where CPM technique can be applied.
2. Identify a real-life project where project duration and critical path can be calculated with PERT technique.
3. Observe any queue in public area. Identify number of servers and based on the concepts of queuing theory, suggest how number of servers can affect queue length.
4. What is traffic intensity? If traffic intensity is 0.40, what is the percentage of time a system remains idle?
5. Give two examples to illustrate the applications of queuing theory in business and industry.
6. A cold store has only one loading dock with 3 loaders. Trucks arrive at dock at an average rate of 4 trucks/hour and the arrival rate is Poisson distributed. The loading takes 10 minutes on an average and can be assumed to be exponentially distributed. The operating cost is Rs 20 /hour/truck and the loaders are paid Rs 6 each per hour. Would you advise the truck owner to add another crew of three loaders?
7. Refer the following diagram and calculate all floats:

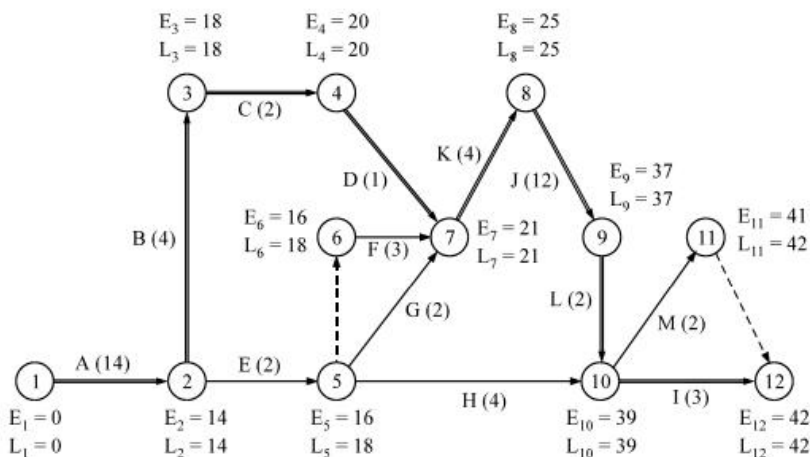

8. In above question, if activity F is removed, what will be effect on:
  - a. Total project duration
  - b. Critical path
  - c. Floats
9. What are different floats in CPM. Explain significance of all three floats.
10. What is significance of expected activity duration and variance of activity in PERT?

**Further Readings**

- Operations Research, By Sivarethinamohan, McGraw-Hill Education (India) Pvt

Limited

- Quantitative Techniques, Theory and Problems, By P. C. Tulsian, Pearson Education



### **Web Links**

- <https://www.geeksforgeeks.org/project-evaluation-and-review-technique-pert/>
- <http://people.brunel.ac.uk/~mastjb/jeb/or/queue.html>

## Unit 13: Game Theory

### CONTENTS

Objectives

Introduction

13.1 Terminologies used in Game theory

13.2 Problem solving approach

13.3 Pure Strategy (Minimax and Maximin scenario)

13.4 Mixed Strategy

Summary

Keywords

Self Assessment

Answers for Self Assessment

Review Questions

Further Readings

### Objectives

After studying this unit, you will be able to:

- Understand how best strategies are formulated in conflicting scenario
- Understand principles of game theory
- Make decisions between pure and mixed strategies

### Introduction

John von Neuman and Oskar Morgenstern developed the first general mathematical formulation of game theory, as it is known to economists, social scientists, and biologists (1944). Due to limitations in their formal structure, the theory was initially only applicable under specific and constrained circumstances. When an analyst encounters situations in which what counts as one agent's best action (for her) is dependent on expectations about what one or more other agents will do, and what counts as their best actions (for them) is similarly dependent on expectations about her, game theory is the most important and useful tool in her toolbox.

The game, which serves as a model of an interaction scenario among rational participants, is at the centre of game theory. The key to understanding game theory is that one player's payoff is dependent on the other player's strategy. The game determines the players' identities, preferences, and accessible options, as well as the impact of these strategies on the outcome. Various more needs or assumptions may be required depending on the model.

### 13.1 Terminologies used in Game theory

#### **Number of Players:**

If a game involves only two players (competitors), then it is called a **two-person game**.

If the number of players are more, the game is referred to as **n-person game**

#### **Sum of gains and losses:**

If, in a game, the sum of the gains to one player is exactly equal to the sum of losses to another player, so that, the sum of the gains and losses equals zero, then the game is said to be a **zero-sum game**



### Operations Management and Research

If the sum of the gains and losses equals zero, then the game is said to be a **zero-sum game**.

#### **Strategy:**

For each reward, a player's strategy is a list of all conceivable actions (moves, decision alternatives, or courses of action) that he is likely to do (outcome). The players are supposed to be aware of the game rules that control their decision options (or strategies). The outcome of a given strategy is also known in advance by the participants and is expressed in numerical values (e.g. money, per cent of market share or utility).

A particular strategy that a player chooses to play again and again regardless of other player's strategy, is referred as **pure strategy**

A set of strategies that a player chooses on a particular move of the game with some fixed probabilities are called **mixed strategies**.

### **13.2 Problem solving approach**

A problem can be solved using game theory through following approach:

1. Prepare pay-off matrix
2. Apply Maxi-min and Mini-max principle (Pure strategy)
3. If saddle point exist, identify value of game and write optimal strategy.
4. If no saddle point exist in above step, it is mixed strategy game.
5. If it is 2x2 matrix, use analytical or matrix method to solve.
6. If it is mxn or mx2 or 2xn matrix, reduce it to 2x2 matrix using dominance method.
7. Step 5 can be followed if matrix is reduced to 2x2 matrix format.
8. If step 6 can't be executed to reduce mx2 or 2xn matrix, use graphical method to solve the problem.
9. If mxn matrix can't be solved by any of the above methods, use sub-game method or solve problem as LPP.

### **13.3 Pure Strategy (Minimax and Maximin scenario)**

It's difficult for each player to choose the best strategy without knowing what the other player is doing. Because any player's payout table has all of the necessary information, only one player's payoff table is required to evaluate the decisions. Steps involve in pure strategy are:

- For player A the minimum value in each row represents the least gain (payoff) to him, if he chooses his particular strategy. These are written in the matrix by row minima.
- Select the strategy that gives the largest gain among the row minimum values.
- This choice of player A is called the **maximin principle**, and the corresponding gain is called the maximin value of the game.
- For player B, who is assumed to be the loser, the maximum value in each column represents the maximum loss to him, if he chooses his particular strategy. These are written in the payoff matrix by column maxima.
- Select the strategy that gives the minimum loss among the column maximum values. This choice of player B is called the minimax principle, and the corresponding loss is the **minimax value** of the game.
- If the maximin value equals the minimax value, then the game is said to have a **saddle (equilibrium) point** and the corresponding strategies are called **optimal strategies**.
- **Value of the game** is the expected payoff at the end of the game, when each player uses his optimal strategy, i.e. the amount of payoff,  $V$ , at an equilibrium point. A game may have more than one saddle points. A game with no saddle point is solved by choosing strategies with fixed probabilities.



**Example:** For the following matrix, find value of the game:

		Player B		
		$B_1$	$B_2$	$B_3$
Player A	$A_1$	20	15	12
	$A_2$	25	14	8
	$A_3$	40	2	10
	$A_4$	-5	4	11

We apply the maximin (minimax) principle to analyze the game.

		Player B			
		$B_1$	$B_2$	$B_3$	Row Minimum
Player A	$A_1$	20	15	[(12)]	[12]
	$A_2$	25	14	8	8
	$A_3$	40	2	10	2
	$A_4$	5	4	11	-5
Column Maximum		40	15	(12)	

Select minimum from the maximum of columns

$$\text{Column MiniMax} = (12)$$

Select maximum from the minimum of rows

$$\text{Row MaxiMin} = [12]$$

Here, Column MiniMax = Row MaxiMin = 12

This game has a saddle point and value of the game is 12

The optimal strategies for both players are

The player A will always adopt strategy 1

The player B will always adopt strategy 3

## 13.4 Mixed Strategy

In certain cases, no saddle point exists, i.e. maximin value  $\neq$  minimax value. In all such cases, players must choose the mixture of strategies to find the value of game and an optimal strategy. The value of game obtained by the use of mixed strategies represents the least payoff, which player A can expect to win and the least which player B can expect to lose.

### 1. Dominance Method:

Dominance method is used to reduce payoff matrix to  $m \times 2$  or  $2 \times n$  or preferably  $2 \times 2$  matrix. Following steps are involved:

- For player B, who is assumed to be the loser, if each element in a column, say  $C_r$  is greater than or equal to the corresponding element in another column, say  $C_s$  in the payoff matrix, then the column  $C_r$  is said to be dominated by column  $C_s$  and therefore, column  $C_r$  can be deleted from the payoff matrix. In other words, player B will never use the strategy that corresponds to column  $C_r$  because he will lose more by choosing such strategy.
- For player A, who is assumed to be the gainer, if each element in a row, say  $R_r$ , is less than or equal to the corresponding element in another row, say  $R_s$ , in the payoff matrix, then the row  $R_r$  is said to be dominated by row  $R_s$  and therefore, row  $R_r$  can be deleted from the

payoff matrix. In other words, player A will never use the strategy corresponding to row  $R_r$ , because he will gain less by choosing such a strategy.

- A strategy say,  $k$  can also be dominated if it is inferior (less attractive) to an average of two or more other pure strategies. In this case, if the domination is strict, then strategy  $k$  can be deleted. If strategy  $k$  dominates the convex linear combination of some other pure strategies, then one of the pure strategies involved in the combination may be deleted. The domination would be decided as per rules 1 and 2 above



**Example:** Following matrix can be reduced using dominance theory

$$\begin{array}{c} \text{Player B} \\ B_1 \quad B_2 \quad B_3 \\ \text{Player A } \begin{array}{l} A_1 \\ A_2 \\ A_3 \\ A_4 \end{array} \left[ \begin{array}{ccc} 3 & 5 & 4 \\ 5 & 6 & 2 \\ 2 & 1 & 4 \\ 3 & 3 & 5 \end{array} \right] \end{array}$$

row-3  $\leq$  row-4, so remove row-3,  $(A_3 \leq A_4: 2 \leq 3, 1 \leq 3, 4 \leq 5)$

$$\begin{array}{c} \text{Player B} \\ B_1 \quad B_2 \quad B_3 \\ \text{Player A } \begin{array}{l} A_1 \\ A_2 \\ A_4 \end{array} \left[ \begin{array}{ccc} 3 & 5 & 4 \\ 5 & 6 & 2 \\ 3 & 3 & 5 \end{array} \right] \end{array}$$

column-2  $\geq$  column-1, so remove column-2.  $(B_2 \geq B_1: 5 \geq 3, 6 \geq 5, 3 \geq 3)$

$$\begin{array}{c} \text{Player B} \\ B_1 \quad B_3 \\ \text{Player A } \begin{array}{l} A_1 \\ A_2 \\ A_4 \end{array} \left[ \begin{array}{cc} 3 & 4 \\ 5 & 2 \\ 3 & 5 \end{array} \right] \end{array}$$

row-1  $\leq$  row-3, so remove row-1,  $(A_1 \leq A_4: 3 \leq 3, 4 \leq 5)$

$$\begin{array}{c} \text{Player B} \\ B_1 \quad B_3 \\ \text{Player A } \begin{array}{l} A_2 \\ A_4 \end{array} \left[ \begin{array}{cc} 5 & 2 \\ 3 & 5 \end{array} \right] \end{array}$$

This reduced matrix can be used as a base for further calculations.

## 2. Algebraic Method:

## Unit 13: Game Theory

This method is used to determine the probability of using different strategies by players A and B. This method becomes quite lengthy when a number of strategies for both the players are more than two.



**Example:** Using algebraic method, following matrix can be evaluated:

		Player B	
		B <sub>1</sub>	B <sub>2</sub>
Player A	A <sub>1</sub>	10	70
	A <sub>2</sub>	60	20

We apply the maximin (minimax) principle to analyze the game.

		Player B		
		B <sub>1</sub>	B <sub>2</sub>	Row Minimum
Player A	A <sub>1</sub>	10	70	10
	A <sub>2</sub>	60	20	[20]
	Column Maximum	(60)	70	

Select minimum from the maximum of columns. Column MinMax = (60)

Select maximum from the minimum of rows. Row MaxiMin = [20] Here, Column MinMax ≠ Row MaxiMin ∴ This game has no saddle point.

P<sub>i</sub> is probability that player A selects i<sup>th</sup> strategy. Similarly, Q<sub>j</sub> is probability that player B selects j<sup>th</sup> strategy. Once probabilities are calculated, expected payoffs can be calculated for each player.

Here  $a = 10, b = 70, c = 60, d = 20$

$$p_1 = \frac{d - c}{(a + d) - (b + c)} = \frac{20 - 60}{(10 + 20) - (70 + 60)} = \frac{-40}{30 - 130} = 0.4$$

$$p_2 = 1 - p_1 = 1 - 0.4 = 0.6$$

$$q_1 = \frac{d - b}{(a + d) - (b + c)} = \frac{20 - 70}{(10 + 20) - (70 + 60)} = \frac{-50}{30 - 130} = 0.5$$

$$q_2 = 1 - q_1 = 1 - 0.5 = 0.5$$

$$V = \frac{a \cdot d - b \cdot c}{(a + d) - (b + c)} = \frac{(10 \times 20) - (70 \times 60)}{(10 + 20) - (70 + 60)} = \frac{200 - 4200}{30 - 130} = 40$$

### 3. Arithmetic Method:

The arithmetic method (also known as short-cut method) provides an easy method for finding optimal strategies for each player in a payoff matrix of size  $2 \times 2$ , without saddle point.

Steps involved in this method is:

Find the differences between the two values in the first row and put it against the second row of the matrix, neglecting the negative sign (if any). Find the difference between the two values in the second row and put it against first row of the matrix, neglecting the negative sign (if any).

		Firm B		
		B <sub>2</sub>	B <sub>3</sub>	
A <sub>2</sub>		12	15	14 - 10 = 4,
A <sub>3</sub>		14	10	15 - 12 = 3,
		15 - 10 = 5	14 - 12 = 2	

Probabilities may be calculated from the above weightages.



**Example:** For the following matrix, value of the game need to be calculated.

		Player B	
		B <sub>1</sub>	B <sub>2</sub>
Player A	A <sub>1</sub>	1	7
	A <sub>2</sub>	6	2

Probabilities can be calculated as:

		Player B		
		B <sub>1</sub>	B <sub>2</sub>	
Player A	A <sub>1</sub>	1	7	$ 6 - 2  = 4 \therefore p_1 = \frac{4}{6+4} = 0.4$ $ 1 - 7  = 6 \therefore p_2 = \frac{6}{6+4} = 0.6$
	A <sub>2</sub>	6	2	
		$ 7 - 2  = 5$	$ 1 - 6  = 5$	
		$\therefore q_1 = \frac{5}{5+5} = 0.5$	$\therefore q_2 = \frac{5}{5+5} = 0.5$	

Value of the game can be calculated as:

$$\therefore p_1 = \frac{4}{6+4} = 0.4 \quad \therefore q_1 = \frac{5}{5+5} = 0.5$$

$$\therefore p_2 = \frac{6}{6+4} = 0.6 \quad \therefore q_2 = \frac{5}{5+5} = 0.5$$

Expected gain of Firm A

(1)  $1 \times 0.4 + 6 \times 0.6 = 4$ , Firm B adopt B1

(2)  $7 \times 0.4 + 2 \times 0.6 = 4$ , Firm B adopt B2

Expected loss of Firm B

(1)  $1 \times 0.5 + 7 \times 0.5 = 4$ , Firm A adopt A1

(2)  $6 \times 0.5 + 2 \times 0.5 = 4$ , Firm A adopt A2

#### 4. Graphical Method:

This method is applicable for  $2 \times n$  or  $n \times 2$  matrix format for two person zero sum game.

Consider the following  $2 \times n$  payoff matrix of a game, without saddle point.

		Player B				
		B <sub>1</sub>	B <sub>2</sub>	...	B <sub>n</sub>	
Player A	A <sub>1</sub>	a <sub>11</sub>	a <sub>12</sub>	...	a <sub>1n</sub>	p <sub>1</sub>
	A <sub>2</sub>	a <sub>21</sub>	a <sub>22</sub>	...	a <sub>2n</sub>	p <sub>2</sub>
Probability		q <sub>1</sub>	q <sub>2</sub>	...	q <sub>n</sub>	

The expected payoff for player A will be:

<i>B's Pure Strategies</i>	<i>A's Expected Payoff</i>
$B_1$	$a_{11}p_1 + a_{21} p_2$
$B_2$	$a_{12}p_1 + a_{22} p_2$
$\vdots$	$\vdots$
$B_n$	$a_{1n}p_1 + a_{2n} p_2$



Example:

Following matrix may be solved using graphical method:

		Player B	
		$B_1$	$B_2$
Player A	$A_2$	3	5
	$A_3$	-1	6
	$A_4$	4	1

First, we draw two parallel lines 1 unit distance apart and mark a scale on each. The two parallel lines represent strategies of player B. If player A selects strategy A1, player B can win 3 or 5 units depending on B's selection of strategies. The value 3 is plotted along the vertical axis under strategy B1 and the value 5 is plotted along the vertical axis under strategy B2. A straight line joining the two points is then drawn. Similarly, we can plot strategies A2, A3 also.

The problem is graphed in the following figure.

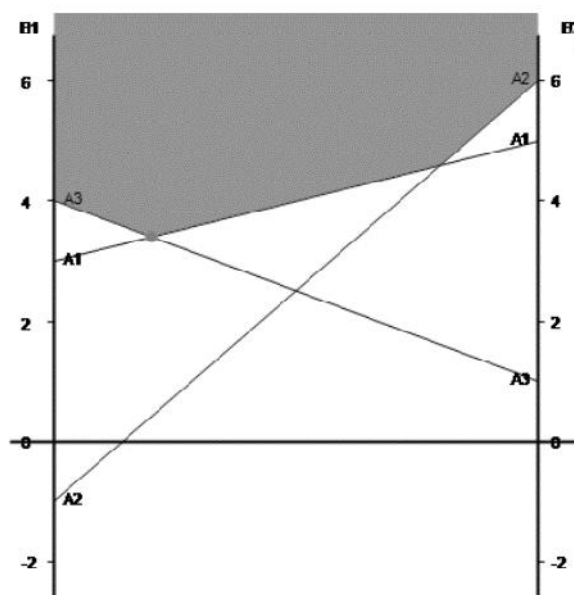

The lowest point V in the shaded region indicates the value of game. From the above figure, the value of the game is 3.4 units.

The point of optimal solution occurs at the intersection of two lines

$$E1 = 3p_1 + 5p_2$$

$$E3 = 4p_1 + p_2$$

Comparing the above two equations, we have

$$3p_1 + 5p_2 = 4p_1 + p_2$$

Substituting  $p_2 = 1 - p_1$

$$3p_1 + 5(1-p_1) = 4p_1 + (1-p_1)$$

Solving  $p_1 = 0.8$

$$p_2 = 1 - p_1 = 1 - 0.8 = 0.2$$

Substituting the values of  $p_1$  and  $p_2$  in equation E1

$$V = 3(0.8) + 5(0.2) = 3.4$$

### 5. Linear Programming Method:

The two-person zero-sum games can also be solved by linear programming. The major advantage of using linear programming technique is that it helps to solve the mixed-strategy games of larger dimension payoff matrix. Following matrix may be converted to LPP format.

		Player B		
		$B_1$	$B_2$	
Player A	$A_1$	8	1	$p_1$
	$A_3$	3	9	$p_2$
		Probability	$q_1$	$q_2$

Player A's objective is to maximize the expected gains, which can be achieved by maximizing  $V$ , i.e., it might gain more than  $V$  if company B adopts a poor strategy.

The expected gain for player A will be as follows

$$8p_1 + 3p_2 \geq V$$

$$p_1 + 9p_2 \geq V$$

Dividing the above constraints by  $V$ , we get

$$8(p_1/V) + 3(p_2/V) \geq 1$$

$$(p_1/V) + 9(p_2/V) \geq 1$$

To simplify the problem, we put

$$p_1/V = x_1, p_2/V = x_2$$

In order to maximize  $V$ , player A can

$$\text{Minimize } Z = 1/V = x_1 + x_2$$

subject to

$$8x_1 + 3x_2 \geq 1$$

$$x_1 + 9x_2 \geq 1$$

$$\text{and } x_1, x_2 \geq 0$$

player B's objective is to minimize its expected losses, which can be reduced by minimizing  $V$ , i.e., player A adopts a poor strategy.

The expected loss for player B will be as follows

$$8q_1 + q_2 \leq V$$

$$3q_1 + 9q_2 \leq V$$

Dividing the above constraints by  $V$ , we get

$$8(q_1/V) + (q_2/V) \leq 1$$

$$3(q_1/V) + 9(q_2/V) \leq 1$$

To simplify the problem, we put

$$q_1/V = y_1, q_2/V = y_2$$

In order to minimize  $V$ , player B can

$$\text{Maximize } Z = 1/V = y_1 + y_2$$

subject to

$$8y_1 + y_2 \leq 1$$

$$3y_1 + 9y_2 \leq 1$$

$$\text{and } y_1, y_2 \geq 0$$

This LPP can be solved using simplex or graphical method (if dealing with two variables).

## Summary

- A game is a contest involving two or more competitors each of whom wants to win. A theory of games provides a series of mathematical models that may be useful in explaining interactive decision-making concepts, where two or more competitors are involved under conditions of conflict and competition.
- Models provide an opportunity to a competitor to evaluate not only his personal decision alternatives (courses of action), but also the evaluation of the competitor's possible choices in order to win the game.
- The strategy for a player is the list of all possible actions (moves, decision alternatives or courses of action) that are likely to be adopted by him for every payoff (outcome). It is assumed that the players are aware of the rules of the game governing their decision alternatives (or strategies).
- A game with only two players, say A and B, is called a two-person zero-sum game, only if one player's gain is equal to the loss of other player, so that total sum is zero.

## Keywords

**Mixed strategies:** A set of strategies that a player chooses on a particular move of the game with some fixed probability are called mixed strategies.

**Payoff matrix:** The payoffs (a quantitative measure of satisfaction that a player gets at the end of the play) in terms of gains or losses, when players select their particular strategies (courses of action), can be represented in the form of a matrix, called the payoff matrix.

**Pure strategy:** A particular strategy that a player chooses to play again and again regardless of other player's strategy, is referred as pure strategy.

**Zero-sum game:** If, in a game, the sum of the gains to one player is exactly equal to the sum of losses to another player, so that, the sum of the gains and losses equals zero, then the game is said to be a zero-sum game.

**Saddle point:** Saddle point is the payoff value that represents both minimax and maximin value of the game.

**Dominance rules:** It is the procedure to reduce the size of the payoff matrix according to the tendency of players.

## Self Assessment

- 1) A common assumption about the players in a game is that
  - A. Neither player knows the payoff matrix
  - B. The players have different information about payoff matrix
  - C. Only one of the players pursues a rational strategy
  - D. The specific identity of the players is irrelevant to the play of the game
- 2) In a zero sum game,
  - A. What one player wins, the other loses
  - B. The sum of each player's winnings if the game is played many times must be zero
  - C. The game is fair-each person has an equal chance of winning
  - D. Long run profits must be zero



- 3) The prisoner's dilemma is not a constant sum game because
- Some outcomes are better than others for both players
  - The prisoner's sentences are necessarily non-zero
  - The game does not have a nash equilibrium
  - The sum of the prisoner's sentences is non zero
- 4) The saddle point in a payoff matrix is always the
- Largest number in the matrix
  - Smallest in its column and largest in row
  - Largest in column and smallest in row
  - Smaller number in the matrix
- 5) Mixed strategies are only used when a matrix game has np
- Best point
  - Maximum point
  - Minimum point
  - Saddle point
- 6) The principle of dominance are applicable when
- The payoff matrix is a profit matrix for the player A and a loss matrix for the player B
  - The payoff matrix is a profit matrix for the player B and a loss matrix for the player A
  - The payoff matrix is a profit matrix
  - The payoff matrix is a square matrix
- 7) Which of the following statements are true?
- In a two person zero sum game, gains of one player are equal to the losses of the other player
  - Every matrix game has a saddle point
  - Use of the concept of dominance in reducing the size of a matrix game may lead to the loss of the saddle point
  - A matrix game is not the same as a rectangular game
- 8) Which strategy can be eliminated by using dominance theory in the following matrix:

	$Y_1$	$Y_2$
$X_1$	9	13
$X_2$	12	8
$X_3$	6	14

- $X_1$
- $X_2$
- $Y_1$
- None of the above

	$Y_1$	$Y_2$
$X_1$	6	3
$X_2$	2	8

- 9) What is value of the following game?
- 11
  - 19
  - 4.67
  - 4.75
- 10) A two-person zero-sum game means that the
- the sum of losses to one player is equal to the sum of gains to other
  - the sum of losses to one player is not equal to the sum of gains to other
  - no any player gains or losses
  - none of these
- 11) A game is said to be fair if
- both upper and lower values of the game are the same and zero
  - upper and lower values of the game are not equal
  - upper value is more than the lower value of the game
  - none of these
- 12) What happens when maximin and minimax values of the game are same?
- no solution exists
  - solution is mixed
  - saddle point exists
  - none of these
- 13) A mixed strategy game can be solved by
- algebraic method
  - matrix method
  - graphical method
  - all of these
- 14) When no saddle point is found in a payoff matrix of a game, the value of the game is then found by
- reducing the size of the game to apply the algebraic method

Operations Management and Research

---

- B. solving any one 2x2 subgame
- C. finding the average of all the values of the payoff matrix
- D. none of these

15) One of the assumptions in the game theory is

- A. All players act rationally and intelligently
- B. The winner alone acts rationally
- C. Loser acts intelligently
- D. Both the players believe luck

**Answers for Self Assessment**

- |       |       |       |       |       |
|-------|-------|-------|-------|-------|
| 1. D  | 2. A  | 3. A  | 4. C  | 5. D  |
| 6. A  | 7. A  | 8. D  | 9. C  | 10. A |
| 11. A | 12. C | 13. D | 14. A | 15. D |

**Review Questions**

Q1. Explain the following terms:

- (i) Two-person zero-sum game,
- (ii) Principles of dominance,
- (iii) Pure strategy in game theory

Q2. Explain the theory of dominance in the solution of rectangular games.

Q3. How is the concept of dominance used in simplifying the solution of a rectangular game?

Q4. Explain: Minimax and Maximin principle used in the theory of games.

Q5. Define: (i) Competitive game; (ii) Pure strategies; (iii) Mixed strategies (iv) Two-person zero-sum (or rectangular) game, (v) Payoff matrix.

Q6. What is a game in game theory? What are the properties of a game? Explain the 'best strategy' on the basis of minimax criterion of optimality.

Q7. Define: (i) competitive game, (ii) payoff matrix, (iii) pure and mixed strategies, (iv) saddle point, (v) optimal strategies, and (vi) rectangular (or two-person zero-sum) game.

Q8. State the major limitations of the game theory.

Q9. Explain the difference between pure strategy and mixed strategy.

Q10. Game theory provides a systematic quantitative approach for analysing competitive situations in which the competitors make use of logical processes and techniques in order to determine an optimal strategy for winning

**Further Readings**

Operations Research, By Sivarethinamohan, McGraw-Hill Education (India) Pvt Limited  
Quantitative Techniques, Theory and Problems, By P. C. Tulsian, Pearson Education

**Web Links**

Game theory- <https://www.britannica.com/science/game-theory>

Game Theory- <https://www.investopedia.com/terms/g/gametheory.asp>

## Unit 14: Decision Theory

### CONTENTS

Objectives

Introduction

14.1 Steps Involved in Decision Making

14.2 Decision-Making Environments

14.3 Decision making under un-certainty

14.4 Decision Making under Risk

14.5 Decision Tree

Summary

Keywords

Self Assessment

Answers for Self Assessment

Review Questions

Further Readings

### Objectives

After studying this unit, you will be able to:

- Understand how decisions can be made when risk is involved
- Understand how decisions can be made when uncertainty is involved
- Use decision tree to make decisions

### Introduction

Whether it's a simple decision like whether to take the bus or a taxi, or a more complex decision like whether to pursue a difficult political career, decision theory is concerned with the reasons behind an agent's choices. (Note that "agent" refers to an entity capable of thought and action, which is normally a human person.) Standard thinking holds that an agent's actions are entirely determined by her beliefs, desires, or values on any particular occasion, but this is not without controversy, as will be seen below. In any event, decision theory is a theory of beliefs, desires, and other relevant attitudes as much as it is a theory of choice; what counts is how these diverse attitudes (dubbed "preference attitudes") cohere together.

Preferences and prospects are the two most important ideas in decision theory (or equivalently, options). When we say (in this article) that an agent "prefers" the "option" A over B, we imply that the agent believes A is more desirable or worthy of consideration than B. Preference is a comparison attitude, as this crude definition demonstrates. Beyond that, there is room for debate regarding what preferences over options actually entail, or, to put it another way, what it is about an agent (possibly oneself) that causes us anxiety when we discuss his or her preferences over options.

### 14.1 Steps Involved in Decision Making

Decision making involves following steps:

Identify and define the problem.

List all possible future events (not under the control of decision-maker) that are likely to occur.

Identify all the courses of action available to the decision-maker.

Express the payoffs ( $p_{ij}$ ) resulting from each combination of course of action and state of nature.

Apply an appropriate decision theory model to select the best course of action from the given list on the basis of a criterion (measure of effectiveness) to get optimal (desired) payoff.

## 14.2 Decision-Making Environments

To arrive at an optimal decision it is essential to have an exhaustive list of decision-alternatives, knowledge of decision environment, and use of appropriate quantitative approach for decision-making. The three types of decision-making environments are:

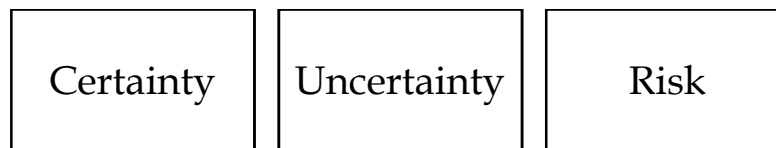

The knowledge of these environments helps in choosing the quantitative approach for decision-making.

## 14.3 Decision making under un-certainty

When probability of any outcome can not be quantified, the decision-maker must arrive at a decision only on the actual conditional payoff values, keeping in view the criterion of effectiveness (policy). Different criteria are:

Criterion	Objective	Method
Optimism (Maximax or Minimin)	The opportunity to achieve the largest possible profit (maximax) or the lowest possible cost (minimin).	<ol style="list-style-type: none"> <li>1. Locate the maximum (or minimum) payoff values corresponding to each decision alternative.</li> <li>2. Select a decision alternative with best payoff value (maximum for profit and minimum for cost)</li> </ol>
Pessimism (Maximin or Minimax)	Earn no less (or pay no more) than some specified amount. decision alternative that represents the maximum of the minima (or minimum of the minima in case of loss) payoff in case of profits.	<ol style="list-style-type: none"> <li>1. Locate the minimum (or maximum in case of profit) payoff value in case of loss (or cost) data corresponding to each decision alternative.</li> <li>2. Select a decision alternative with the best payoff value (maximum for profit and minimum for loss or cost).</li> </ol>
Equal Probabilities (Laplace)	Assumed that all states of nature will occur with equal probability	<ol style="list-style-type: none"> <li>1. Equal probability value to each state of nature</li> <li>2. Compute the expected (or average)</li> </ol>

## Unit 14: Decision Theory

		<p>payoff for each alternative (course of action)</p> <p>3. Select the best expected payoff value (maximum for profit and minimum for cost).</p>
Coefficient of Optimism (Hurwicz)	A decision-maker should be neither completely optimistic nor pessimistic and, therefore, must display a mixture of both	<p>1. Decide the coefficient of optimism <math>\alpha</math> (alpha) and then coefficient of pessimism <math>(1 - \alpha)</math>.</p> <p>2. For each decision alternative select the largest and lowest payoff value and multiply these with <math>\alpha</math> and <math>(1 - \alpha)</math> values, respectively.</p> <p>3. Then calculate the weighted average, H by using above formula.</p> <p>4. Select an alternative with best weighted average payoff value.</p>
Regret (Savage)	Decision-maker regrets for choosing wrong decision alternative resulting in an opportunity loss of payoff. He always intends to minimize this regret.	<p>1. Find the best payoff corresponding to each state of nature.</p> <p>2. Subtract all other payoff values in that row from this value.</p>



**Example:** Selecting the best strategy in the following condition:

State of Nature	Strategies		
	A	B	C
X	70	50	30
Y	30	45	30
Z	15	0	30

**Maximin Criterion**

State of Nature	Strategies		
	A	B	C
X	70	50	30
Y	30	45	30
Z	15	0	30
Column Min.	15	0	30

Max. (Min. column payoff) = 30. C strategy may be adopted.

**Maximax Criterion**

State of Nature	Strategies		
	A	B	C
X	70	50	30
Y	30	45	30
Z	15	0	30
Column Max.	70	50	30

Max. (Max. column payoff) = 70. A strategy may be adopted.

**Minimax Regret Criterion**

Opportunity loss table

State of Nature	Strategies		
	A	B	C
X	$70 - 70 = 0$	$70 - 50 = 20$	$70 - 30 = 40$
Y	$45 - 30 = 15$	$45 - 45 = 0$	$45 - 30 = 15$
Z	$30 - 15 = 15$	$30 - 0 = 30$	$30 - 30 = 0$
Column Max. Regret	15	0	30

Min. (Max. column payoff) = 15. A strategy may be adopted.

**Laplace Criterion**

State of Nature	Strategies		
	A	B	C
X	70	50	30
Y	30	45	30
Z	15	0	30
Column Average	38.3	31.7	30

Max. (Avg. payoff) = 38.3. A strategy may be adopted

**Hurwicz Criterion (Alpha = 0.6)**

State of Nature	Strategies		
	A	B	C
X	70	50	30
Y	30	45	30
Z	15	0	30



Column Max.	70	50	30
$\alpha$ . Max	42	30	18
Column Min.	15	0	30
$(1 - \alpha)$ . Min	6	0	12
$[\alpha \cdot \text{Max}] + [(1 - \alpha) \cdot \text{Min}]$	48	30	30

Max. (Wt. Avg. payoff) = 48. A strategy may be adopted.

## 14.4 Decision Making under Risk

In this decision-making environment, the decision-maker has enough knowledge to assign a probability to each possible outcome (state of nature). Knowing the probability distribution of events (natural states), the decision-maker must choose a course of action that yields the highest expected (average) payoff value. The expected payout is the total of all possible weighted payoffs as a result of selecting a choice option.

### Expected monetary value

The expected monetary value (EMV) for a given course of action is obtained by adding payoff values multiplied by the probabilities associated with each state of nature. Steps involved are:

- Create a payoff matrix that lists all possible actions and natural states.
- Calculate the conditional payoff values for each possible combination of course of action and state of nature, as well as the odds of each state of nature occurring.
- Multiply the conditional payoffs by the related probabilities and sum these weighted values for each path of action to get the EMV for each course of action.
- Decide on the line of action that will result in the best EMV.

### Expected opportunity loss

The expected opportunity loss (EOL), often known as the expected value of regret, is a different decision criterion for risky decisions. The difference between the highest profit (or payout) and the actual profit as a result of taking a given course of action in a particular condition of nature is known as the EOL. As a result, EOL is the amount of payment lost as a result of failing to choose a course of action that yields the minimal payout in a given state of nature. It is preferable to take a course of action that results in the shortest possible EOL.

Steps involved are:

- Create a conditional payoff values matrix with the accompanying probability for each course of action and state of nature combination.
- Subtract each reward from the maximum payoff to get the conditional opportunity loss (COL) values for each state of nature.
- Multiply the likelihood of each state of nature with the COL value, then add the values to get the EOL for each course of action.
- Choose a course of action with the shortest possible EOL.

### Expected value of perfect information

The utmost amount of money required to obtain extra information about the occurrence of distinct states of nature before making a decision is known as the expected value of perfect information (EVPI). It is simple to choose a course of action that delivers the intended payoff in the presence of any state of nature if decision-makers have perfect (full and precise) information about the occurrence of various states of nature.

$EVPI = (\text{Expected profit with perfect information}) - (\text{Expected profit without perfect information})$



**Example:** In the following scenario, value of perfect information may be calculated as:

Nature	Probability	Decision		
		D1	D2	D3
N1	0.3	-20	-50	200
N2	0.4	200	-100	-50
N3	0.3	400	600	300

EMV Calculation:

Nature	Probability	Decision			Expected Payoff		
		D1	D2	D3	D1	D2	D3
N1	0.3	-20	-50	200	-6	-15	60
N2	0.4	200	-100	-50	80	-40	-20
N3	0.3	400	600	300	120	180	90
				EMV (Sum)	194	125	130

D1 decision may be taken.

In case of perfect information, highest payoff may be targeted.

Nature	Probability	Expected Payoff			Highest Expected Payoff
		D1	D2	D3	
N1	0.3	-6	-15	60	60
N2	0.4	80	-40	-20	80
N3	0.3	120	180	90	180
	Total	194	125	130	320 = EPPI

Expected Payoff with perfect information (EPPI) = 320

Highest Expected monetary value (EMV) = 194

Expected value of perfect information (EVPI)

$$= \text{EPPI} - \text{EMV} = 320 - 194 = 126$$

## 14.5 Decision Tree

Posterior probabilities are the revised probabilities of the states of nature obtained after conducting a test to improve the prior probabilities of respective nature. Baye's decision rule uses the prior probabilities to determine the expected payoff for each decision alternatives and then chooses the one with the largest expected payoff.

Each joint probability can be expressed as the product of a known marginal (prior) and conditional probability, i.e.,

$$P(A_i \cap B) = P(A_i) \times P(B | A_i)$$

A decision tree analysis involves the construction of a diagram that shows, at a glance, when decisions are expected to be made - in what sequence, their possible outcomes, and the corresponding payoffs.

There are two types of nodes:

- **A decision node** (represented by a square): Represents a point of time where a decision-maker can select one alternative course of action.
- **The chance node** (represented by a circle): Indicates a point of time where the decision-maker will discover the response to his decision.

There are two types of branches:

**Decision branch:** It is the branch leading away from a decision node. It represents a course of action that can be chosen at a decision point. Expected value is calculated for all decision branches emerging from a decision node. Branch with highest expected payoff is preferred.

## Unit 14: Decision Theory

**Chance branch:** It is the branch leading away from a chance node. It represents the state of nature of a set of chance events. Total expected payoffs are calculated by taking sum of expected payoffs on each chance branch, emerging from the chance node.

The decision tree utilizes the concept of 'rollback' to solve a problem. The decision tree utilizes probability factors as a means of arriving at a final answer. Example is as followed:

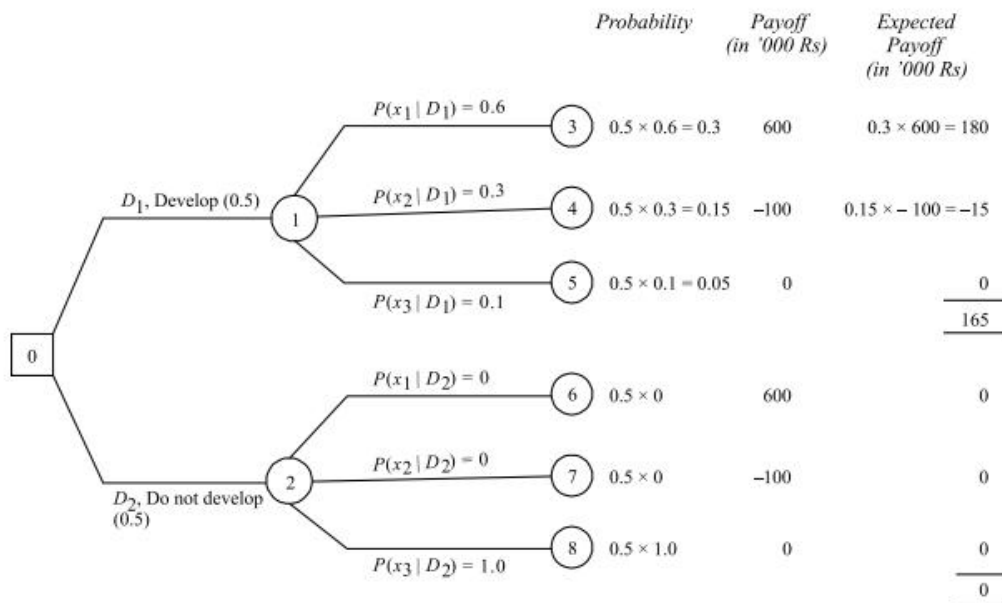

## Summary

- Decision analysis is a method of analysing decision alternatives in terms of projected outcomes.
- Decision theory refers to a set of approaches for making decisions in the face of ambiguity and risk.
- In circumstances where an issue entails a series of decisions, a decision tree graphically depicts the path of decision and random events (including a decision on whether to obtain additional information).
- Decision theory is a descriptive and prescriptive business modelling approach for categorising knowledge levels and comparing predicted outcomes from various courses of action.

## Keywords

**Decision making under certainty:** It is an environment in which future outcomes or states of nature are known.

**Decision making under risk:** It is an environment in which the probability of outcomes or states of nature can be quantified

**Decision making under uncertainty:** It is an environment in which the probability of outcomes or states of nature can not be quantified.

**Decision tree:** Decision tree is the graphical display of the progression of decision and random events

**EMV:** Expected monetary value is obtained by adding payoffs for each course of action, multiplied by the probabilities associated with each state of nature.

**EVPI:** Expected value of perfect information is an average (or expected) value of an additional information if it were of any worth

**Posterior probabilities:** Posterior probabilities are the revised probabilities of the states of nature obtained after conducting a test to improve the prior probabilities of respective nature

### **Self Assessment**

- 1) A type of decision-making environment is
  - A. certainty
  - B. uncertainty
  - C. risk
  - D. all of the above
  
- 2) Decision theory is concerned with
  - A. methods of arriving at an optimal decision
  - B. selecting optimal decision in sequential manner
  - C. analysis of information that is available
  - D. all of the above
  
- 3) Which of the following criterion is not used for decision-making under uncertainty?
  - A. maximin
  - B. maximax
  - C. minimax
  - D. minimize expected loss
  
- 4) Which of the following criterion is not applicable to decision making under risk?
  - A. maximize expected return
  - B. maximize return
  - C. minimize expected regret
  - D. knowledge of likelihood occurrence of each state of nature
  
- 5) The minimum expected opportunity loss (EOL) is
  - A. equal to EVPI
  - B. minimum regret
  - C. equal to EMV
  - D. both (a) and (b)
  
- 6) The decision-making criterion that should be used to achieve maximum long-term payoff is
  - A. EOL
  - B. EMV
  - C. Hurwicz
  - D. Maximax
  
- 7) Essential characteristics of a decision model are
  - A. states of nature
  - B. decision alternatives
  - C. payoff

- D. all of the above
- 8) The difference between the expected profit under conditions of risk and the expected profit with perfect information is called
- A. expected value of perfect information
  - B. expected marginal loss
  - C. expected opportunity loss
  - D. none of the above
- 9) The value of the coefficient of optimism ( $\alpha$ ) is needed while using the criterion of
- A. equally likely
  - B. maximin
  - C. realism
  - D. minimax
- 10) A situation in which a decision maker knows all of the possible outcomes of a decision and also knows the probability associated with each outcome is referred to as
- A. certainty.
  - B. risk.
  - C. uncertainty.
  - D. strategy.
- 11) Which of the following methods of selecting a strategy is consistent with risk averse behavior?
- A. If two strategies have the same expected profit, select the one with the smaller standard deviation.
  - B. If two strategies have the same standard deviation, select the one with the smaller expected profit.
  - C. Select the strategy with the larger coefficient of variation.
  - D. All of the above are correct.
- 12) Strategy A has an expected value of 10 and a standard deviation of 3. Strategy B has an expected value of 10 and a standard deviation of 5. Strategy C has an expected value of 15 and a standard deviation of 10. Which one of the following statements is true?
- A. A risk averse decision maker will always prefer A to B, but may prefer C to A.
  - B. A risk neutral decision maker will always prefer C to A or B.
  - C. A risk seeking decision maker will always prefer C to A or B.
  - D. All of the above are correct.
- 13) A situation in which a decision maker must choose between strategies that have more than one possible outcome when the probability of each outcome is unknown is referred to as
- A. diversification.
  - B. certainty.
  - C. risk.
  - D. uncertainty.

14) If a decision maker is risk averse, then the best strategy to select is the one that yields the

- A. highest expected payoff.
- B. lowest coefficient of variation.
- C. highest expected utility.
- D. lowest standard deviation

15) A risk-return tradeoff function

- A. shows the minimum expected return required to compensate an investor for accepting various levels of risk.
- B. slopes upward for a risk averse decision maker.
- C. is horizontal for a risk neutral decision maker.
- D. All of the above are correct.

### **Answers for Self Assessment**

- |       |       |       |       |       |
|-------|-------|-------|-------|-------|
| 1. D  | 2. D  | 3. D  | 4. B  | 5. D  |
| 6. D  | 7. D  | 8. A  | 9. C  | 10. B |
| 11. A | 12. B | 13. D | 14. C | 15. D |

### **Review Questions**

- Q1. Given the complete set of outcomes in a certain situation, how is the EMV determined for a specific course of action? Explain in your own words.
- Q2. Explain the difference between expected opportunity loss and expected value of perfect information.
- Q3. Indicate the difference between decision-making under risk, and uncertainty, in statistical decision theory.
- Q4. Briefly explain 'expected value of perfect information' with examples.
- Q5. Describe a business situation where a decision-maker faces a decision under uncertainty and where a decision based on maximizing the expected monetary value cannot be made. How do you think the decision-maker should make the required decision?
- Q6. Discuss the difference between decision-making under uncertainty, under uncertainty and under risk.
- Q7. What techniques are used to solve decision-making problems under uncertainty? Which technique results in an optimistic decision? Which technique results in a pessimistic decision?
- Q8. Explain the various quantitative methods that are useful for decision-making under uncertainty.
- Q9. What is a scientific decision-making process? Discuss the role of the statistical method in such a process.
- Q10. Give an example of a good decision that you made, which resulted in a bad outcome. Also give an example of a good decision that you made and that had a good outcome. Why was each decision good or bad?

**Further Readings**

Operations Research, By Sivarethinamohan, McGraw-Hill Education (India) Pvt Limited  
Quantitative Techniques, Theory and Problems, By P. C. Tulsian, Pearson Education

**Web Links**

1. Decision Theory Approach in Management-<https://commercemates.com/decision-theory-approach-in-management-2/>
2. Decision Theory- <https://www.merospark.com/content/388/decision-theory/>

**LOVELY PROFESSIONAL UNIVERSITY**

Jalandhar-Delhi G.T. Road (NH-1)

Phagwara, Punjab (India)-144411

For Enquiry: +91-1824-521360

Fax.: +91-1824-506111

Email: [odl@lpu.co.in](mailto:odl@lpu.co.in)